

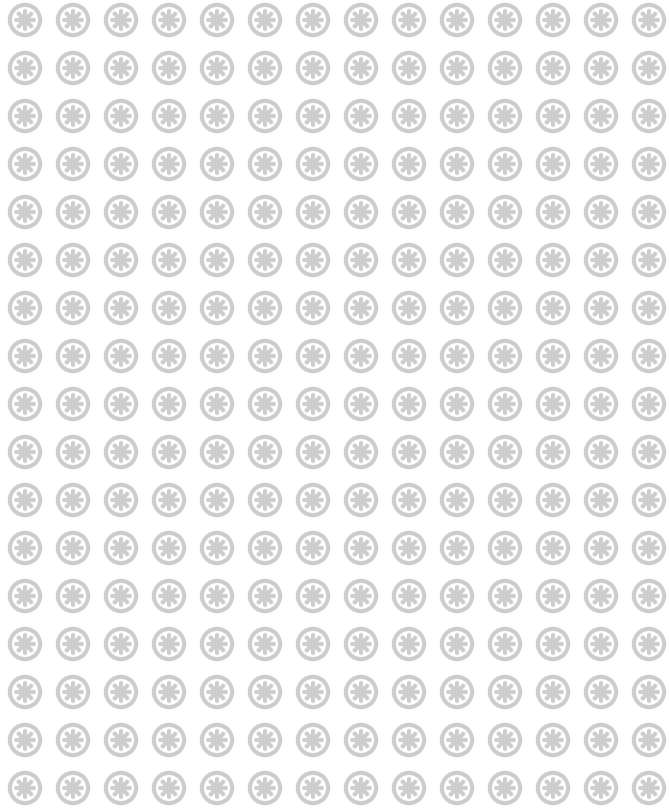

CONCRETE & DESIGN
COLLECTION



CONCRETA



CONCRETA

Una collezione “effetto cemento” dall’aspetto elegante e sofisticato che interpreta perfettamente la corrente minimalista contemporanea, ancora più accentuata dal grande formato.

La texture dall’aspetto glamour e vissuto, volutamente imperfetta, risulta morbida e piacevole al tatto, rispetta le caratteristiche visive del cemento ma con i vantaggi del grès porcellanato anche in una finitura antiscivolo disponibile in 3 colori. Una collezione completa, disponibile in 4 spessori capace di garantire ed esaltare la continuità tra interno ed esterno.

A collection that reproduces a “cement effect” with an elegant and sophisticated look that perfectly interprets the contemporary minimalist current, even more accentuated by the large size.

The texture with a glamour and lived-in look, deliberately imperfect, is soft and pleasant to the touch, respects the visual characteristics of the cement but with the advantages of porcelain stoneware also in a antislip finishing available in 3 colours. A complete collection, available in 4 thicknesses, able to guarantee and enhance the continuity between inside and outside.

Une collection « effet béton » au look élégant et sophistiqué qui interprète parfaitement la tendance minimaliste contemporaine, ultérieurement accentuée par le grand format.

La texture, à l’aspect glamour et vécu, est volontairement imparfaite, douce et agréable au toucher, respectant les caractéristiques visuelles du béton, mais avec les avantages du grès cérame également dans une finition antidérapante disponible en 3 couleurs. Une collection complète, disponible en 4 épaisseurs, capable de garantir et de renforcer la continuité entre l’intérieur et l’extérieur.

Eine Kollektion mit „Zementeffekt“ und einem eleganten und raffinierten Look, der die zeitgenössische minimalistische Strömung am Besten interpretiert, betont durch das grosse Format.

Die Textur mit einem glamour und lebendiges Aussehen, das bewusst nicht perfekt ist, sich weich und angenehm anfühlt, respektiert die optischen Eigenschaften des Zements, aber mit den Vorteilen des Feinsteinzeuges, und ist auch in der rutschhämmenden Oberfläche in 3 Farben verfügbar. Eine komplette Kollektion, verfügbar in 4 Stärken, um die Kontinuität zwischen Innen- und Aussenbereich zu gewährleisten.

100% Made in Italy



RIVESTIMENTO - WALL: GRIGIO SCURO 120x280 Nat. Ret. - GRIGIO SCURO Coprispigolo 0,8x120 Nat. Ret.
PAVIMENTO - FLOOR: GRIGIO SCURO 120x120 Nat. Ret. - GRIGIO SCURO Mosaico (3x3) 30x30 Nat. Ret.



GRIGIO SCURO 120x280 Nat. Ret. - GRIGIO SCURO Coprispigolo 0,8x120 Nat. Ret.





INDOOR
GRIGIO SCURO Muretto 15x60 Nat. Ret.
GRIGIO SCURO 120x120 Nat. Ret.
GRIGIO SCURO Coprispigo 1,4x120 Nat. Ret.
TAVOLINO , COFFEE TABLE
STATUARIO 6 mm Lucidato Ret.

OUTDOOR
GRIGIO SCURO 120x120 Nat. Ret. R11







INDOOR
GRIGIO CHIARO 120x120 - Nat. Ret.

OUTDOOR
GRIGIO CHIARO 120x120 - 20 mm Nat. Ret. R11

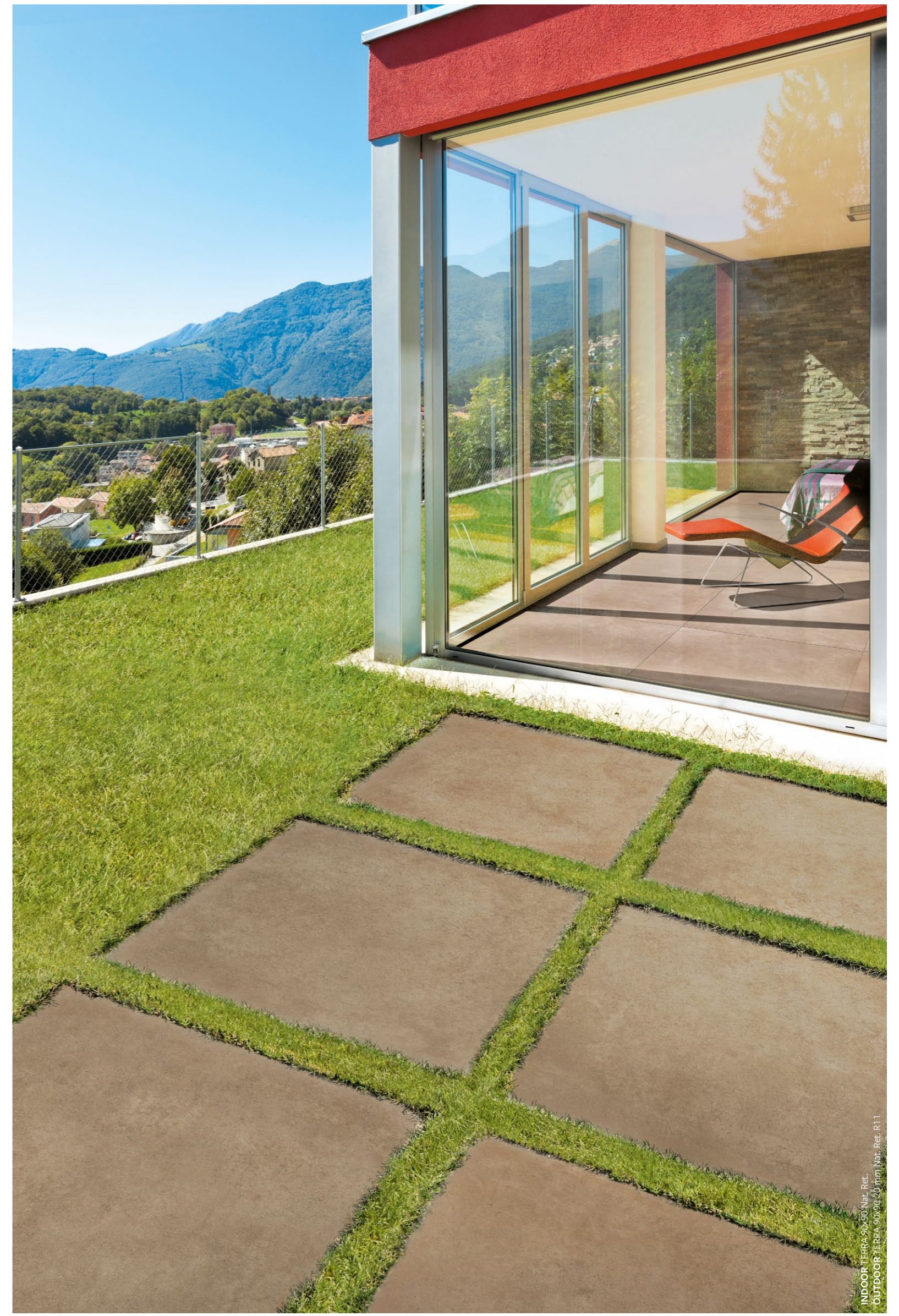

INDOOR TERRA 90x90 Nat. Ret.
OUTDOOR TERRA 90x90 20 mm Nat. Ret. R11



INDOOR:
GRIGIO CHIARO 90x90 Nat. Ret.

OUTDOOR:
GRIGIO CHIARO 90x90 20 mm Nat. Ret. R11 - GRIGIO CHIARO Griglia 20x60 20 mm Nat. Ret. R11
GRIGIO CHIARO Gradone svasato bordo piscina 30x90 20 mm Nat. Ret. R11

FORMATI

Sizes / Formats / Formate

- 6 mm . 120x280 - 48"x110"
 10 mm . 120x120 - 48"x48" / 90x90 - 35½"x35½" / 45x90 - 18"x35½" / 60x120 - 24"x48" / 60x60 - 24"x24" / 30x60 - 12"x24"
 10 mm R11. 45x90 - 18"x35½" / 30,2x60,4 - 12"x24"
 20 mm R11. 120x120 - 48"x48" / 90x90 - 35½"x35½" / 60x60 - 24"x24"
 30 mm R11. 90x90 - 35½"x35½" / 60x60 - 24"x24"

COLORI

Colours / Couleurs / Farben



GRIGIO CHIARO

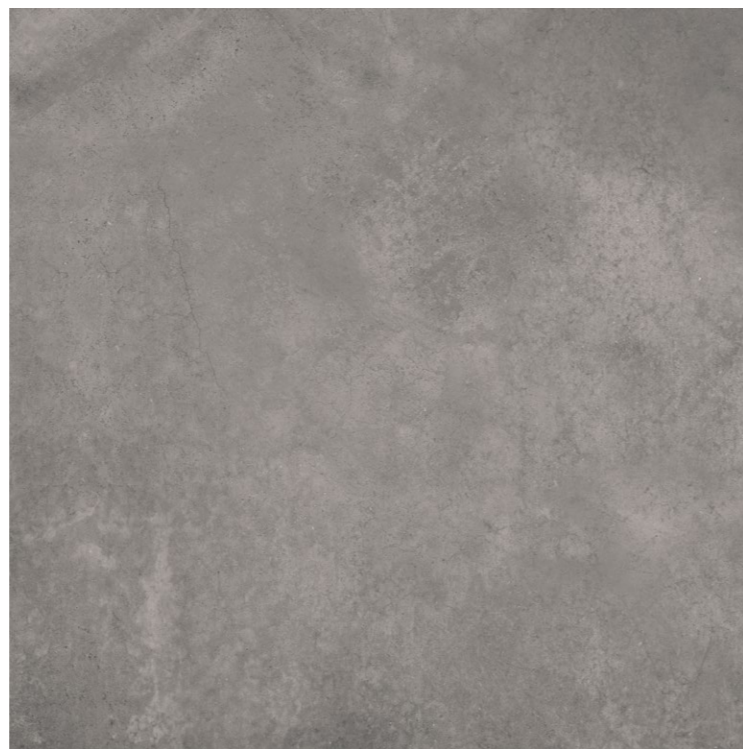

GRIGIO SCURO



TERRA

CONTINUITÀ PROGETTUALE INDOOR-OUTDOOR

Design continuity indoors and out / Continuité conceptuelle à l'intérieur et à l'extérieur / Entwurfskontinuität im innen- und Aussenbereich



INDOOR



Soluzioni contemporanee per l'interior design
 Contemporary solutions for interior design.
 Solutions contemporaines pour le design intérieur.
 Zeitgemäße Lösungen für das Interior Design.



OUTDOOR



Versatilità e prestazioni per la progettazione in esterna
 Versatility and performance for outdoor design.
 Polyvalence et performance pour l'aménagement extérieur.
 Vielseitigkeit und Leistungen für Outdoor-Design.

SISTEMI DI POSA

Laying systems / Systemes de pose / Verlegearten

Posa su erba
 Laying on grass
 Pose sur l'herbe
 Verlegung auf Wiese

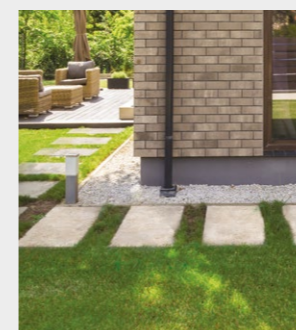

Posa su sabbia
 Laying on sand
 Pose sur sable
 Verlegung auf Sand

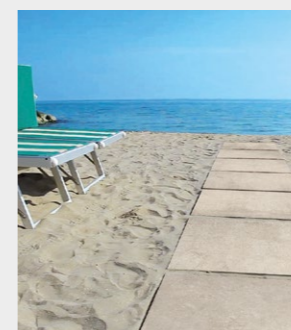

Posa sopraelevata
 Raised laying
 Pose surélevée
 Verlegung auf Stelzlägern

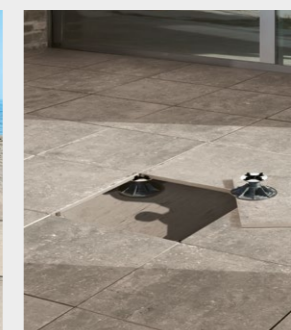

Posa su ghiaia
 Laying on gravel
 Pose sur gravier
 Verlegung auf Kies



Posa tradizionale
 Standard laying
 Pose traditionnelle
 Herkömmliche Verlegung

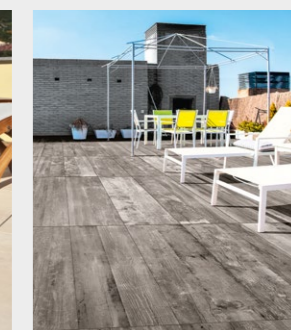

Spessore . Thickness . Epaisseur . Stärke - 6 mm

Lastre in gres porcellanato pressate a secco. Dry-pressed porcelain stoneware slabs. Dalles en grès cérame pressées à sec. Trocken gepresste Platten aus Feinsteinzeug.

Spessore . Thickness . Epaisseur . Stärke - 10 mm

Gres porcellanato colorato in massa. Full-body coloured porcelain stoneware. Grès cérame coloré dans la masse. In der Masse gefärbtes Feinsteinzeug.

INDOOR

TABELLA RIEPILOGATIVA
Summary table
Tableau récapitulatif
Zusammenfassende Tabelle

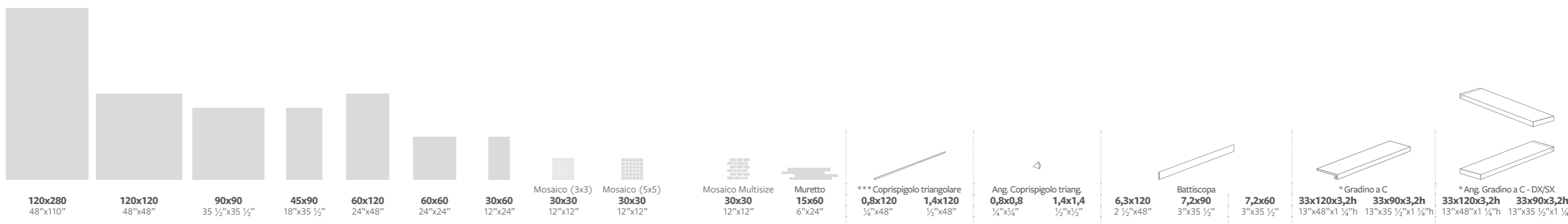

Spessore - Thickness - Epaisseur - Stärke		6 mm	10 mm	10 mm	10 mm	10 mm	10 mm	10 mm	10 mm	10 mm	10 mm	10 mm	6 mm	10 mm	6 mm	10 mm	10 mm	10 mm	10 mm	10 mm	10 mm	10 mm	10 mm		
	GRIGIO CHIARO □ Nat. Ret.	119140	119109	119010	119151	119042	119037	119165	119086	119185		119090	119190	119197	119207	119202	119212	119226	119221	119232	119255	119240	DX 119260 SX 119265	DX 119245 SX 119250	
		GRIGIO SCURO □ Nat. Ret.	119141	119107	119009	119152	119041	119035	119166	119085	119186		119089	119191	119198	119208	119203	119213	119227	119222	119233	119256	119241	DX 119261 SX 119266	DX 119246 SX 119251
		TERRA □ Nat. Ret.	119142	119105	119008	119153	119040	119033	119167	119083	119187		119091	119192	119199	119209	119204	119214	119228	119223	119234	119257	119242	DX 119262 SX 119267	DX 119247 SX 119252
MQ x pezzo - Sqm x pcs		3,36																							
Kg x pezzo - Kg x pcs		48,6																							
N°																									
m²		Cassa Crate 292x145x34h	Pallet speciale Special pallet 123x144	Pallet 95x95	Pallet 94x120	Pallet 80x120	Pallet 80x120	Pallet 80x120	Pallet 80x120	Pallet 80x120	Pallet 80x120	Pallet 80x120	Pallet 80x120	Pallet 80x120	Pallet 80x120	Pallet 80x120	Pallet 80x120	Pallet 80x120	Pallet 80x120	Pallet 80x120	Pallet 80x120	Pallet 80x120	Pallet 80x120		
Kg		20	20	20	20	20	20	20	20	20	20	20	20	20	20	20	20	20	20	20	20	20	20		
Imballo (tara) - Packaging (tare)		(90)	(36)	(20)	(20)	(20)	(20)	(20)	(20)	(20)	(20)	(20)	(20)	(20)	(20)	(20)	(20)	(20)	(20)	(20)	(20)	(20)	(20)		
N°																									
m²		Cavalletto A-Frame 75x290x145h																							
** Kg		44																							
Imballo (tara) - Packaging (tare)		(90)																							

I pesi riportati in tabella sono indicativi e potrebbero essere soggetti a leggere variazioni.
The weights stated in the chart may undergo slight changes for production reasons.
Les poids indiqués dans le tableau peuvent subir de légères variations pour des raisons de production.
Die in der Tabelle angegebenen Gewichte können aus Produktionsgründen geringfügigen Abweichungen unterliegen.

Non si garantisce l'abbinabilità tra fondi di spessori diversi e tra fondo e pezzo speciale.
It is not guaranteed that background tiles with different thicknesses can be used together, nor is it guaranteed for background tiles and trims.
Nous ne garantissons pas la possibilité de combiner des carrelages de sol de différentes épaisseurs et un carrelage de sol avec une pièce spéciale.
Die Kombinierbarkeit von Fliesen unterschiedlicher Stärke sowie zwischen Fliese und Formteil kann nicht garantiert werden.

* A disposizione solo su richiesta. Tempi di consegna 30 gg.
Available upon request only. Delivery terms: 30 days.
Disponible seulement sur requête. Délais de livraison: 30 jours.
Verfügbar auf Anfrage. Lieferzeit: 30 Tage.

□ Naturale e rettificato.
Natural and rectified.
Natur et rectifié.
Natur Oberfläche und kalibriert.

** Il peso è comprensivo dell'imballo.
The total weight includes the packaging.
Le poids comprend aussi l'emballage.
Das Gesamtgewicht enthält auch die Verpackung.

○ Nuova pallettizzazione disponibile ad esaurimento dello stock esistente.
New pallet configuration once current stock fully exhausted.
Nouvelle palettisation disponible jusqu'à épuisement du stock existant.
Neue Palettierung verfügbar solange der Vorrat reicht.

*** Vendita a scatola completa.
Full box sale.
Vente à la boîte complète.
Volle Kartons.

Spessore . Thickness . Epaisseur . Stärke - 10 mm R11 / 20 mm R11 / 30 mm R11
Gres porcellanato colorato in massa. Full-body coloured porcelain stoneware. Grès cérame coloré dans la masse. In der Masse gefärbtes Feinsteinzeug.

OUTDOOR

TABELLA RIEPILOGATIVA
 Summary table
 Tableau récapitulatif
 Zusammenfassenden Tabelle

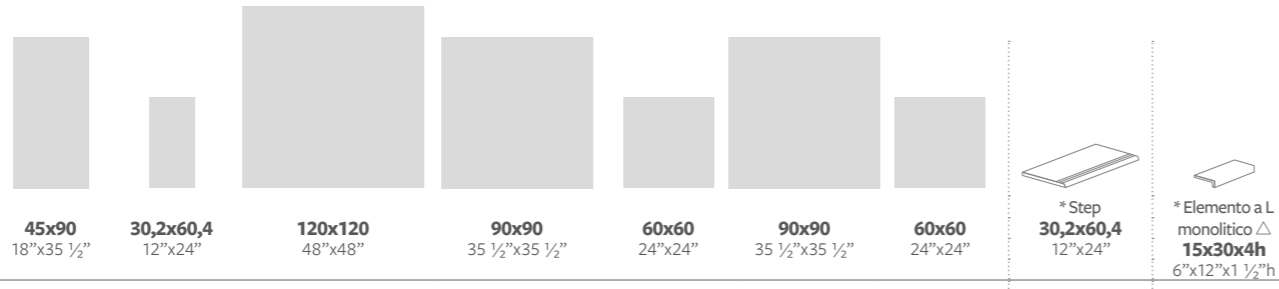

Spessore - Thickness - Epaisseur - Stärke		10 mm	10 mm	20 mm	20 mm	20 mm	30 mm	30 mm	10 mm	9,5 mm
GRIGIO CHIARO R11	□ Nat. Ret.	119156		119103	119006	119031	119003	119028		
	■ Nat. Nat.		119175						119270	119275
GRIGIO SCURO R11	□ Nat. Ret.	119157		119102	119005	119030	119002	119027		
	■ Nat. Nat.		119176						119271	119276
TERRA R11	□ Nat. Ret.	119158		119101	119004	119029	119001	119026		
	■ Nat. Nat.		119177						119272	119277
		Pallet	Pallet	Pallet speciale Special pallet	Pallet	Pallet	Pallet	Pallet	Pallet	Pallet
		94x120	80x120	123x123	94x94	80x120	95x95	65x120	80x120	80x120
N°										
m²										
Kg										
		3	6	1	1	2	1	1	6	6
m² x		1,22	1,1	1,44	0,81	0,72	0,81	0,36	1,1	
Kg x		26	22,7	68	37	30	55	25	22,7	7,5
		32	40	18	30	32	20	44	40	
m² x		38	44	25,92	24,30	23,04	16,20	15,84	44	
** Kg x		852	928	1255	1130	996	1120	1116	928	
h x		60	76	55	80	76	78	84	76	
Imballo (tara) - Packaging (tare)		(20)	(20)	(31)	(20)	(20)	(20)	(16)	(20)	(20)

I pesi riportati in tabella sono indicativi e potrebbero essere soggetti a leggere variazioni.
 The weights stated in the chart may undergo slight changes for production reasons.
 Les poids indiqués dans le tableau peuvent subir de légères variations pour des raisons de production.
 Die in der Tabelle angegebenen Gewichte können aus Produktionsgründen geringfügigen Abweichungen unterliegen.

Non si garantisce l'abbinabilità tra fondi di spessori diversi e tra fondo e pezzo speciale.
 It is not guaranteed that background tiles with different thicknesses can be used together, nor is it guaranteed for background tiles and trims.
 Nous ne garantissons pas la possibilité de combiner des carrelages de sol de différentes épaisseurs et un carrelage de sol avec une pièce spéciale.
 Die Kombinierbarkeit von Fliesen unterschiedlicher Stärke sowie zwischen Fliese und Formteil kann nicht garantiert werden.

○ Nuova pallettizzazione disponibile ad esaurimento dello stock esistente.
 New pallet configuration once current stock fully exhausted.
 Nouvelle palettisation disponible jusqu'à épuisement du stock existant.
 Neue Palettierung verfügbar solange der Vorrat reicht.

* A disposizione solo su richiesta. Tempi di consegna 30 gg.
 Available upon request only. Delivery terms: 30 days.
 Disponible seulement sur requête. Délais de livraison: 30 jours.
 Verfügbar auf Anfrage. Lieferzeit: 30 Tage.

** Il peso è comprensivo dell'imballo.
 The total weight includes the packaging.
 Le poids comprend aussi l'emballage.
 Das Gesamtgewicht enthält auch die Verpackung.

□ Naturale e rettificato.
 Natural and rectified.
 Naturel et rectifié.
 Natur Oberfläche und kalibriert.

■ Naturale e naturale.
 Natural and natural.
 Naturel et naturel.
 Natur natur.

△ Monolitico.
 Monolithic step.
 Monolitico.
 Monolitische Stufenplatte.



GRIGIO SCURO 90x90 - 30 mm Nat. Ret. R11

Spessore . Thickness . Epaisseur . Stärke - 20 mm R11

Gres porcellanato colorato in massa. Full-body coloured porcelain stoneware. Grès cérame coloré dans la masse. In der Masse gefärbtes Feinsteinzeug.

Pezzi speciali per esterno

Special pieces for outdoor - Pièces spéciales pour extérieur - Formteile für Aussenbereich

		* Gradone □ Nat. Ret.			* Ang. Gradone - SX □ Nat. Ret.		* Ang. Gradone - DX □ Nat. Ret.		
	30x120 12"x48"	30x90 12"x35 1/2"	30x60 12"x24"	30x120 12"x48"	30x90 12"x35 1/2"	30x60 12"x24"	30x120 12"x48"	30x90 12"x35 1/2"	30x60 12"x24"
SPESSORE - THICKNESS - EPAISSEUR - STÄRKE	20 mm	20 mm	20 mm	20 mm	20 mm	20 mm	20 mm	20 mm	20 mm

		* Gradone grip □ Nat. Ret.			* Ang. Gradone grip - SX □ Nat. Ret.		* Ang. Gradone grip - DX □ Nat. Ret.		
	30x120 12"x48"	30x90 12"x35 1/2"	30x60 12"x24"	30x120 12"x48"	30x90 12"x35 1/2"	30x60 12"x24"	30x120 12"x48"	30x90 12"x35 1/2"	30x60 12"x24"
SPESSORE - THICKNESS - EPAISSEUR - STÄRKE	20 mm	20 mm	20 mm	20 mm	20 mm	20 mm	20 mm	20 mm	20 mm

		* Elemento a L □ Nat. Ret.			* Elemento a L SX □ Nat. Ret.		* Elemento a L DX □ Nat. Ret.		
	33x120x4h 13"x48"x1 1/2"h	33x90x4h 13"x35 1/2"x1 1/2"h	33x60x4h 13"x24"x1 1/2"h	33x120x4h 13"x48"x1 1/2"h	33x90x4h 13"x35 1/2"x1 1/2"h	33x60x4h 13"x24"x1 1/2"h	33x120x4h 13"x48"x1 1/2"h	33x90x4h 13"x35 1/2"x1 1/2"h	33x60x4h 13"x24"x1 1/2"h
SPESSORE - THICKNESS - EPAISSEUR - STÄRKE	20 mm	20 mm	20 mm	20 mm	20 mm	20 mm	20 mm	20 mm	20 mm

	*** piedino regolabile 25-30	*** piedino regolabile 30-37	*** piedino regolabile 37-50	*** piedino regolabile 50-75	*** piedino regolabile 75-125	*** piedino regolabile 125-225	*** prolunga piedini h 100 mm	chiave di regolazione
	600101	600102	600103	600104	600105	600106	600107	600108
	20	20	20	20	20	20	20	1

* A disposizione solo su richiesta. Tempi di consegna 30 gg.
Available upon request only. Delivery terms: 30 days.
Disponible seulement sur requête. Délais de livraison: 30 jours.
Verfügbar auf Anfrage. Lieferzeit: 30 Tage.

*** Vendita a scatola completa.
Full box sale.
Vente à la boîte complète.
Volle Kartons.

□ Naturale e rettificato.
Natural and rectified.
Naturel et rectifié.
Natur Oberfläche und kalibriert.

▮ Costa retta.
Straight edge.
Bord droit.
Gerade Kante.

⤵ Costa toro.
Bullnose edge.
Bord boudin.
Abgerundete Kante.

Per le condizioni generali di vendita e le caratteristiche tecniche consultare www.tagina.it.
General terms and Sales conditions and Technical features are available on our website www.tagina.it.
Les Conditions général de vente et les Caractéristiques techniques sont disponibles sur le site web www.tagina.it.
Allgemeine Verkaufsbedingungen und technische Eigenschaften sind auf unsere Website verfügbar: www.tagina.it

Pezzi speciali per piscina

Special pieces for swimming pool - Pièces spéciales pour piscine - Formteile für Schwimmbad

		* Gradone bordo piscina □ Nat. Ret.			* Ang. Gradone bordo piscina - SX □ Nat. Ret.		* Ang. Gradone bordo piscina - DX □ Nat. Ret.		
	30x120 12"x48"	30x90 12"x35 1/2"	30x60 12"x24"	30x120 12"x48"	30x90 12"x35 1/2"	30x60 12"x24"	30x120 12"x48"	30x90 12"x35 1/2"	30x60 12"x24"
SPESSORE - THICKNESS - EPAISSEUR - STÄRKE	20 mm	20 mm	20 mm	20 mm	20 mm	20 mm	20 mm	20 mm	20 mm

		* Gradone grip bordo piscina □ Nat. Ret.			* Ang. Gradone grip bordo piscina - SX □ Nat. Ret.		* Ang. Gradone grip bordo piscina - DX □ Nat. Ret.		
	30x120 12"x48"	30x90 12"x35 1/2"	30x60 12"x24"	30x120 12"x48"	30x90 12"x35 1/2"	30x60 12"x24"	30x120 12"x48"	30x90 12"x35 1/2"	30x60 12"x24"
SPESSORE - THICKNESS - EPAISSEUR - STÄRKE	20 mm	20 mm	20 mm	20 mm	20 mm	20 mm	20 mm	20 mm	20 mm

		* Gradone svasato bordo piscina □ Nat. Ret.			* Ang. Gradone svasato bordo piscina - SX □ Nat. Ret.		* Ang. Gradone svasato bordo piscina - DX □ Nat. Ret.		
	30x120 12"x48"	30x90 12"x35 1/2"	30x60 12"x24"	30x120 12"x48"	30x90 12"x35 1/2"	30x60 12"x24"	30x120 12"x48"	30x90 12"x35 1/2"	30x60 12"x24"
SPESSORE - THICKNESS - EPAISSEUR - STÄRKE	20 mm	20 mm	20 mm	20 mm	20 mm	20 mm	20 mm	20 mm	20 mm

	* Griglia □ Nat. Ret. 20x60 8"x24"	* Griglia SX □ Nat. Ret. 20x60 8"x24"	* Griglia DX □ Nat. Ret. 20x60 8"x24"
SPESSORE - THICKNESS - EPAISSEUR - STÄRKE	20 mm	20 mm	20 mm

Per maggiori informazioni su imballi e codici articolo potete consultare il nostro BOOK (anche da sito internet, nell'area "download").
For more information on packaging and item codes, please refer to our BOOK (also available for download on our website, in the "download" area).
Pour plus d'informations sur les emballages et les codes articles, vous pouvez consulter notre BOOK (également depuis le site, dans la zone "téléchargement").
Weitere Informationen zu Verpackungen und Artikelcodes finden Sie in unserem BOOK (auch auf der Website, im Bereich "Download").

Tagina S.p.A. si riserva di modificare, senza alcun preavviso, il packaging dei prodotti, le grafiche, i colori e i decori riportati nelle immagini che sono pertanto da ritenersi indicative.
Tagina S.p.A. reserves the right to change the product packaging, the patterns, colours and decorations shown in the pictures without any prior notice. These aspects, therefore should be considered for illustrative purposes only.
Tagina S.p.A. se réserve le droit de modifier, sans préavis, l'emballage des produits, les graphismes, les couleurs et les décors représentés dans les images, fournies à titre indicatif.
Die Tagina S.p.A. behält sich vor, die Verpackung der Produkte, die in den Abbildungen gezeigten Grafiken, Farben und Dekors sowie ohne vorherige Ankündigung zu ändern.

PEZZI SPECIALI PER ESTERNO

Special pieces for outdoor
Pièces spéciales pour extérieur
Formteile für Aussenbereich

Elemento a L



Gradone grip

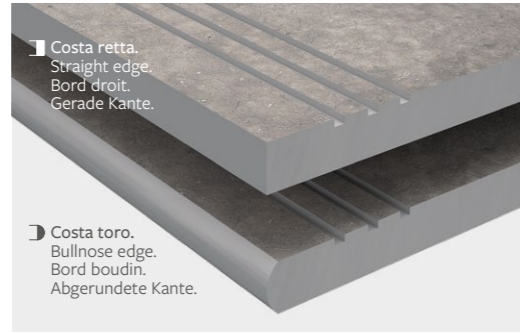

Gradone

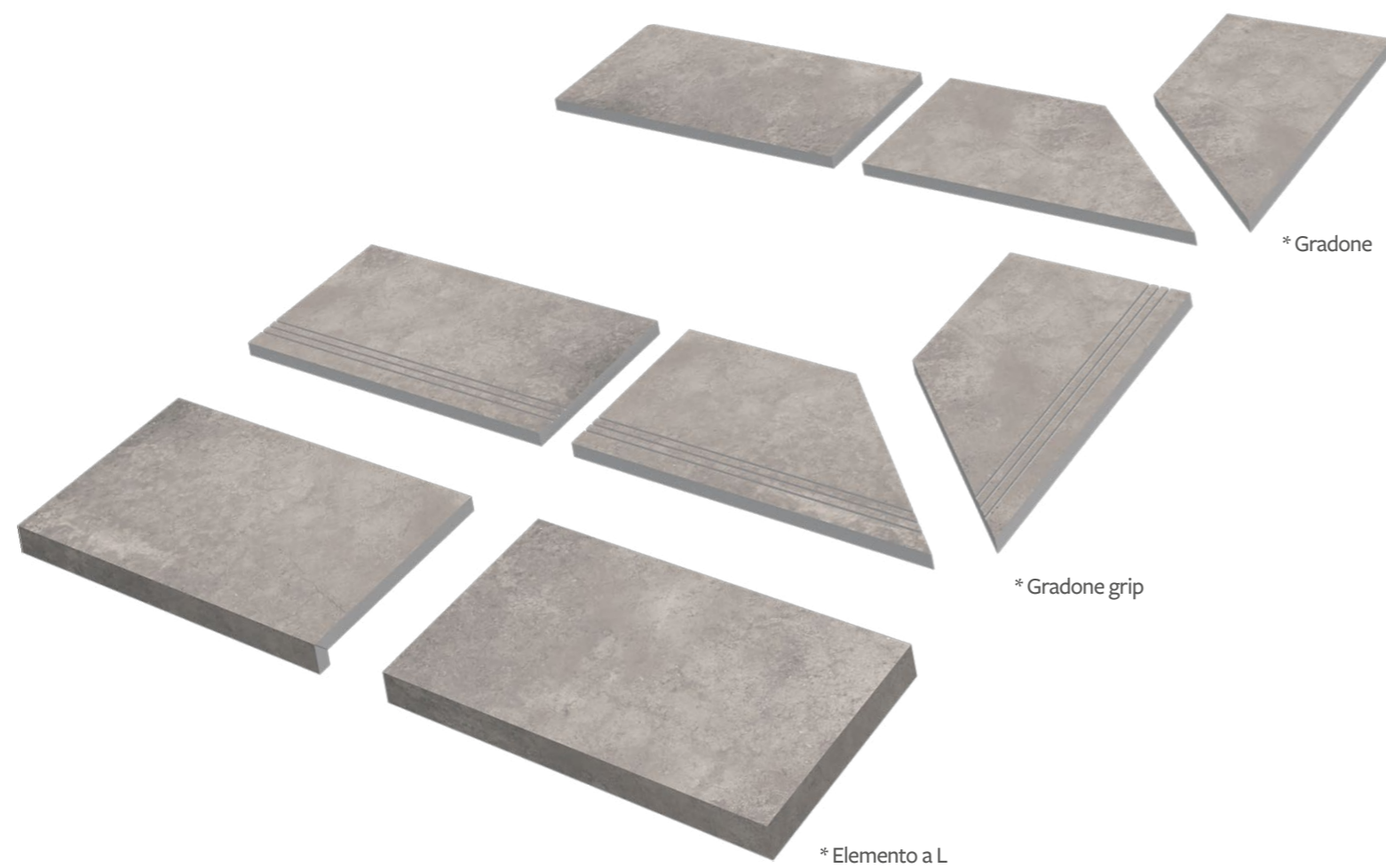
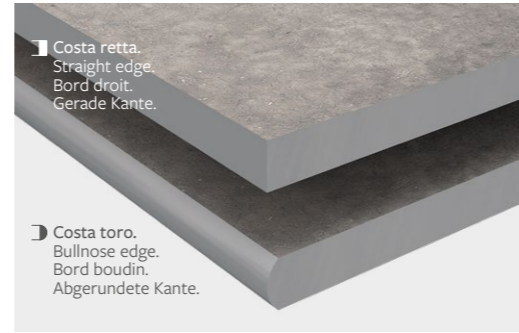

PEZZI SPECIALI PER PISCINA

Special pieces for swimming pool
Pièces spéciales pour piscine
Formteile für Schwimmbad

Gradone svasato bordo piscina

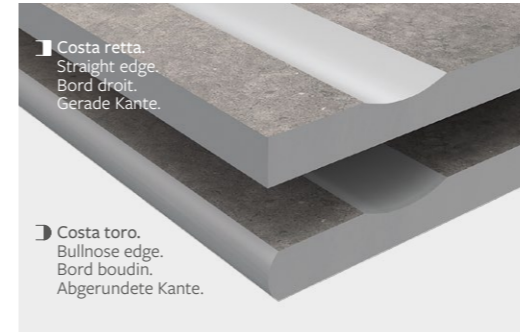

Gradone grip bordo piscina

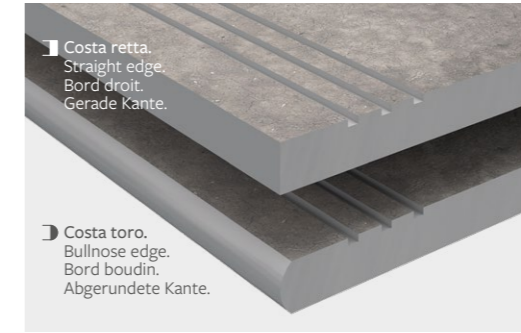

Gradone bordo piscina

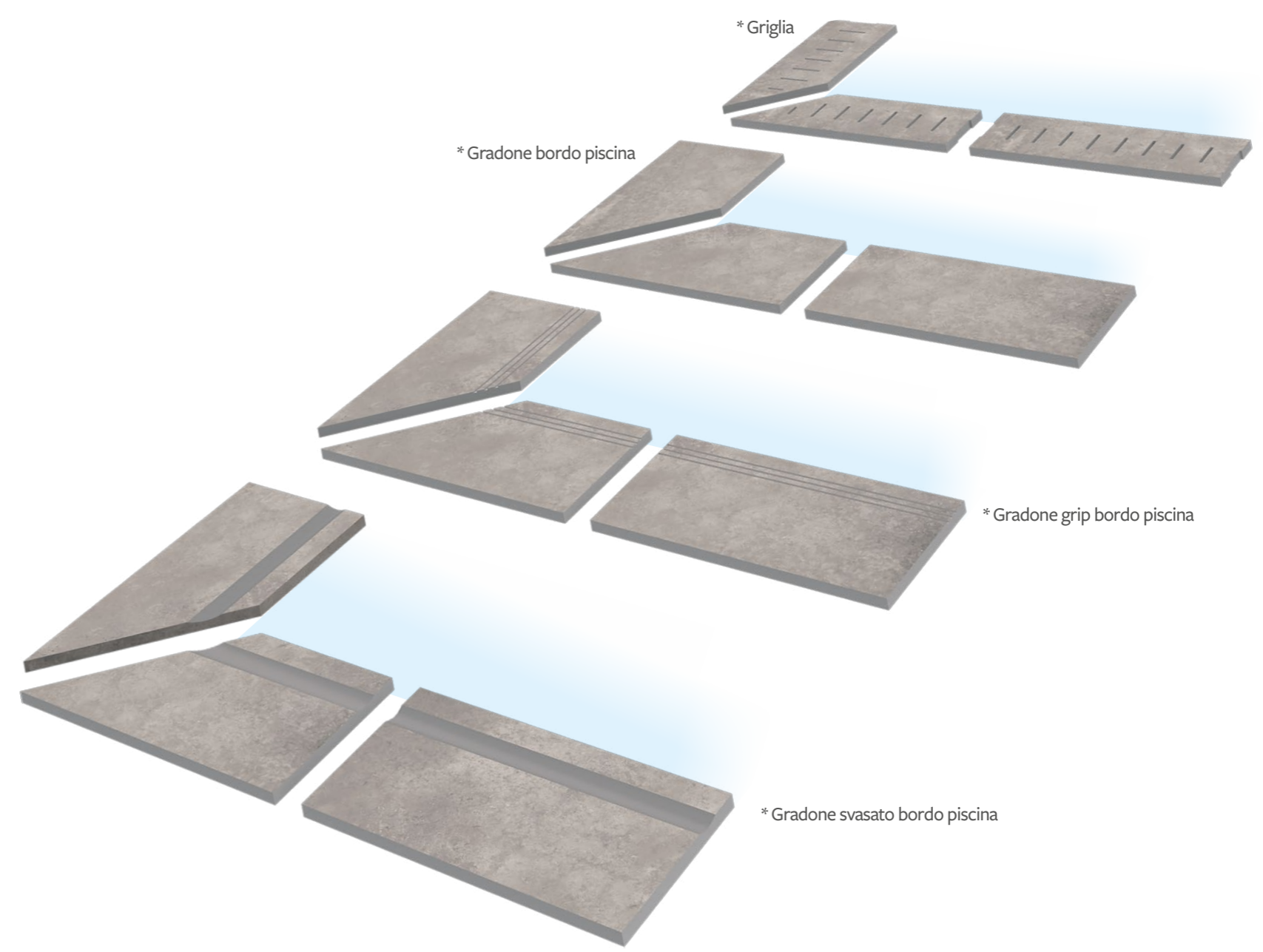
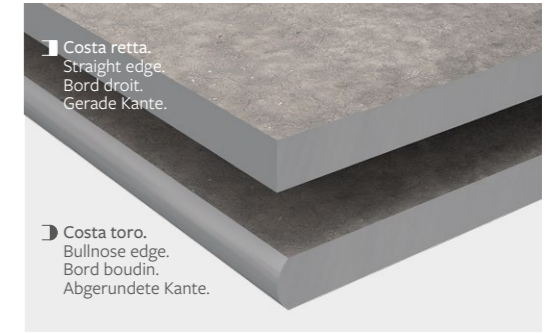

* I tempi di consegna di tutti i pezzi speciali mostrati in queste pagine sono di 30 giorni dalla data dell'ordine.
Delivery time for all the special pieces shown on these pages are generally 30 days from order date.
La livraison de toutes les pièces spéciales présentés dans les pages du catalogue sont disponible 30 jours à compter de la date de commande.
Der Liefertermin fuer die Spezialteile, die in dieser Seite aufgefuehrt sind, belaeuft sich auf 30 Tage nach Auftragseingang.

Pezzi speciali: massima cura in ogni dettaglio

Special pieces: the utmost care in every detail.
Pièces spéciales : le soin maximal dans le moindre détail.
Formteile: maximale Sorgfalt in jedem Detail.

IL FASCINO TRADIZIONALE DEL GRADINO A "C"

The traditional appeal of the "C" step.
Le charme traditionnel de l'étape « C »
Der traditionelle Charme der „C“-Stufe.

Tagina pone attenzione a tutte le componenti architettoniche degli spazi da abitare. Ai gradini sono dedicati pezzi speciali appositamente progettati per ottenere il massimo risultato estetico. La gamma comprende un elemento "gradino a C" al quale si possono affiancare gli elementi che completano gli angoli sinistro e

Tagina takes great care over all the architectural elements of the living spaces. Special pieces are used for the stairs, specially designed to obtain the maximum aesthetic result. The range includes a "C-step" element which can be combined with the elements that complete the left and right corners.

Tagina prête attention à toutes les composantes architecturales des espaces de vie. Les étapes sont dédiées à des pièces spéciales spécialement conçues pour obtenir un résultat esthétique maximal. La gamme comprend un élément « marche en C » auquel vous pouvez assortir les autres éléments qui complètent les angles gauche et droit.

Tagina achtet auf alle architektonischen Komponenten der Wohnräume. Den Stufen sind Spezialteile gewidmet, um ein optimales ästhetisches Ergebnis zu erzielen. Das Sortiment umfasst ein „C-Stufen-Element“, das durch Elemente zur Vervollständigung der linken und rechten Ecke ergänzt werden kann.

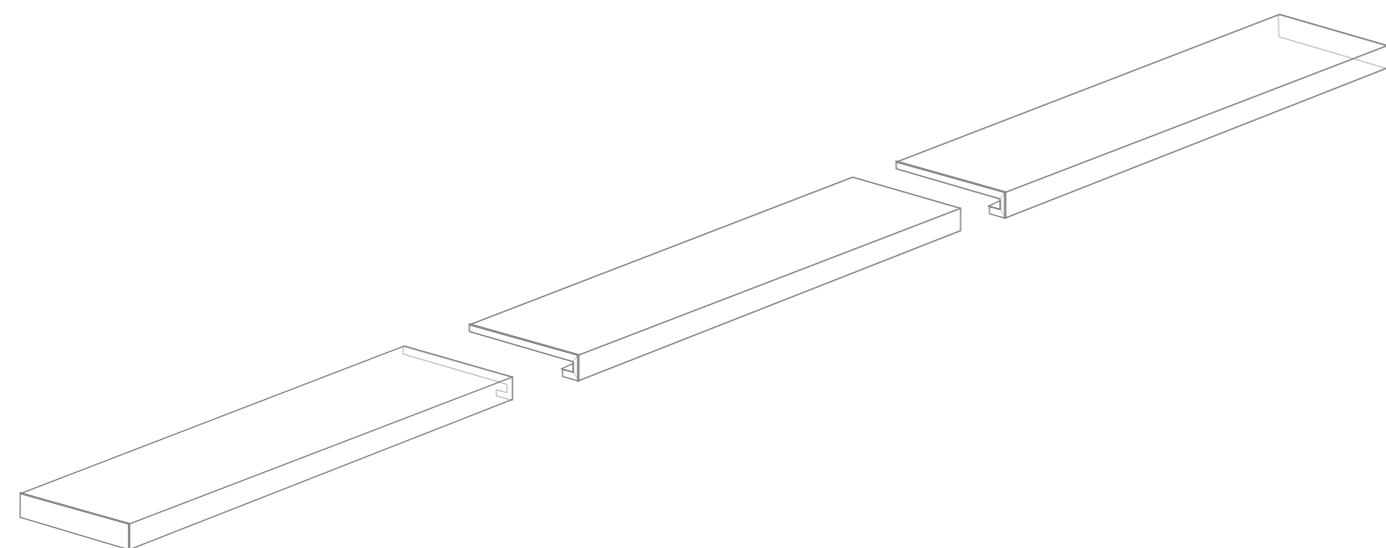

IL "COPRISPIGOLO TRIANGOLARE"

The "triangular edge cover".
Le « cache-arête triangulaire »
„Dreieckiger Kantenschutz“

La gamma della collezione "Concreta" include l'elemento "CoprispigoLO triangolare" e "Angolo CoprispigoLO triangolare". Consente di risolvere con eleganza e semplicità problematiche legate alla congiunzione delle lastre in presenza di spigoli e angoli. È possibile adottare questa soluzione sia a rivestimento che a pavimento ad esempio per realizzare gradini o per comporre volumi geometrici.

The range of the "Concreta" collection includes the "Triangular edge cover and Triangular corner edge cover" element. It allows problems encountered to be solved elegantly and simply when joining slabs where there are edges and corners. It is possible to adopt this solution both for cladding and flooring, e.g. to create steps or compose geometric volumes.

La gamme de la collection « Concreta » comprend l'élément «Cache-arête Triangulaire et Angle Cache-arête Triangulaire». Il permet de résoudre avec élégance et simplicité les problèmes liés à l'assemblage des dalles en présence de bords et de coins. Il est possible d'adopter cette solution aussi bien pour le revêtement que pour le dallage, par exemple pour créer des marches ou composer des volumes géométriques.

Das Sortiment der Kollektion „Concreta“ umfasst das Element „Dreieckige Eckabdeckung und Winkel Dreieckige Eckabdeckung“. Es ermöglicht, mit Eleganz und Einfachheit alle Probleme zu lösen, die mit dem Zusammenfügen der Platten bei Vorhandensein von Kanten und Ecken zusammenhängen. Diese Lösung kann sowohl für Verkleidungen als auch für Böden verwendet werden, beispielsweise um Stufen oder geometrische Volumen zu schaffen.

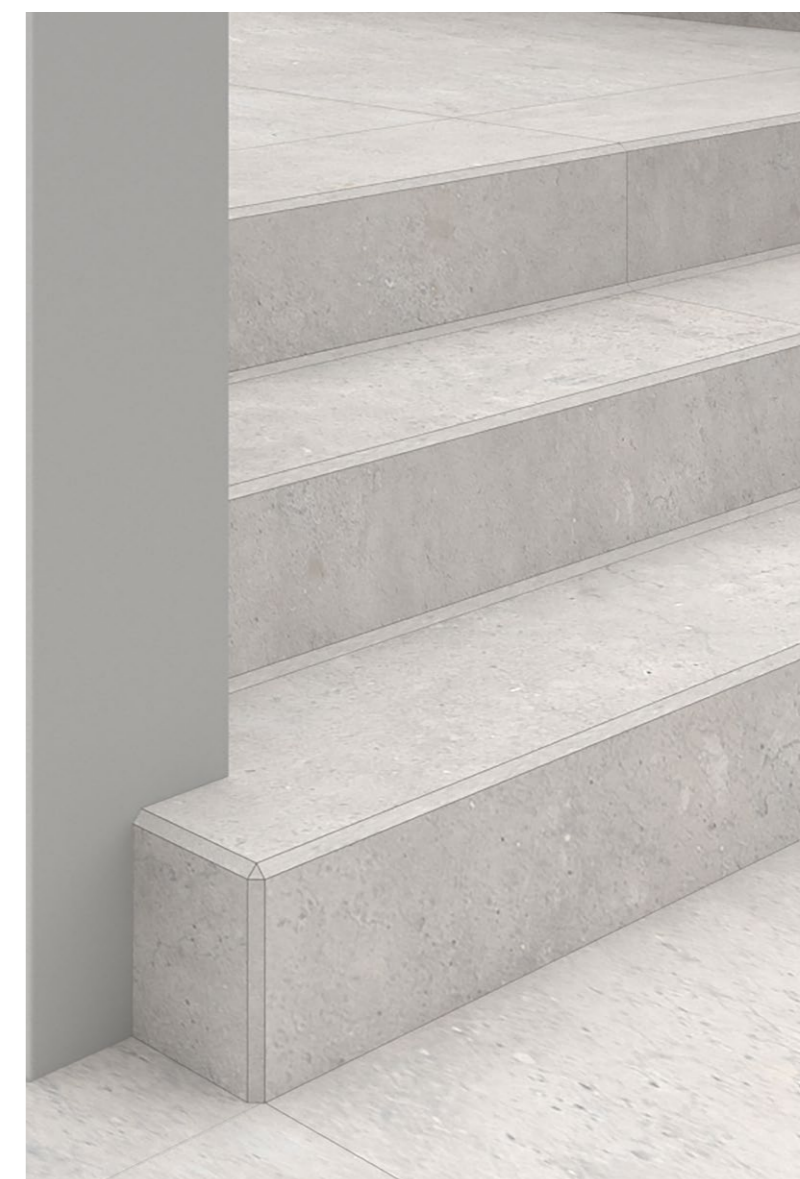



Tagina S.p.A.
Via Emilia Ponente, 925
48014 Castel Bolognese (RA) - Italy
Tel. +39 0545 197 7303

tagina.it -  DAFIN GROUP

