

2020



Catalogo Generale
Master Catalogue

Panaria
ceramica

La bellezza di sentirsi a casa

The beauty of feeling at home

Indice

General index

I nostri valori	6	Dati tecnici	368
Our values		Technical data	
Le nostre eccellenze	12	Caratteristiche tecniche	370
Our excellences		<i>Technical features</i>	
Zero.3	14	Caratteristiche di sicurezza e termiche	378
20 mm	16	<i>Safety and thermal features</i>	
Soluzioni Decorative	18	Informazioni per la posa	380
Protect	20	<i>Laying information</i>	
Linea Fiordo	22	Resistenza allo scivolamento	383
		<i>Slip resistance</i>	
Il nostro Gruppo	24	Tabella calibri	384
Our Group		<i>Size table</i>	
Le collezioni	32	Pulizia	386
Collections		<i>Cleaning</i>	
Assi d'Alpe	276	Panaria e l'ambiente	393
Bioarch	40	<i>Panaria and the environment</i>	
Chic Wood	284	Certificazioni di qualità	405
Context	150	<i>Quality certifications</i>	
Cross Wood	290	Indice alfabetico dei prodotti	408
Discover	52	<i>List of products in alphabetical order</i>	
Doghe	300	Condizioni generali di vendita	412
Eternity	242	<i>General conditions of sale</i>	
Even	344		
Experience	164		
Frame	64		
Genesis	172		
Glance	178		
Horizon	74		
In-Wood	306		
Memory Mood	188		
Motion	202		
Must	358		
North Cape	312		
Nuance	318		
Opificio 22/a	210		
Petra Solis	86		
Pierre des Rêves	96		
Pietre di Fanes	110		
Prime Stone	116		
Rock Style	130		
Tracks	138		
Trilogy	258		
Urbanature	224		
Wood Relive	332		

Indice per effetto

Index by effect

Effetto Pietra

Stone look

Bioarch		40
Discover	[P]	52
Frame	●	64
Horizon	[P]	74
Petra Solis		86
Pierre des Rêves	[P]	96
Pietre di Fanes		110
Prime Stone	[P]	116
Rock Style	●	130
Tracks	●	138

Effetto Cemento

Concrete look

Context	[P]	150
Experience		164
Genesis	●	172
Glance		178
Memory Mood		188
Motion	●	202
Opificio 22/a	[P]	210
Urbanature	[P]	224

Effetto Marmo

Marble look

Eternity	[P]	242
Trilogy	[P]	258

Effetto Legno

Wood look

Assi d'Alpe		276
Chic Wood	[P]	284
Cross Wood		290
Doghe		300
In-Wood	●	306
North Cape	[P]	312
Nuance	[P]	318
Wood Relive	●	332

Effetto Cromatico

Chromatic look

Even		344
Must	[P]	358

● = Fiordo

[P] = P R () T E C T
ANTIBATTERICO · ANTIMICROBIAL

Indice per tecnologia

Index by categories

Zero.3

Laminated porcelain stoneware

Context	[P]	150
Doghe		300
Eternity	[P]	242
Experience		164
Must	[P]	358
Prime Stone	[P]	116
Trilogy	[P]	258
Urbanature		224

Gres Porcellanato

Porcelain stoneware

Assi d'Alpe		276
Bioarch		40
Chic Wood	[P]	284
Context	[P]	150
Cross Wood		290
Discover	[P]	52
Eternity	[P]	242
Frame	●	64
Genesis	●	172
Glance		178
Horizon	[P]	74
In-Wood	●	306
Memory Mood		188
Motion	●	202
North Cape	[P]	312
Nuance	[P]	318
Opificio 22/a	[P]	210
Petra Solis		86
Pierre des Rêves	[P]	96
Pietre di Fanes		110
Prime Stone	[P]	116
Rock Style	●	130
Tracks	●	138
Trilogy	[P]	258
Urbanature	[P]	224
Wood Relive	●	332

20 mm

High thickness

Bioarch		40
Context		150
Cross Wood		290
Discover		52
Frame	●	64
Horizon		74
Memory Mood		188
Nuance		318
Opificio 22/a		210
Petra Solis		86
Pierre des Rêves		96
Prime Stone		116
Tracks	●	138
Urbanature		224

Monoporosa

Single fired wall tiles

Even		344
Prime Stone		116
Trilogy		258

Indice per formato

Index by size

100x300

Experience	164
Doghe	300
Must	358
Prime Stone	116
Trilogy	258
Urbanature	224

120x260

Context	150
Eternity	242

100x250

Prime Stone	116
-------------	-----

120x120

Context	150
Eternity	242

100x100

Experience	164
Must	358
Prime Stone	116
Trilogy	258
Urbanature	224

50x100

Experience	164
Prime Stone	116
Trilogy	258
Urbanature	224

35x100

Even	344
Trilogy	258

20x100

Doghe	300
-------	-----

30x180

North Cape	312
Nuance	318

20x180

North Cape	312
Nuance	318

20x150

Doghe	300
-------	-----

20x200

Doghe	300
-------	-----

60x120

Context	150
Discover	52
Eternity	242
Horizon	74
Pierre des Rêves	96
Trilogy	258

40x120

Nuance	318
--------	-----

30x120

Nuance	318
Cross Wood	290

20x120

Chic Wood	284
Cross Wood	290
In-Wood	306
Nuance	318
Wood Relive	332

20x90,5

Assi d'Alpe	276
North Cape	312

90x90

Context	150
Glance	178
Horizon	74
Memory Mood	188
Opificio 22/a	210
Pierre des Rêves	96
Prime Stone	116
Trilogy	258
Urbanature	224

45x90

Frame	64
Glance	178
Prime Stone	116
Urbanature	224

22,5x90

Urbanature	224
------------	-----

60x60

Bioarch	40
Context	150
Discover	52
Eternity	242
Frame	64
Genesis	172
Glance	178
Horizon	74
Memory Mood	188
Motion	202
Opificio 22/a	210
Petra Solis	86
Pierre des Rêves	96
Prime Stone	116
Tracks	138
Trilogy	258
Urbanature	224

40x60

Petra Solis	86
-------------	----

30x60

Bioarch	40
Context	150
Discover	52
Eternity	242
Frame	64
Genesis	172
Glance	178
Horizon	74
Memory Mood	188
Motion	202
Opificio 22/a	210
Pierre des Rêves	96
Prime Stone	116
Tracks	138
Trilogy	258
Urbanature	224

30x56,5

Rock Style	130
------------	-----

20x60

Discover	52
Prime Stone	116

15x60

Bioarch	40
Discover	52
Prime Stone	116

50x50

Experience	164
------------	-----

45x45

Urbanature	224
------------	-----

20x40

Bioarch	40
Petra Solis	86
Pierre des Rêves	96
Pietre di Fanes	110

40x40

Petra Solis	86
-------------	----

20x30,2

Pierre des Rêves	96
------------------	----

20x30,5

Bioarch	40
Pietre di Fanes	110

20x20

Bioarch	40
Memory Mood	118
Opificio 22/a	210
Petra Solis	86
Pierre des Rêves	96
Pietre di Fanes	110

Ti diamo il benvenuto nel mondo Panaria

Welcome to the world of Panaria

Ti diamo il benvenuto nel mondo Panaria, dove da sempre sappiamo scegliere il meglio per la casa. “La bellezza di sentirsi a casa” per noi significa il piacere di vivere in spazi armonici e versatili, in cui le nostre collezioni soddisfano personalità molteplici e desideri differenti adattandosi ad usi e costumi in divenire. Oggi, con il nostro nuovo logo vogliamo sottolineare un’immagine che si evolve, per essere sempre più vicini a tante storie di casa, di progetti e di persone, con la consapevolezza della nostra tradizione che sostiene con rinnovata energia la visione di un futuro migliore.

Welcome to the world of Panaria, where we have always known how to choose the best for the home. To us, “the beauty of feeling at home” means the pleasure of living in harmonious and versatile spaces, in which our collections satisfy multiple personalities and different desires, adapting to changing habits and customs. Today, with our new logo we want to highlight an image that is evolving to be increasingly close to many home, project and people stories, with the awareness of our tradition that supports the vision of a better future with renewed energy.

Wir heißen Sie in der Welt von Panaria willkommen, wo wir es verstehen, stets das Beste für die eigenen vier Wände auszuwählen. „Die Schönheit, sich wie zu Hause zu fühlen“ bedeutet für uns das Vergnügen, in harmonischen und vielseitigen Räumen zu leben, in denen unsere Kollektionen vielfältigen Persönlichkeiten und unterschiedlichen Wünschen gerecht werden und sich an wandelnde Nutzungen und Gebräuche anpassen. Heute, mit unserem neuen Logo, möchten wir ein Image unterstreichen, das sich weiterentwickelt, um an unzähligen Geschichten von Zuhause, Projekten und Menschen immer näher zu sein, mit dem Bewusstsein für unsere Tradition, die mit erneuerter Energie die Vision einer besseren Zukunft unterstützt.

Nous vous souhaitons la bienvenue dans le monde Panaria, où nous choisissons depuis toujours ce qu’il y a de meilleur pour la maison. « La beauté de se sentir chez soi » signifie pour nous le plaisir de vivre dans des espaces harmonieux et polyvalents, dans lesquels nos collections satisfont de multiples personnalités et différents désirs en s’adaptant à des usages et coutumes en pleine évolution. Actuellement, avec notre nouveau logo nous voulons insister sur une image qui évolue, afin d’être toujours plus proche de tant d’histoires de maison, de projets et de personnes, en ayant conscience que notre tradition supporte avec une énergie renouvelée la vision d’un avenir meilleur.





La tua casa, una storia da raccontare

Your home, a story to tell

Tutti desideriamo uno spazio che ci rappresenti e assomigli, specchio di ciò che siamo e di come vogliamo vivere, teatro e palcoscenico di esperienze quotidiane e di emozioni da condividere. Abitare al meglio, realizzare le nostre ambizioni, godere in pieno della bellezza di sentirsi a casa: con Panaria diventa possibile, grazie a un'accurata selezione di superfici e corredi di completamento in grado di soddisfare ogni esigenza dell'abitare contemporaneo. Panaria dal 1974 ha saputo rinnovare nel tempo i valori di una grande cultura ceramica, uniti alla passione e ad alla capacità spiccatamente made in Italy di proporre soluzioni di eccellenza estetica, qualità e affidabilità, per creare ogni giorno un nuovo modo di vivere la casa.

We all want a home that reflects and resembles us, a mirror of who we are and how we want to live, a theatre and a stage for daily experiences and emotions to be shared. Living in the best possible way, realizing our ambitions, fully enjoying the beauty of feeling at home: with Panaria it is possible, thanks to the careful selection of surfaces and fittings that meet contemporary needs. Throughout the years since 1974, Panaria has continuously evolved the traditional skills of a great ceramic culture, combining passion and that special Made in Italy flair to produce products of aesthetic excellence, outstanding quality and reliability. And now even more, with a new image and a lot of energy to create new ways of enjoying your home every day.

Wir alle wünschen uns einen Raum, der uns repräsentiert und uns ähnlich ist - ein Spiegel dessen, was wir sind und wie wir leben wollen, Schauplatz und Bühne von alltäglichen Erfahrungen und gemeinsamen Emotionen. Optimal wohnen, unsere Ziele verwirklichen und voll und ganz das schöne Gefühl genießen, sich zu Hause zu fühlen: Panaria macht das durch eine sorgfältige Auswahl von Oberflächen und Einrichtungen möglich, die allen Ansprüchen an das moderne Wohnen gerecht werden. Panaria erneuert seit 1974 beständig die Werte einer großen Keramikkultur zusammen mit der Leidenschaft und der ausgeprägten Made in Italy-Fähigkeit, Lösungen mit hervorragender Ästhetik, Qualität und Zuverlässigkeit bereitzustellen, um jeden Tag ein neues Wohngefühl zu erzeugen.

Nous désirons tous un espace qui nous représente et nous ressemble, un miroir de qui nous sommes et de comment nous voulons vivre, un théâtre et une scène pour partager nos expériences et nos émotions quotidiennes. Habiter de façon idéale, réaliser ses ambitions, profiter de la joie de se sentir chez soi: avec Panaria c'est possible, grâce à un choix rigoureux de surfaces et d'équipements capables de satisfaire tous les besoins de l'habitat contemporain. Depuis 1974, Panaria a su renouveler au fil du temps les valeurs d'une grande culture de la céramique, alliées à la passion et à la capacité du Made in Italy d'offrir des solutions d'excellence esthétique, de qualité et de fiabilité, pour créer chaque jour une nouvelle façon de vivre la maison.



La qualità, un progetto da condividere

La qualità, un progetto da condividere

Il nostro gres porcellanato è quanto di più performante si possa trovare oggi sul mercato, grazie a una continua innovazione, alla scelta di materie prime ricercate e selezionate e ad un importante know-how aziendale. Il continuo aggiornamento e perfezionamento della gamma prodotti aggiunge eccellenze tecnologiche più specifiche, che compongono un'offerta ampia e variegata capace di dare risposte puntuali e specializzate alla progettazione di spazi indoor e outdoor. I nostri prodotti soddisfano personalità molteplici e desideri differenti con la vocazione di garantire sempre la massima qualità tecnica ed estetica, per accompagnare tante storie diverse in cui sentirsi protagonisti.

Our porcelain stoneware offers the highest performance on today's market thanks to continuous innovation, to sophisticated and carefully selected raw materials and to the company's considerable expertise. The continuous upgrading and improvement of the product range adds more specific technological excellence, forming a wide-ranging and varied offer that can provide precise and specialised responses to the design of indoor and outdoor spaces. Our products satisfy many different personalities and desires by always guaranteeing the highest technical and aesthetic quality, accompanying many different stories that you can feel a part of.

Unser Feinsteinzeug ist eines der leistungsstärksten Materialien, die heute auf dem Markt zu finden sind. Dafür sorgt eine kontinuierliche Innovation, die Auswahl von edlen und erlesenen Rohstoffen und ein großes firmeneigenes Know-how. Die kontinuierliche Aktualisierung und Perfektionierung der Produktpalette fügt eine spezifischere technologische Exzellenz für ein breites und facettenreiches Angebot hinzu, das in der Lage ist, präzise und spezialisierte Lösungen für die Planung von Indoor- und Outdoor-Bereichen zu liefern. Unsere Produkte stellen vielfältige Persönlichkeiten und unterschiedliche Wünsche mit der Berufung zufrieden, stets maximale technische und ästhetische Qualität zu garantieren, um viele unterschiedliche Geschichten zu begleiten, in denen man sich als Protagonisten fühlen kann.

Notre grès cérame est actuellement le plus performant du marché, grâce à une innovation continue, au choix de matières premières recherchées et sélectionnées et à l'immense savoir-faire de l'entreprise. A l'actualisation et au perfectionnement incessants de notre gamme de produits s'ajoutent des technologies de pointe plus spécifiques, qui composent une offre vaste et variée, en mesure de répondre de façon précise et spécialisée à tous les projets d'espaces intérieurs et extérieurs. Nos produits satisfont des personnalités multiples et des désirs différents, avec la vocation de garantir toujours le maximum de qualité technique et esthétique, pour accompagner des histoires nombreuses et toutes différentes dont vous serez les acteurs.



Le nostre eccellenze

Our excellences

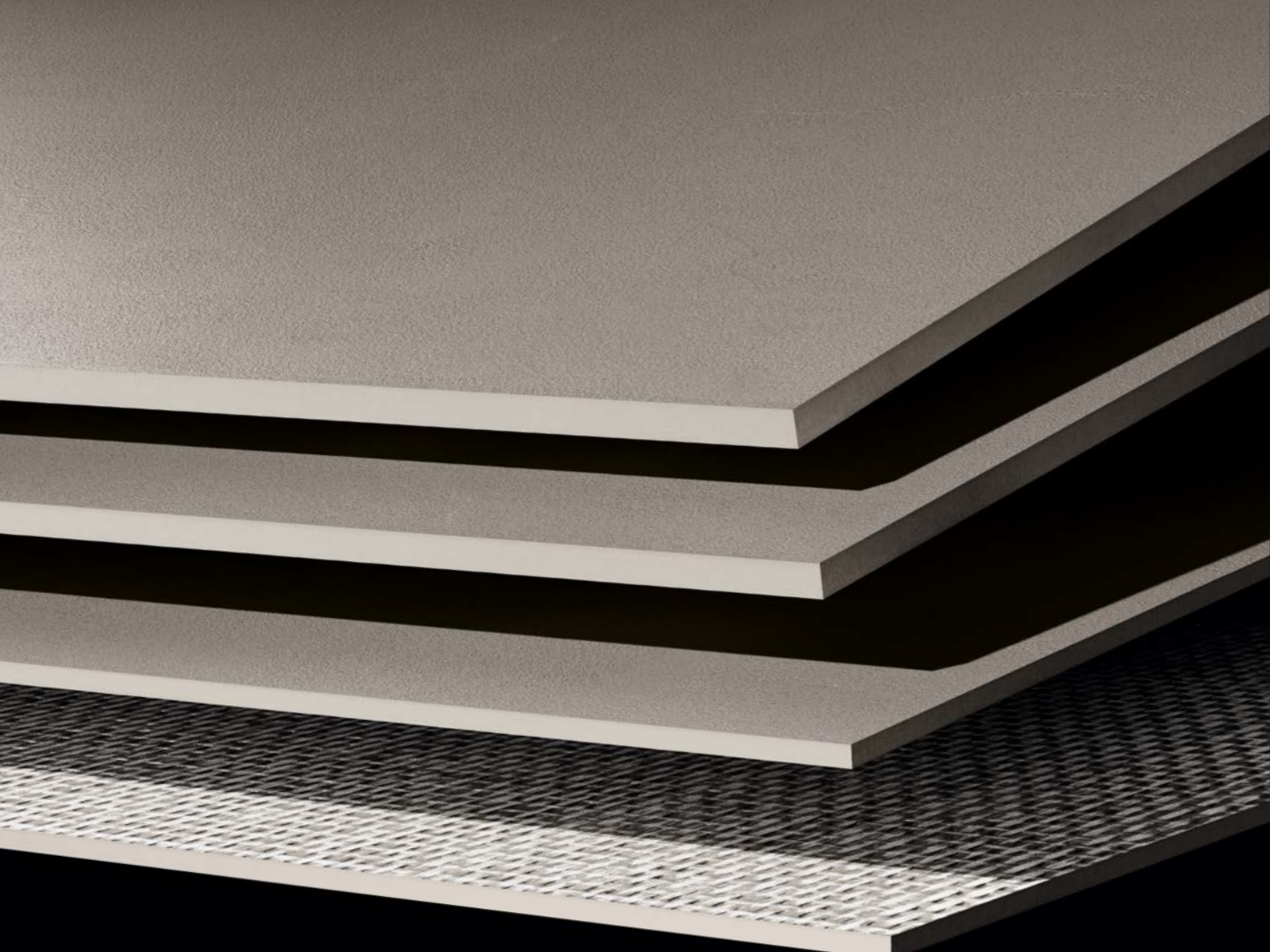

**FORMATI
SIZES**

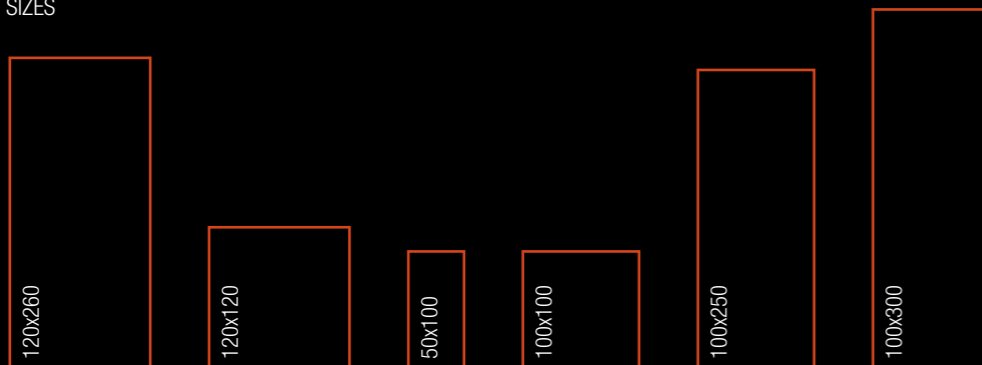

ZERO.3

± 6 mm

SOTTILE E RESISTENTE
THIN AND RESISTANT

ZERO.3 PLUS

± 3,5 mm - 5,5 mm

ULTRASOTTILE E ULTRARESISTENTE. CON RINFORZO IN FIBRA DI VETRO
ULTRA-THIN AND ULTRA-RESISTANT. WITH FIBREGLASS MESH REINFORCEMENT

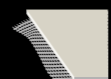

Zero.3

**Lastre ceramiche sottili
di qualità superiore**

**Superior quality
thin porcelain slabs**

Gres porcellanato laminato in grande formato: un materiale leggero, versatile e resistente per nuove prospettive progettuali nel mondo dell'architettura e dell'abitare.

Large-sized laminated porcelain stoneware: a light, resistant and versatile product for new design perspectives in the world of architecture and housing.

Großformatiges laminiertes Feinsteinzeug: ein leichtes, vielseitiges und widerstandsfähiges Material für Design-Perspektiven in der Welt der Architektur und des Wohnens.

Grès cérame laminé en grand format : un matériau léger, polyvalent et résistant pour de nouvelles perspectives conceptuelles dans le monde de l'architecture et de l'habitat.

MASSIMI STANDARD QUALITATIVI E PRESTAZIONALI
Grazie all'utilizzo di materie prime pregiate.

LASTRE SUPERCOMPATTE ED ELASTICHE
Grazie a un processo di pressatura unico.

ECCELLENTE RESA ESTETICA DEI MATERIALI
Grazie a tecniche esclusive di lavorazione delle superfici.

STRAORDINARIA EXTRA-RESISTENZA
Grazie al rinforzo in fibra di vetro.

ALTA SOSTENIBILITÀ AMBIENTALE
Meno materie prime utilizzate, minor consumo di acqua ed energia, minori emissioni di CO₂.

HIGHEST STANDARDS IN QUALITY AND PERFORMANCE
Thanks to the use of the best raw materials.

HIGHLY COMPACT AND ELASTIC SLABS
Thanks to a unique pressing process.

EXCELLENT AESTHETIC LOOK OF THE PRODUCTS
Thanks to exclusive surface processing technologies.

EXTRAORDINARY ADDED RESISTANCE
Thanks to the reinforcing fibreglass mesh.

HIGHLY ECO-FRIENDLY
Less raw materials used, lower water and energy consumption and lower CO₂ emissions.

HÖCHSTE QUALITÄTS- UND LEISTUNGSSTANDARDS
Dank der Verwendung von hochwertigen Rohstoffen.

SUPERKOMPATTE UND ELASTISCHE PLATTEN
Dank eines einzigartigen Pressvorgangs.

AUSGEZEICHNETE ÄSTHETIK DER MATERIALIEN
Dank der exklusiven Bearbeitungstechniken der Oberflächen.

AUSSERGEWÖHNLICHE EXTRA-FESTIGKEIT
Dank der Verstärkung aus Glasfaser.

HOHE NACHHALTIGKEIT
Geringer Rohstoffverbrauch, weniger Wasser- und Energieverbrauch sowie weniger CO₂-Emissionen.

CRITERES TRÈS ÉLEVÉS DE QUALITÉ ET DE PERFORMANCE
Grâce à l'utilisation de matières premières précieuses.

DALLES SUPER COMPACTES ET ÉLASTIQUES
Grâce à un processus de pressage unique.

EXCELLENT RENDU ESTHÉTIQUE DES MATÉRIAUX
Grâce à des techniques exclusives de production des surfaces.

EXTRAORDINAIRE EXTRA-RESISTANCE
Grâce au renfort en fibre de verre.

HAUTE DURABILITÉ ENVIRONNEMENTALE
Moins de matières premières utilisées, moins de consommation d'eau et d'énergie, moins d'émissions de CO₂.



20 mm

Gres porcellanato 20 mm per outdoor

20 mm porcelain stoneware for outdoor

Il gres porcellanato 20 mm è il prodotto a massima prestazione tecnica ideale per ambienti esterni, senza rischio di rotture.

20 mm porcelain stoneware has the highest technical performance of any product and is perfect for outdoor spaces, with no risk of breakage.

RESISTENTE E FUNZIONALE

Elevata resistenza meccanica e allo scivolamento, altissima resistenza ai carichi di rottura.

FACILE E VERSATILE

Semplice da installare, rimuovere e riutilizzare; facile da pulire. Carrabile quando incollato su massetto.

UNA SUPERFICIE ETERNA

Materia e colori stabili nel tempo, eccezionale resistenza alle macchie.

ADATTO AD OGNI UTILIZZO IN ESTERNO

Ingelivo e ignifugo, resiste a qualsiasi agente atmosferico, agli sbalzi termici, agli acidi, alle muffe e al sale. Abbinabile ai prodotti da interno per un perfetto coordinamento estetico senza interruzioni.

ECOLOGICO

Creato nel rispetto e per la salvaguardia dell'ambiente.

RESISTANT AND FUNCTIONAL

Superior mechanical strength and slip resistance, highly resistant to heavy loads.

EASY AND VERSATILE

Simple to install, remove and reuse; easy to clean. Resistant to vehicular passage when applied to a screed with adhesives.

AN ETERNAL SURFACE

The product and its colors remain stable over time and are highly resistant to stains.

SUITABLE FOR ALL OUTDOOR USE

Resistant to frost, fire, atmospheric agents, thermal shock, acids, mold and salt. Can be combined with products for interior spaces seamlessly and without interruptions.

ECO-FRIENDLY

Manufactured in a way which respects and protects the environment.

Das Feinsteinzeug mit 20 mm ist das Produkt mit maximaler technischer Leistung, das sich ohne Bruchgefahr ideal für Außenbereiche eignet.

Le grès cérame de 20 mm est le produit offrant le maximum de performance technique, idéal pour les espaces extérieurs, sans risque de rupture.

BESTÄNDIG UND ZWECKMÄSSIG

Hohe Festigkeit und Rutschsicherheit, sehr hohe Beständigkeit gegen Bruchlasten.

EINFACH UND VIELSEITIG

Einfaches Verlegen, Entfernen und Wiederverwenden; leichte Reinigung. Befahrbar bei Verkleben auf Estrich.

EINE UNVERWÜSTLICHE OBERFLÄCHE

Material und Farben bleiben im Lauf der Zeit stabil, herausragende Fleckenbeständigkeit.

GEEIGNET FÜR ALLE ANWENDUNGEN IM FREIEN

Frost- und feuerbeständig, beständig gegen alle möglichen Witterungseinflüsse, gegen Temperaturschwankungen, Säuren, Schimmel und Salz. Kombinierbar mit Produkten für den Innenbereich für eine perfekte ästhetische Abstimmung ohne Unterbrechungen.

UMWELTFREUNDLICH

Herstellung unter Beachtung und zum Schutz der Umwelt.

RÉSISTANT ET FONCTIONNEL

Haute résistance mécanique et antidérapante, très haute résistance aux charges de rupture.

FACILE ET POLYVALENT

Facile à installer, enlever et réutiliser; facile à nettoyer. Carrossable s'il est collé sur une chape.

UNE SURFACE ÉTERNELLE

Matière et coloris stables dans le temps, exceptionnelle résistance aux taches.

CONVIENT À TOUTE UTILISATION EN EXTÉRIEUR

Résistant au gel et ignifuge, il résiste à tous les agents atmosphériques, aux changements de température, aux acides, aux moisissures et au sel. Combinable avec les produits pour intérieur pour une parfaite coordination esthétique sans interruptions.

ÉCOLOGIQUE

Créé dans le respect et la protection de l'environnement.

FORMATI SIZES



± 20 mm



soluzioni
decorative

Accenti preziosi per progetti coordinati

Exquisite details for coordinated projects

Le collezioni Panaria si arricchiscono di decorazioni ricercate per applicazioni raffinate a rivestimento e a pavimento, capaci di dare uno stile e una personalità esclusiva ai vostri ambienti.

The Panaria collections are enhanced with refined decorations for sophisticated applications on floor and wall coverings, lending a unique style and personality to your rooms.

MASSIMA VERSATILITÀ DI SOLUZIONI

Da scoprire in un'ampia gamma di formati e varianti creative.

STILE MADE IN ITALY PER DECORAZIONI ESCLUSIVE

Curate in ogni minimo dettaglio per spazi sofisticati e contemporanei.

PROGETTI COORDINATI E INTEGRATI

Grazie all'abbinamento tra pavimenti e rivestimenti in gres porcellanato o monoporosa.

MIX & MATCH DI DECORI E SUPERFICI

Armonia di effetti materici differenti per composizioni creative, in tonalità o a contrasto, trasversali a ogni tipologia di ambiente.

SOLUTIONS THAT OFFER MAXIMUM VERSATILITY

Discover a wide range of sizes and creative variants.

MADE IN ITALY FOR EXCLUSIVE DECORATIONS

Sophisticated, contemporary spaces with meticulous attention to detail.

COORDINATED AND INTEGRATED PROJECTS

Thanks to the combination of porcelain stoneware or monoporosa floor and wall coverings.

MIX & MATCH OF DECORATIONS AND SURFACES

Different harmonious tactile effects for creative compositions that match or contrast and that are suited to any kind of room.

Die Panaria Kollektionen werden durch ausgesuchte Dekos für erlesene Verkleidungen oder Fußböden ergänzt, die Ihren Ambiente einen exklusiven Stil und eine ganz eigene Persönlichkeit geben.

Les collections Panaria se sont enrichies de décors raffinés pour des applications murales et au sol raffinées, capables de donner un style et une personnalité exclusifs à vos pièces.

ABSOLUT VIELSEITIGE LÖSUNGEN

Durch eine umfangreiche Auswahl an Formaten und kreativen Varianten.

MADE IN ITALY STIL FÜR EXKLUSIVE DEKORATIONEN

Für raffinierte und moderne Räume bis ins kleinste Detail.

KOORDINIERT UND INTEGRIERTE PROJEKTE

Durch die Kombination von Fußböden und Verkleidungen aus Feinsteinzeug oder Einbrandverfahren (Monoporosa).

MIX & MATCH VON DEKOS UND OBERFLÄCHEN

Harmonie zwischen verschiedenen Materialeffekten für kreative Ton-in-Ton- oder Kontrast-Kompositionen in allen Typen von Ambiente.

POLYVALENCE MAXIMALE DES SOLUTIONS

A découvrir dans une large gamme de formats et de variations créatives.

FABRIQUÉ EN STYLE ITALIEN POUR DES DÉCORATIONS EXCLUSIVES

Grâce à un processus de pressage unique.

DES PROJETS COORDONNÉS ET INTÉGRÉS

Grâce à la combinaison entre des sols et des revêtements muraux en grès cérame ou à porosité unique.

MIX & MATCH DE DÉCORS ET DE SURFACES

Harmonie de différents effets matériels pour des compositions créatives, en nuances ou en contrastes, transversales à chaque type d'environnement.



P R () T E C T

Protezione antibatterica

Antibacterial protection

L'esclusiva tecnologia Panariagroup per pavimenti e rivestimenti antibatterici ad altissime performance. Per un abitare sano, sicuro e protetto.

The exclusive Panariagroup technology for antimicrobial floor and wall coverings with the highest performance. To live healthily, safe and secure.



AZIONE POTENTE

elimina i batteri e ne impedisce la proliferazione

POWERFUL ACTION

eliminates microbes and prevents their reproduction

LEISTUNGSSTARKE WIRKUNG

eliminiert Bakterien und verhindert die Vermehrung

ACTION PUISSANTE

élimine les bactéries et empêche leur prolifération



EFFICACIA ETERNA

grazie alla tecnologia integrata in modo permanente nel prodotto

ETERNAL EFFECTIVENESS

thanks to the technology permanently integrated into the product

DAUERHAFT WIRKSAMKEIT

dank der permanent im Produkt integrierten Technologie

EFFICACITÉ ÉTERNELLE

grâce à la technologie intégrée de façon permanente dans le produit

Die exklusive Technologie Panariagroup für antibakterielle und hochleistungsfähige Fußböden und Verkleidungen. Für ein gesundes, sicheres und geschütztes Wohnen.

La technologie exclusive de Panariagroup pour les revêtements de sols et de murs antibactériens à hautes performances. Pour un habitat sain, sûr et protégé.



PROTEZIONE CONTINUA

sempre attivo, 24 ore su 24, con e senza luce solare

CONTINUOUS PROTECTION

always active, 24 hours a day, with and without sunlight

DAUERSCHUTZ

rund um die Uhr aktiv, mit oder ohne Sonnenlicht

PROTECTION CONTINUE

toujours actif, 24 heures sur 24, avec et sans lumière du soleil



QUALITÀ GARANTITA

dalla partnership con MICROBAN®

GUARANTEED QUALITY

by the partnership with MICROBAN®

GARANTIERTE QUALITÄT

dank der Partnership mit MICROBAN®

QUALITÉ GARANTIE

du partenariat avec MICROBAN®

protect.panariagroup.it

PANARIAgroup



Fiordo

La semplicità di abitare

The simplicity of living

La Linea Fiordo rappresenta l'anima accessibile di Panaria: incontra ogni esigenza dell'abitare contemporaneo, grazie a superfici ceramiche essenziali ma curate, dal design immediato e trasversale, capaci di valorizzare ogni tipo di applicazione in ambito residenziale e commerciale. Un' estetica pulita e di nuova generazione, collezioni compatte, versatili e di facile scelta, contraddistinte dalla qualità tecnica ed estetica garantita da Panariagroup, per un insieme di prodotti che rinnovano costantemente il proprio stile, in linea con i trend di mercato e le esigenze di un pubblico in continuo divenire.

The Linea Fiordo represents Panaria's accessible side: it meets every contemporary living need thanks to essential, yet meticulous surfaces with an immediate and versatile design that are capable of enhancing every type of application in residential and commercial environments. A clean and next-generation aesthetic and compact, versatile and easy-to-choose collections distinguished by the technical and aesthetic quality guaranteed by Panariagroup. The result is a set of products whose style is constantly renewed in line with market trends and the demands of an ever-changing public.

Die Linea Fiordo steht für den zugänglichen Panaria Geist: sie erfüllt alle Ansprüche an das moderne Wohnen durch essentielle, aber sehr gepflegte Keramikflächen mit unmittelbarem und übergreifendem Design, die jeden Anwendungstyp in Wohn- und Gewerbebereichen aufwerten. Eine klare Ästhetik der neuen Generation, kompakte, vielseitige und leicht auszuwählende Kollektionen, die sich durch die von Panariagroup garantierte technische Qualität und Ästhetik auszeichnen, für eine Gesamtheit von Produkten, die ihren Stil im Einklang mit den Markttrends und den Ansprüchen eines ständig wachsenden Publikums konstant erneuern.

La Linea Fiordo représente l'âme accessible de Panaria: elle répond à tous les besoins de l'habitat contemporain, grâce à des surfaces céramiques essentielles mais soignées, avec un design immédiat et transversal, capables de valoriser tout type d'application dans les complexes résidentiels et commerciaux. Des lignes nettes et de nouvelle génération, collections compactes, polyvalentes et faciles à choisir, caractérisées par la qualité technique et esthétique garantie par Panariagroup, pour un ensemble de produits qui renouvellent constamment leur style, en accord avec les tendances du marché et les exigences d'un public en constante évolution.



Il nostro Gruppo
Our Group



Panariagroup

Nel tempo e nel mondo l'eccellenza ceramica

Throughout time and around the world,
ceramic excellence

Eccellere, nel mondo della ceramica di alta qualità, significa saper generare sempre prodotti a elevata componente tecnologica e impreziosirli con la massima attenzione estetica, con la cura di ogni dettaglio. Per soddisfare al meglio i gusti della fascia più elevata ed esigente del mercato, Panariagroup adotta da sempre la formula dell'eccellenza, unendo storica sapienza artigianale e attitudine all'avanguardia tecnologica. Con un impegno fondamentale ad agire e operare sempre con responsabilità. Con oltre 40 anni di esperienza, Panariagroup è oggi una realtà internazionale con un cuore fortemente italiano, presente con 8 brand in oltre 130 paesi nel mondo grazie a una vasta e capillare rete commerciale.

To excel in the world of high quality ceramics means knowing how to continuously create highly technological products and how to enhance them through the utmost attention to aesthetics and detail. Panariagroup has always adhered to the highest standards of excellence, combining its history of skilful artisan craftsmanship with cutting edge technology. This approach is intrinsically linked to a fundamental commitment to always act and operate responsibly. With over 40 years of experience, Panariagroup is an international company with a strong Italian soul and an extensive sales network with 8 brands in over 130 countries all over the world.

Exzellenz in der Welt der hochwertigen Keramik bedeutet zu wissen, wie man kontinuierlich Produkte herstellt, die nicht nur eine hohe technologische Komponente aufweisen, sondern die mit besonderem Augenmerk auf die Ästhetik bis ins kleinste Detail realisiert werden. Panariagroup arbeitet seit jeher mit der Formel der Exzellenz, um dem Geschmack des anspruchsvollsten Marktsegments gerecht zu werden. Historische Handwerkskunst vereint sich mit technologischem Fortschritt, wobei ein verantwortungsvolles Handeln absolute Voraussetzung ist. Mit mehr als 40 Jahren Erfahrung ist die Panariagroup heute eine internationale Realität mit einem starken italienischen Herzen, die dank eines großen und weit verbreiteten Handelsnetzes weltweit mit 8 Marken in über 130 Ländern präsent ist.

Exceller, dans le monde de la céramique de haute qualité, signifie toujours savoir créer des produits à composante technologique élevée et les enrichir avec la plus grande attention esthétique, en soignant tous les détails. Pour satisfaire au mieux les goûts de la plage la plus élevée et la plus exigeante du marché, Panariagroup adopte depuis toujours la formule de l'excellence, unissant la connaissance historique artisanale et l'attitude technologiquement à l'avant-garde. Avec un engagement fondamental à agir et œuvrer toujours de manière responsable. Avec plus de 40 ans d'expérience, Panariagroup est aujourd'hui un groupe international avec un cœur fortement italien, présente avec 8 marques dans plus de 130 pays dans le monde, grâce à un vaste réseau commercial à tous les niveaux.



Panariagroup

Ceramiche per la qualità della vita

Ceramics for the quality of your life

Bellezza, Innovazione, Sostenibilità

Panariagroup è leader mondiale nei pavimenti e rivestimenti di alta qualità. Con processi produttivi che rispettano l'ambiente e prodotti pensati per un nuovo modo di concepire l'architettura e l'abitare.

Schönheit, Innovation, Nachhaltigkeit

Panariagroup ist ein international führender Hersteller von qualitativ hochwertigen Wand- und Bodenbelägen. Die Produktion erfolgt umweltschonend, und die Produkte sind auf ein neues Konzept des Bauens und Wohnens ausgelegt.

Beauty, Innovation, Sustainability

Panariagroup is a world leader in high quality ceramic surfaces for floor and wall coverings. Its production processes respect the environment and its products are designed for a new way of conceiving architecture and living.

Esthétique, Innovation, Durabilité

Panariagroup, leader mondial des sols et revêtements de haute qualité garantit des processus de production respectueux de l'environnement et des produits conçus pour envisager l'architecture et le logement différemment.

Per conoscere di più sull'impegno e sulle iniziative concrete di Panariagroup, è possibile consultare il Bilancio di Sostenibilità 2018, scaricabile dal sito panariagroup.it o richiedibile via mail a sustainability@panariagroup.it

To find out more about Panariagroup's commitment and specific initiatives, you can refer to the Sustainability Report 2018, which can be downloaded here at panariagroup.it or requested via email at sustainability@panariagroup.it

Mehr zum Engagement und zu den konkreten Initiativen von Panariagroup erfahren Sie aus dem Nachhaltigkeitsbericht 2018, den Sie von der Website panariagroup.it downloaden oder per E-Mail an sustainability@panariagroup.it anfordern können.

Pour en savoir plus sur les engagements et sur les initiatives concrètes de Panariagroup, vous pouvez consulter le Rapport de Durabilité 2018, téléchargeable sur le site panariagroup.it ou en envoyant une demande par e-mail à sustainability@panariagroup.it



LA CERAMICA. UNA SCELTA SICURA.

CERAMICS. A SAFE CHOICE. / LA CÉRAMIQUE, UN CHOIX SÛR. / KERAMIK. EINE SICHERE WAHL.



SICURA
SAFE / SÛRE / SICHER

IGIENICA
HYGIENIC / HYGIÉNIQUE / HYGIENISCH

DURA A LUNGO
LONG-LASTING / DURE LONGTEMPS / LANGLEBIG

NON EMETTE SOSTANZE CHIMICHE NOCIVE
ZERO VOCs / ZÉRO COV / NULL VOCs

NON BRUCIA
IT DOES NOT BURN / NE BRÛLE PAS /
BRENNT NICHT

RESISTENTE
RESISTANT / RÉSISTANTE / BESTÄNDIG

VERSATILE
VERSATILE / POLYVALENTE / VIELSEITIG

STABILE
STABLE / STABLE / STABIL

RICICLABILE
RECYCLABLE / RECYCLABLE / WIEDERVERWERTBAR

AMA L'AMBIENTE
ENVIRONMENT-FRIENDLY / RESPECTE
L'ENVIRONNEMENT / UMWELTSCHONEND

Panariagroup La ceramica nella sua forma migliore

Ceramics at their best

La ceramica è un materiale dalle prestazioni uniche e straordinarie. Panariagroup si distingue con prodotti di qualità superiore.

Ceramics offer unique and outstanding performance. Panariagroup stands out for its superior quality products.

PIÙ SALUBRI
Grazie all'integrazione della tecnologia antibatterica Protect.

PIÙ FACILI DA PULIRE
Grazie alle nostre esclusive tecniche di lavorazione delle superfici.

PIÙ VERSATILI E ADATTI AD OGNI IMPIEGO
Grazie ad un'ampia disponibilità di tecnologie e componenti ad elevata performance che consentono di ottenere prodotti adatti a destinazioni d'uso differenti.

PIÙ SOSTENIBILI
Grazie a un processo produttivo estremamente efficiente in termini di rispetto delle norme ambientali, del consumo di acqua, energia e materie prime.

HEALTHIER
Thanks to the integrated Protect antimicrobial technology.

EASIER TO CLEAN
Thanks to our exclusive surface processing techniques.

MORE VERSATILE AND SUITABLE FOR EVERY USE
Thanks to the wide availability of high-performance technologies and components that allow you to obtain products suitable for different uses.

MORE SUSTAINABLE
Thanks to a production process that is extremely efficient in terms of compliance with environmental standards and consumption of water, energy and raw materials.

La céramique est un matériau aux performances uniques et extraordinaires. Panariagroup se distingue par ses produits de qualité supérieure.

Keramik ist ein Material mit einzigartigen und ausgezeichneten Leistungen. Panariagroup zeichnet sich durch ihre hochwertigen Qualitätsprodukte aus.

PLUS SAINS
Grâce à l'intégration de la technologie antibactérienne Protect.

PLUS FACILES À NETTOYER
Grâce à nos techniques exclusives de traitement de surface.

PLUS POLYVALENTS ET ADAPTÉS À TOUS LES USAGES
Grâce à une vaste disponibilité de technologies et de composants à haute performance, qui permettent d'obtenir des produits adaptés à des usages différents.

PLUS DURABLES
Grâce à un processus de production extrêmement efficace en termes de respect des normes environnementales, de consommation d'eau, d'énergie et de matières premières.

GESÜNDER
Dank der Integration der antibakteriellen Technologie Protect.

EINFACHER ZU REINIGEN
Dank unserer exklusiven Verarbeitungstechniken der Oberflächen.

VIELSEITIGER UND FÜR JEDEN EINSATZ GEEIGNET
Dank einer breiten Verfügbarkeit von Technologien und Komponenten mit hoher Leistung, die es ermöglichen, Produkte für verschiedene Einsatzbereiche zu erhalten.

NACHHALTIGER
Dank einem extrem effizienten Produktionsprozess im Hinblick auf Einhaltung der Umweltnormen, sowie Wasser-, Strom- und Rohstoffverbrauch.

Le collezioni



Collections

La bellezza di poter scegliere la superficie ideale

The beauty of being able to choose the perfect surface

Le collezioni Panaria offrono un'ampia gamma di superfici ispirate a elementi naturali e a suggestivi effetti materici, pensate per incontrare una molteplicità di stili e gusti differenti.

The Panaria collections offer a wide range of surfaces inspired by natural elements and striking material effects, designed to satisfy a variety of different styles and tastes.

Die Panaria Kollektionen bieten eine große Auswahl an Oberflächen an, die an natürlichen Elementen und an suggestiven Materialeffekten inspiriert sind und entwickelt wurden, um zahlreichen verschiedenen Stilen und Geschmacksrichtungen gerecht zu werden.

Les collections Panaria offrent une large gamme de surfaces inspirées d'éléments naturels et d'effets matériels évocateurs, conçues pour répondre à une grande variété de styles et de goûts.



Effetto Cemento
Concrete look



Effetto Pietra
Stone look



Effetto Marmo
Marble look



Effetto Legno
Wood look

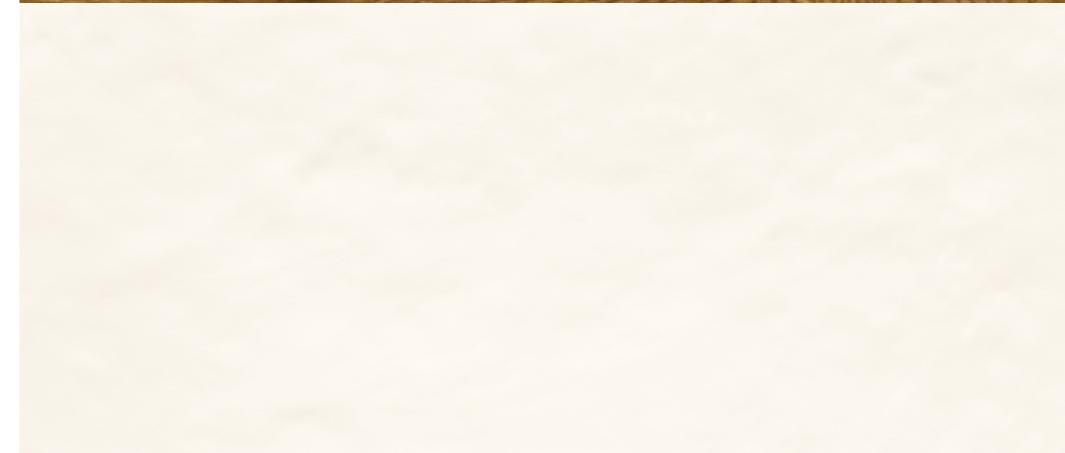

Effetto Cromatico
Chromatic look

Legenda

Legend_Legende_Légende

Simbologia

Key to symbols_Symbole_Symbologie



Pavimento
Floor
Bodenbelag
Revêtement de sol



Rivestimento
Wall
Wandverkleidung
Revêtement de mur



Spessore
Thickness
Stärke
Épaisseur



Resistenza allo scivolamento
Slip resistance
Rutschfestigkeit
Résistance au glissement



Resistenza all'abrasione profonda
Deep abrasion resistant
Widerstand gegen Tiefenabrieb
Résistance à l'abrasion profonde

Note

Note_Anmerkungen_Remarques

FINITURA LUX: La finitura LUX è consigliata, oltre che per rivestimenti, anche per pavimenti in ambienti residenziali o commerciale leggero non sottoposti ad elevate sollecitazioni, ove non siano richieste prestazioni antiscivolo. La presenza sporadica di piccole disuniformità o di puntini sulla superficie è da ritenersi come caratteristica del materiale e della particolare lavorazione. Qualora il prodotto sia posto a diretto contatto con l'esterno, si consiglia di utilizzare soluzioni protettive al fine di prevenire la formazione di graffi.

LUX SURFACE FINISHES: The LUX finishes are recommended, as well as for wall cladding, also for flooring in residential or light commercial areas that are not subjected to heavy traffic, where anti-slip characteristics are not required. The occasional presence of small inconsistencies or little spots on the surface is to be considered a characteristic of the material and of its unique production process. If the product is laid in direct contact with external environments, it is recommended to use protective solutions to reduce the formation of scratches.

LUX OBERFLÄCHE: Die Oberfläche LUX wird nicht nur für Wandverkleidungen empfohlen, sondern auch für Böden in Wohn- bzw. Gewerbebereichen, die keiner hohen Belastung ausgesetzt sind und bei denen keine rutschhemmende Wirkung erforderlich ist. Das sporadische Vorhandensein von kleinen Unebenheiten oder Punkten auf der Oberfläche ist als ein Merkmal von Material und besonderer Verarbeitung zu betrachten. Wird das Produkt in direkten Kontakt mit der Außenseite gebracht, wird empfohlen, Schutzlösungen zu verwenden, um die Bildung von Kratzern zu vermeiden.

FINITION LUX: En plus des revêtements, la finition LUX est également recommandée pour les sols dans les environnements résidentiels ou commerciaux légers peu soumis à des contraintes élevées, pour lesquels aucune prestation antidérapante n'est requise. La présence sporadique de petites irrégularités ou de points à la surface doit être considérée comme une caractéristique du matériau et de sa fabrication particulière. Si le produit est placé en contact direct avec l'extérieur, il est conseillé d'utiliser des solutions de protection afin d'éviter la formation de rayures.

In aree caratterizzate dal passaggio di carichi pesanti concentrati non è consigliato l'utilizzo di prodotti a spessore ridotto. In areas that are subjected to heavy concentrated loads it is not recommended to use low thickness products. In Bereichen, die schwerer Belastung ausgesetzt sind, ist die Verwendung von Produkten mit reduzierter Stärke nicht empfehlenswert. Dans les zones à passage de charges lourdes concentrées, l'utilisation de produits d'épaisseur réduite n'est pas recommandée.

Variazioni cromatiche

Color variations_Farbvariationen_Variations chromatiques



V1 - Aspetto uniforme
V1 - Uniform appearance
V1 - Einheitliches Aussehen
V1 - Aspect uniforme

V2 - Lieve variazione
V2 - Slight variation
V2 - Geringe Variation
V2 - Variation légère

V3 - Moderata variazione
V3 - Moderate variation
V3 - Mäßige Variation
V3 - Variation modérée

V4 - Forte variazione
V4 - Substantial variation
V4 - Grosses Farbspiel
V4 - Forte stonationalisation

Destinazioni d'uso

Intended use_Verwendungszwecke_Domaines d'emploi



RESIDENZIALE_RESIDENTIAL_WOHNGEBIET_RÉSIDENTIEL

Cucine, bagni, living e ogni altro ambiente di uso residenziale.

Kitchens, bathrooms, living rooms and other residential environments.

Küchen, Badezimmer, Wohnzimmer und alle sonstigen Wohnbereiche.

Cuisines, salles de bains, salons et tout autre espace à usage résidentiel.



COMMERCIALE LEGGERO_LIGHT COMMERCIAL

LEICHTE GEWERBLICHE ANWENDUNGEN_COMMERCIAL LÉGER

Uffici, uffici aperti al pubblico, sale d'attesa, negozi, bagni pubblici, aree comuni condominiali, sale di ristoranti, autosaloni, bar, cinema, ambulatori/cliniche, camere e bagni di hotel. In aree caratterizzate da passaggi obbligati non è consigliato l'utilizzo di prodotti con finitura LUX.

Offices, offices open to the general public, waiting rooms, shops, public bathrooms, common apartment block areas, restaurant dining rooms, car showrooms, bars, cinemas, surgeries/clinics, hotel rooms and bathrooms. In areas subjected to forced traffic, it is not advisable to use products with the LUX finishes.

Büroräume, öffentliche Büros, Wartezimmer, Geschäfte, öffentliche Toiletten, Gemeinschaftsflächen in Mehrfamilienhäusern, Gaststätten, Autohäuser, Cafés, Kinos, Praxen/Kliniken, Hotelzimmer und -badezimmer. In Bereichen mit obligatorischen Durchgängen ist der Einsatz von Produkten mit den Oberflächen LUX nicht empfohlen.

Bureaux, bureaux ouverts au public, salles d'attente, magasins, toilettes publiques, espaces communs de logements collectifs, salles de restaurants, salons automobiles, bars, cinémas, cabinets médicaux/cliniques, chambres et salles de bains d'hôtels. Dans les zones caractérisées par des passages obligatoires, l'utilisation de produits avec une finition LUX n'est pas recommandée.



ESTERNI_OUTDOOR_AUSSENBEREICHE_EXTÉRIEURS

Prevalentemente per ambienti esterni nei quali è richiesta una pavimentazione con prestazioni antiscivolo.

Mainly for external areas that require flooring with anti-slip characteristics.

Vor allem für Außenbereiche, in denen ein rutschfester Boden erforderlich ist.

Principalement pour les environnements extérieurs où un sol antidérapant est requis.



COMMERCIALE INTENSIVO_INTENSIVE COMMERCIAL

INTENSIVE GEWERBLICHE ANWENDUNGEN_COMMERCIAL INTENSIF

Aree comuni di centri commerciali, hall di hotel, mense, fast food, discoteche, ospedali, scuole, musei, luoghi di culto, aeroporti, stazioni.

Common areas of shopping centres, hotel foyers, canteens, fast food restaurants, dance clubs, hospitals, schools, museums, places of worship, airports, stations.

Gemeinschaftsbereiche in Einkaufszentren, Hotelhallen, Kantinen, Fastfood-Restaurants, Diskotheken, Krankenhäuser, Schulen, Museen, Kultstätten, Flughäfen, Bahnhöfe.

Zones communes de centres commerciaux, halls d'hôtels, cantines, fast-foods, discothèques, hôpitaux, écoles, musées, lieux de culte, aéroports, gares.



Effetto pietra



Stone look



Bioarch



BARGE GIALLA SPAZZOLATA



BARGE GRIGIA SPAZZOLATA



BARGE GIALLA STRUTTURATO



BARGE GRIGIA STRUTTURATO

GRES A MASSA COLORATA_COLOURED-BODY STONEWARE



± 9 mm
± 9,5 mm
± 12 mm



60x60 cm Rect
24"x24"
60,3x60,3 cm
24"x24"



30x60 cm Rect
12"x24"
30x60,3 cm
12"x24"



15x60 cm Rect
6"x24"



20x41 cm
8"x16^{1/8}"



20x30,5 cm
8"x12"



20x20 cm
8"x8"

GRES A MASSA COLORATA_COLOURED-BODY STONEWARE 20 mm



± 20 mm



60x60 cm Rect
24"x24"
60,3x60,3 cm
24"x24"



PAVIMENTO / FLOOR Barge Grigia Strutturato 20x20 cm - 8"x8" _Barge Grigia Strutturato 20x30,5 cm - 8"x12" _Barge Grigia Strutturato 20x41 cm - 8"x16 1/8"



RIVESTIMENTO / WALL Barge Gialla Spazzolata 15x60 cm Rect - 6"x24" _Bio Wood Barge Gialla 30x30 cm Rect - 12"x12" _Bio Line Barge Gialla 30x60 cm Rect - 12"x24"
PAVIMENTO / FLOOR Barge Gialla Spazzolata 60x60 cm Rect _24"x24"



PAVIMENTO / FLOOR Barge Grigia Spazzolata 60x60 cm Rect - 24"x24" _Bio Line Barge Grigia 30x60 cm Rect - 12"x24"



PAVIMENTO / FLOOR Barge Grigia Strutturato 60x60 cm Rect - 24"x24" 20 mm

BARGE GIALLA SPAZZOLATA



BARGE GRIGIA SPAZZOLATA



BARGE GIALLA STRUTTURATO



BARGE GRIGIA STRUTTURATO



GRES A MASSA COLORATA_COLOURED-BODY STONEWARE



60x60 cm Rect - 24"x24"
Barge Gialla Spazzolata PGWBK201
Barge Grigia Spazzolata PGWBK301
60,3x60,3 cm - 24"x24"
Barge Gialla Spazzolata PGWBK001
Barge Grigia Spazzolata PGWBK101



30x60 cm Rect - 12"x24"
Barge Gialla Spazzolata PG-BK201
Barge Grigia Spazzolata PG-BK301

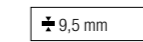

15x60 cm Rect - 6"x24"
Barge Gialla Spazzolata PG1BK201
Barge Grigia Spazzolata PG1BK301

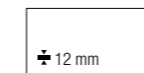

30x60,3 cm - 12"x24"
Barge Gialla Strutturato PG-BK00
Barge Grigia Strutturato PG-BK10



20x41 cm - 8"x16 1/8"
Barge Gialla Strutturato PGKBK05
Barge Grigia Strutturato PGKBK15



20x30,5 cm - 8"x12"
Barge Gialla Strutturato PGBBK05
Barge Grigia Strutturato PGBBK15



20x20 cm - 8"x8"
Barge Gialla Strutturato PGEBK05
Barge Grigia Strutturato PGEBK15

GRES A MASSA COLORATA_COLOURED-BODY STONEWARE **20 mm**



60x60 cm Rect - 24"x24"
Barge Gialla Strutturato PGWBKS0
Barge Grigia Strutturato PGWBKS1
60,3x60,3 cm - 24"x24"
Barge Gialla Strutturato PGWBK0S
Barge Grigia Strutturato PGWBK1S

DESTINAZIONI D'USO_INTENDED USE: SPAZZOLATA STRUTTURATO

DATI TECNICI_TECHNICAL DATA:

GRES A MASSA COLORATA COLOURED-BODY STONEWARE		GRES A MASSA COLORATA COLOURED-BODY STONEWARE	
+	9 / 9,5 / 12 mm		20 mm
	DIN 51130: R11 Strutturato R10 Spazzolata DIN 51097: C (A+B+C) Strutturato A Spazzolata BCR TORTUS: $\mu > 0,40$ ANSI A326.3: DCOF $\geq 0,42$ BS 7976-2: PTV 36+WET (SI.96) Strutturato	DIN 51130: R11 DIN 51097: C (A+B+C) BCR TORTUS: $\mu > 0,40$ ANSI A326.3: DCOF $\geq 0,42$ BS 7976-2: PTV 36+WET (SI.96 - SL.55)	
	EN 101: MOHS 9 CTI 81-7 ANNEX A: MOHS 9		
	ANSI A137.1: V4 Strutturato V3 Spazzolata	ANSI A137.1: V3	

SOLUZIONI DI POSA_LAYING SOLUTIONS

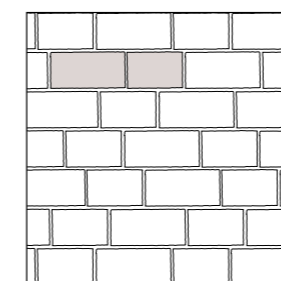

20x30,5 (42,66%) - 20x41 (57,34%)

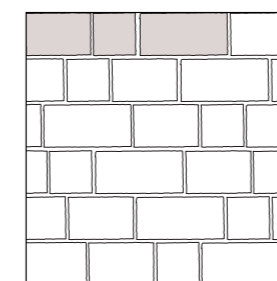

20x20 (21,86%) - 20x30,5 (33,33%)
20x41 (44,81%)

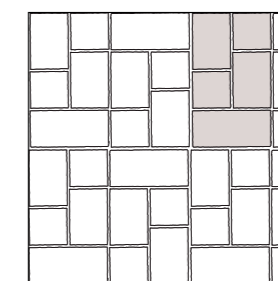

20x20 (28,17%) - 20x30,5 (42,96%)
20x41 (28,87%)

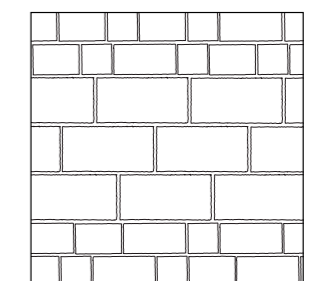

20x20 - 20x30,5 - 20x41
30x60,3

Fuga consigliata: vedi pag. 381_Suggested joint: see pag. 381_Empfohlene Fuge: siehe Seite 381_Joint conseillé : voir page 381

Bioarch

DECORI_DECORS

GRES A MASSA COLORATA_COLOURED-BODY STONEWARE

BARGE GIALLA SPAZZOLATA



MURETTO
29,7x58,4 cm Rect - 11^{3/4}"x23"
± 9,5 mm
PG-BK2M



BIO FOREST
30x60 cm Rect - 12"x24"
± 9,5 mm
PG-BK26



BIO LINE
30x60 cm Rect - 12"x24"
± 9,5 mm
PG-BK27

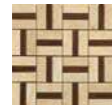

BIO WOOD
30x30 cm Rect - 12"x12"
± 9,5 mm
PGZBK25

BARGE GRIGIA SPAZZOLATA



MURETTO
29,7x58,4 cm Rect - 11^{3/4}"x23"
± 9,5 mm
PG-BK3M



BIO FOREST
30x60 cm Rect - 12"x24"
± 9,5 mm
PG-BK36



BIO LINE
30x60 cm Rect - 12"x24"
± 9,5 mm
PG-BK37









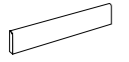

BIO WOOD
30x30 cm Rect - 12"x12"
± 9,5 mm
PGZBK35

BIO FOREST:
Posare solo a parete_Recommended only for wall applications_Nur an der Wand verlegen_Recommandé seulement pour les revêtements

PEZZI SPECIALI_TRIM PIECES

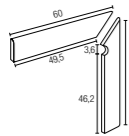
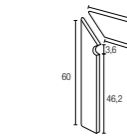
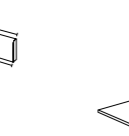
GRES A MASSA COLORATA_COLOURED-BODY STONEWARE

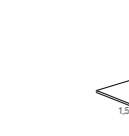
						
	BATTISCOPIA 10x60 cm Rect - 4"x24" ± 10 mm	BATTISCOPIA 10x60,3 cm - 4"x24" ± 10 mm	GRADONE TORO VUOTO BORDO 30x34 cm - 12"x13 ^{3/8} " ± 9,5 mm	GRADONE TORO VUOTO ANGOLARE 34x34 cm - 13 ^{3/8} "x13 ^{3/8} " ± 9,5 mm	RACCORDO* 1,2x30 cm - 1/2"x12"	ANGOLO RACCORDO* 1,2x1,2 cm - 1/2"x1/2"
BARGE GIALLA SPAZZOLATA	PGRBK21	PGRBK27	PGEBK20	PGEBK21	PGZBK21	PGZBK22
BARGE GRIGIA SPAZZOLATA	PGRBK31	PGRBK37	PGEBK30	PGEBK31	PGZBK31	PGZBK32
						
	BATTISCOPIA SCALA DX (kit 2 pezzi) 10x60 cm - 5"x24" ± 10 mm	BATTISCOPIA SCALA SX (kit 2 pezzi) 10x60 cm - 5"x24" ± 10 mm	GRADINO** 30x30 cm Rect - 12"x12" ± 9,5 mm	GRADONE A COSTA RETTA 30x34 cm - 12"x13 ^{3/8} " ± 12 mm	ELEMENTO "L" 15x30x4 cm Rect - 6"x12"x1 ^{9/16} " ± 9 mm	
BARGE GIALLA SPAZZOLATA	PGZBKD2	PGZBKS2	PGDBK20	BARGE GIALLA STRUTTURATO	PGEBK00	PGZBKA0
BARGE GRIGIA SPAZZOLATA	PGZBKD3	PGZBKS3	PGDBK30	BARGE GRIGIA STRUTTURATO	PGEBK10	PGZBKA1

* Posare solo all'interno_Strictly for interiors_Nur im Innenraum zu verlegen_Poser seulement à l'intérieur







** Privo di fresature anticivolo_Version without non-slip milled cuts_Ohne rutschhemmnde Rillen_Marche sans rainures antidérapant

Trattandosi di pezzi artigianali possono verificarsi piccole variazioni dimensionali_Handmade pieces: light size variations may occur_Da es sich um handgemachte Teile handelt, können es kleine dimensionale Veränderungen auftreten_Étant donné qu'il s'agit de pièces faites à la main il peut y avoir des petits changements dimensionnels

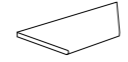
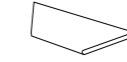
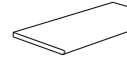
Bioarch

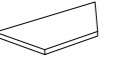
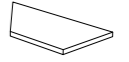
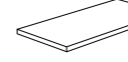

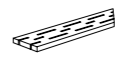

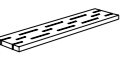

PEZZI SPECIALI_TRIM PIECES

GRES A MASSA COLORATA_COLOURED-BODY STONEWARE 20 mm

						
	COSTA TORO ANGOLARE DX 30x60 cm Rect - 12"x24"	COSTA TORO ANGOLARE SX 30x60 cm Rect - 12"x24"	COSTA TORO 30x60 cm Rect - 12"x24"	COSTA TORO GRIP 30x60 cm Rect - 12"x24"	COSTA RETTA ANGOLARE DX 30x60 cm Rect - 12"x24"	COSTA RETTA ANGOLARE SX 30x60 cm Rect - 12"x24"
BARGE GIALLA STRUTTURATO	PGDBKK2	PGDBKK0	PGDBKF0	PGDBKJ0	PGDBKD2	PGDBKD0
BARGE GRIGIA STRUTTURATO	PGDBKK3	PGDBKK1	PGDBKF1	PGDBKJ1	PGDBKD3	PGDBKD1
						
	COSTA RETTA 30x60 cm Rect - 12"x24"	COSTA RETTA GRIP 30x60 cm Rect - 12"x24"	GRIGLIA ANGOLARE DX 15x60 cm Rect - 6"x24"	GRIGLIA ANGOLARE SX 15x60 cm Rect - 6"x24"	GRIGLIA 15x60 cm Rect - 6"x24"	
BARGE GIALLA STRUTTURATO	PGDBKC0	PGDBKGO	PGDBKA2	PGDBKA0	PGDBKZO	
BARGE GRIGIA STRUTTURATO	PGDBKC1	PGDBKG1	PGDBKA3	PGDBKA1	PGDBKZ1	

- Venduti solo a scatole complete_Only full boxes sold_Nur volle Karton_Vendus par boîte complete
- Lavorati solo su richiesta_Manufactured only upon special request_Nur auf Anfrage_Seulement à la demande
- Per tutti i pz speciali consegna 30 gg_For all trim pieces 30 days delivery_Formteile haben 30 Tage Lieferzeit_Livraison en 30 jours pour toutes les pièces spéciales

IMBALLAGGI E PESI_PACKINGS AND WEIGHTS

DESCRIZIONE Description	± mm	FORMATI Sizes	SCATOLA_Box				PALLET		
									
FONDO STRUTTURATO	12	30x60,3	7	32,2	1,266	-	32	1030,4	40,52
FONDO STRUTTURATO	9	20x41	13	21	1,066	-	54	1134	57,56
FONDO STRUTTURATO	9	20x30,5	20	23,10	1,22	-	48	1108,8	58,56
FONDO STRUTTURATO	9	20x20	30	25	1,20	-	45	1125	54
FONDO SPAZZOLATA	9,5	60x60 ^{RECT}	4	31,8	1,44	-	32	1018	46,1
FONDO SPAZZOLATA	9,5	60,3x60,3	4	31,8	1,454	-	32	1018	46,5
FONDO SPAZZOLATA	9,5	30x60 ^{RECT}	8	31,8	1,44	-	32	1018	46,1
FONDO SPAZZOLATA	9,5	15x60 ^{RECT}	12	23,3	1,08	-	40	933	43,2
DECORO BIO FOREST	9,5	30x60 ^{RECT}	5	21,5	0,90	-	-	-	-
MOSAICO BIO LINE	9,5	30x60 ^{RECT}	4	15,7	0,72	-	30	471	21,6
MOSAICO BIO WOOD	9,5	30x30 ^{RECT}	4	7,2	0,36	-	60	432	21,6
MURETTO	9,5	29,7x58,4	4	15,7	0,694	-	30	471	20,8
RACCORDO NATURALE	-	1x30	8	0,40	0,029	-	-	-	-
ANGOLO RACCORDO NATURALE	-	1x1	10	0,07	0,001	-	-	-	-
BATTISCOPIA NATURALE	10	10x60 ^{RECT}	12	15,48	0,72	7,20	60	928,80	43,20
BATTISCOPIA NATURALE	10	10x60,3	16	20	0,965	9,648	48	960	46,31
BATTISCOPIA SCALA KIT (2 PZ.) NATURALE	10	10x60	5	8,5	0,425	-	-	-	-
GRADONE TORO VUOTO BORDO NATURALE	9,5	30x34	6	15,4	0,612	-	30	462	18,4
GRADONE TORO VUOTO ANGOLARE NATURALE	9,5	34x34	2	5,4	0,223	-	46	250	10,3
GRADINO NATURALE	9,5	30x30 ^{RECT}	12	23,4	1,08	-	40	937	43,20
GRADONE A COSTA RETTA STRUTTURATO	12	30x34	6	21	0,612	1,2	30	630	18,36
ELEMENTO "L" STRUTTURATO	9	15x30x4	8	9,6	0,36	2,4	48	460,80	17,28
FONDO STRUTTURATO	20	60x60 ^{RECT}	2	33,6	0,720	-	32	1075,2	23,04
FONDO STRUTTURATO	20	60,3x60,3	2	33,5	0,727	-	32	1072	23,27
COSTA TORO STRUTTURATO	20	30x60 ^{RECT}	1	8,125	0,180	-	100	812,5	18
ANGOLO COSTA TORO STRUTTURATO	20	30x60 ^{RECT}	1	6,10	0,135	-	100	610	13,50
COSTA TORO GRIP STRUTTURATO	20	30x60 ^{RECT}	1	8,125	0,180	-	100	812,5	18
COSTA RETTA STRUTTURATO	20	30x60 ^{RECT}	1	8,125	0,180	-	100	812,5	18
ANGOLO COSTA RETTA STRUTTURATO	20	30x60 ^{RECT}	1	6,10	0,135	-	100	610	13,50
COSTA RETTA GRIP STRUTTURATO	20	30x60 ^{RECT}	1	8,125	0,180	-	100	812,5	18
GRIGLIA STRUTTURATO	20	15x60 ^{RECT}	2	8	0,18	-	100	800	18
ANGOLO GRIGLIA STRUTTURATO	20	15x60 ^{RECT}	2	7	0,157	-	100	700	15,75



Discover



WHITE



PLAN



ORIGIN



SUN

GRES A MASSA COLORATA_COLOURED-BODY STONEWARE



± 8 mm
± 9,5 mm



60x120 cm Rect
24"x48"



60x60 cm Rect
24"x24"
60,3x60,3 cm
24"x24"



30x60 cm Rect
12"x24"
30x60,3 cm
12"x24"



20x60 cm Rect
8"x24"



15x60 cm Rect
6"x24"

7,5x60 cm Rect
3"x24"

5x60 cm Rect
2"x24"

GRES A MASSA COLORATA_COLOURED-BODY STONEWARE 20 mm



± 20 mm



60x120 cm Rect
24"x48"



60x60 cm Rect
24"x24"
60,3x60,3 cm
24"x24"



PAVIMENTO / FLOOR Plan 15x60 cm Rect - 6"x24" _Plan 20x60 cm Rect - 8"x24" _Plan 30x60 cm Rect - 12"x24"
Plan Strutturato 30x60,3 cm - 12"x24"



RIVESTIMENTO / WALL White 30x60 cm Rect - 12"x24" _Mosaico a sbalzo White 30x60 cm Rect - 12"x24"
PAVIMENTO / FLOOR Origin 60x60 cm Rect - 24"x24"



PAVIMENTO / FLOOR Sun Strutturato 30x60,3 cm - 12"x24"



PAVIMENTO / FLOOR White Strutturato 60,3x60,3 cm - 24"x24" 20 mm

Discover

PROTECT
ANTIBATTERICO - ANTIMICROBIAL

WHITE



PLAN



ORIGIN



SUN



Discover

GRES A MASSA COLORATA_COLOURED-BODY STONEWARE



60x120 cm Rect - 24"x48"

White NATURALE PGXD13R5
Plan NATURALE PGXD11R5
Origin NATURALE PGXD10R5
Sun NATURALE PGXD12R5



60x60 cm Rect - 24"x24"

White NATURALE PGWDI31P
Plan NATURALE PGWDI11P
Origin NATURALE PGWDI01P
Sun NATURALE PGWDI21P

60,3x60,3 cm - 24"x24"

White NATURALE PGWDI30P
Plan NATURALE PGWDI10P
Origin NATURALE PGWDI00P
Sun NATURALE PGWDI20P



30x60 cm Rect - 12"x24"

White NATURALE PG-DI31
Plan NATURALE PG-DI11
Origin NATURALE PG-DI01
Sun NATURALE PG-DI21

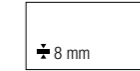

30x60,3 cm - 12"x24"

White NATURALE PG-DI30
Plan NATURALE PG-DI10
Origin NATURALE PG-DI00
Sun NATURALE PG-DI20



20x60 cm Rect - 8"x24"

White NATURALE PG2DI30
Plan NATURALE PG2DI10
Origin NATURALE PG2DI00
Sun NATURALE PG2DI20

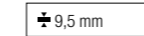

15x60 cm Rect - 6"x24"

White NATURALE PG1DI30
Plan NATURALE PG1DI10
Origin NATURALE PG1DI00
Sun NATURALE PG1DI20

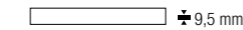

7,5x60 cm Rect - 3"x24"

White NATURALE PGRDI30
Plan NATURALE PGRDI10
Origin NATURALE PGRDI00
Sun NATURALE PGRDI20

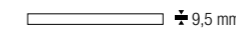

5x60 cm Rect - 2"x24"

White NATURALE PGODI30
Plan NATURALE PGODI10
Origin NATURALE PGODI00
Sun NATURALE PGODI20

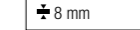

30x60,3 cm - 12"x24"

White STRUTTURATO* PG-DIS3
Plan NATURALE PGODI10
Origin STRUTTURATO* PG-DIS0
Sun STRUTTURATO* PG-DIS2

GRES A MASSA COLORATA_COLOURED-BODY STONEWARE 20 mm

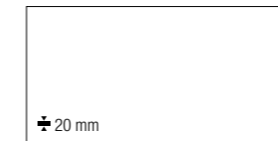

60x120 cm Rect - 24"x48"

White STRUTTURATO* PGXDIS31
Origin STRUTTURATO* PGXDIS01
Sun STRUTTURATO* PGXDIS21

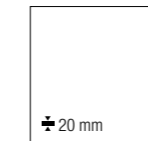

60x60 cm Rect - 24"x24"

White STRUTTURATO* PGWDIS8
Origin STRUTTURATO* PGWDIS5
Sun STRUTTURATO* PGWDIS7

60,3x60,3 cm Rect - 24"x24"

White STRUTTURATO* PGWDIS3
Origin STRUTTURATO* PGWDIS0P
Sun STRUTTURATO* PGWDIS2P

DESTINAZIONI D'USO_INTENDED USE: NATURALE STRUTTURATO

DATI TECNICI_TECHNICAL DATA:

GRES A MASSA COLORATA COLOURED-BODY STONEWARE		GRES A MASSA COLORATA COLOURED-BODY STONEWARE	
+	8 / 9,5 mm		20 mm
	DIN 51130: R9 Naturale R11 Strutturato		DIN 51130: R11
	DIN 51097: C (A+B+C) Strutturato		DIN 51097: C (A+B+C)
	BCR TORTUS: $\mu > 0,40$		BCR TORTUS: $\mu > 0,40$
	ANSI A326.3: DCOF $\geq 0,42$		ANSI A326.3: DCOF $\geq 0,42$
	BS 7976-2: PTV 36+WET (SL96 - SL55) Strutturato		BS 7976-2: PTV 36+wet (SL96 - SL55)
	ANSI A137.1: V2		ANSI A137.1: V2
PROTECT ANTIBATTERICO - ANTIMICROBIAL			

* Protezione antibatterica non presente_No antimicrobial protection_Der Antibakterielle Schutz nicht vorhanden_Protection antibactérienne pas présente

Discover

DECORI_DECORS

GRES A MASSA COLORATA_COLOURED-BODY STONEWARE

WHITE



MOSAICO A SBALZO
30x30 cm Rect - 12"x12"
± 9,5 mm
PGZDI3M

PLAN



MOSAICO A SBALZO
30x30 cm Rect - 12"x12"
± 9,5 mm
PGZDI1M

ORIGIN



MOSAICO A SBALZO
30x30 cm Rect - 12"x12"
± 9,5 mm
PGZDI0M

SUN

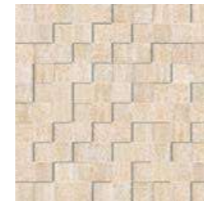

MOSAICO A SBALZO
30x30 cm Rect - 12"x12"
± 9,5 mm
PGZDI2M

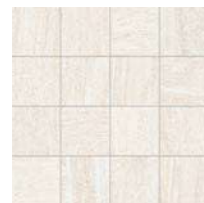

MOSAICO 16 PEZZI
30x30 cm Rect - 12"x12"
± 9,5 mm
PGZDI35



MOSAICO 16 PEZZI
30x30 cm Rect - 12"x12"
± 9,5 mm
PGZDI15



MOSAICO 16 PEZZI
30x30 cm Rect - 12"x12"
± 9,5 mm
PGZDI05



MOSAICO 16 PEZZI
30x30 cm Rect - 12"x12"
± 9,5 mm
PGZDI25

PEZZI SPECIALI_TRIM PIECES

GRES A MASSA COLORATA_COLOURED-BODY STONEWARE

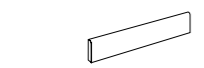

BATTISCOPA
10x60 cm Rect - 4"x24"
± 10 mm
NATURALE



BATTISCOPA
10x60,3 cm - 4"x24"
± 10 mm
NATURALE

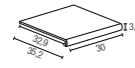

GRADONE TORO VUOTO BORDO
30x34 cm - 12"x13^{3/8}"
± 9,5 mm
NATURALE

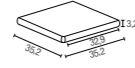

GRADONE TORO VUOTO ANGOLARE DX
34x34 cm - 13^{3/8}"x13^{3/8}"
± 9,5 mm
NATURALE

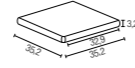

GRADONE TORO VUOTO ANGOLARE SX
34x34 cm - 13^{3/8}"x13^{3/8}"
± 9,5 mm
NATURALE

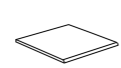

GRADINO
30x30 cm Rect - 12"x12"
± 9,5 mm
NATURALE

	WHITE	PLAN	ORIGIN	SUN
BATTISCOPA	PGRDIR3	PGRDIR1	PGRDIR0	PGRDIR2
BATTISCOPA	PGRDIB3	PGRDIB1	PGRDIB0	PGRDIB2
GRADONE TORO VUOTO BORDO	PGEDI30	PGEDI10	PGEDI00	PGEDI20
GRADONE TORO VUOTO ANGOLARE DX	PGEDI31	PGEDI11	PGEDI01	PGEDI21
GRADONE TORO VUOTO ANGOLARE SX	PGEDI32	PGEDI12	PGEDI02	PGEDI22
GRADINO	PGDDI30	PGDDI10	PGDDI00	PGDDI20

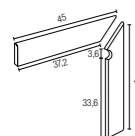

BATTISCOPA SCALA DX (kit 2 pezzi)
10x45 cm - 4"x18"
± 10 mm
NATURALE

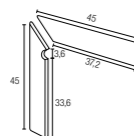

BATTISCOPA SCALA SX (kit 2 pezzi)
10x45 cm - 4"x18"
± 10 mm
NATURALE



RACCORDO*
1x30 cm Rect - 3/8"x12"
NATURALE



ANGOLO RACCORDO*
1x1 cm - 3/8"x3/8"
NATURALE

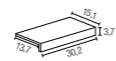

ELEMENTO *L*
15x30x4 cm Rect - 4"x12"x1^{9/16}"
± 9 mm
STRUTTURATO

	WHITE	PLAN	ORIGIN	SUN
BATTISCOPA SCALA DX	PGZDI3D	PGZDI1D	PGZDI0D	PGZDI2D
BATTISCOPA SCALA SX	PGZDI3S	PGZDI1S	PGZDI0S	PGZDI2S
RACCORDO*	PGZDI30	PGZDI10	PGZDI00	PGZDI20
ANGOLO RACCORDO*	PGZDI31	PGZDI11	PGZDI01	PGZDI21
ELEMENTO *L*	PGZDIA3	PGZDIA1	PGZDIA0	PGZDIA2

* Protezione antibatterica non presente_No antimicrobial protection_Der Antibakterielle Schutz nicht vorhanden_Protection antibactérienne pas présente

Trattandosi di pezzi artigianali possono verificarsi piccole variazioni dimensionali_Handmade pieces: light size variations may occur_Da es sich um handgemachte Teile handelt, können es kleine dimensionale Veränderungen auftreten_Étant donné qu'il s'agit de pièces faites à la main il peut y avoir des petits changements dimensionnels

Discover

PEZZI SPECIALI_TRIM PIECES

GRES A MASSA COLORATA_COLOURED-BODY STONEWARE **20 mm**

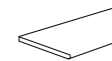

COSTA TORO ANGOLARE DX
30x60 cm Rect - 12"x24"
STRUTTURATO

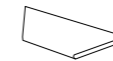

COSTA TORO ANGOLARE SX
30x60 cm Rect - 12"x24"
STRUTTURATO

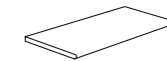

COSTA TORO
30x60 cm Rect - 12"x24"
STRUTTURATO



COSTA TORO GRIP
30x60 cm Rect - 12"x24"
STRUTTURATO

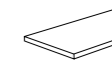

COSTA RETTA ANGOLARE DX
30x60 cm Rect - 12"x24"
STRUTTURATO

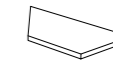

COSTA RETTA ANGOLARE SX
30x60 cm Rect - 12"x24"
STRUTTURATO

	WHITE	ORIGIN	SUN
COSTA TORO ANGOLARE DX	PGDDIK6	PGDDIK4	PGDDIK5
COSTA TORO ANGOLARE SX	PGDDIK3	PGDDIK0	PGDDIK2
COSTA TORO	PGDDIF3	PGDDIF0	PGDDIF2
COSTA TORO GRIP	PGDDIJ3	PGDDIJ0	PGDDIJ2
COSTA RETTA ANGOLARE DX	PGDDID6	PGDDID4	PGDDID5
COSTA RETTA ANGOLARE SX	PGDDID3	PGDDID0	PGDDID2

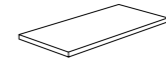

COSTA RETTA
30x60 cm Rect - 12"x24"
STRUTTURATO

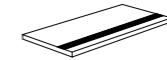

COSTA RETTA GRIP
30x60 cm Rect - 12"x24"
STRUTTURATO

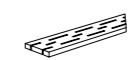

GRIGLIA ANGOLARE DX
15x60 cm Rect - 6"x24"
STRUTTURATO



GRIGLIA ANGOLARE SX
15x60 cm Rect - 6"x24"
STRUTTURATO

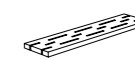

GRIGLIA
15x60 cm Rect - 6"x24"
STRUTTURATO

	WHITE	ORIGIN	SUN
COSTA RETTA	PGDDIC3	PGDDIC0	PGDDIC2
COSTA RETTA GRIP	PGDDIG3	PGDDIG0	PGDDIG2
GRIGLIA ANGOLARE DX	PGDDIA6	PGDDIA4	PGDDIA5
GRIGLIA ANGOLARE SX	PGDDIA3	PGDDIA0	PGDDIA2
GRIGLIA	PGDDIZ3	PGDDIZ0	PGDDIZ2

- Venduti solo a scatole complete_Only full boxes sold_Nur volle Karton_Vendus par boîte complete
- Lavorati solo su richiesta_Manufactured only upon special request_Nur auf Anfrage_Seulement à la demande
- Per tutti i pz speciali consegna 30 gg_For all trim pieces 30 days delivery_Formteile haben 30 Tage Lieferzeit_Livraison en 30 jours pour toutes les pièces spéciales

IMBALLAGGI E PESI_PACKINGS AND WEIGHTS

DESCRIZIONE Description	± mm	FORMATI Sizes	SCATOLA_Box			PALLET			
			📦	📊	📏	📦	📊	📏	
FONDO NATURALE	9,5	60x120 ^{RECT}	2	32	1,44	-	36	1150	51,8
FONDO NATURALE	9,5	60x60 ^{RECT}	4	31,8	1,44	-	32	1018	46,1
FONDO NATURALE	9,5	60,3x60,3	4	31,8	1,454	-	32	1018	46,5
FONDO NATURALE	9,5	30x60 ^{RECT}	8	31,8	1,44	-	32	1018	46,1
FONDO NATURALE	8	30x60,3	10	30,1	1,809	-	32	963	57,9
FONDO STRUTTURATO	8	30x60,3	10	30,1	1,809	-	32	963	57,9
FONDO NATURALE	9,5	20x60 ^{RECT}	13	31,9	1,56	-	30	957	46,8
FONDO NATURALE	9,5	15x60 ^{RECT}	16	29,5	1,44	-	32	942	46,1
FONDO NATURALE	9,5	7,5x60 ^{RECT}	15	14,9	0,675	-	40	596	27
FONDO NATURALE	9,5	5x60 ^{RECT}	15	9,4	0,45	-	64	599	28,8
MOSAICO 16 PZ.	9,5	30x30 ^{RECT}	4	7,2	0,36	-	78	562	28,1
MOSAICO A SBALZO	9,5	30x30 ^{RECT}	4	7,2	0,36	-	78	562	28,1
RACCORDO	-	1x30 ^{RECT}	8	0,80	0,024	-	-	-	-
ANGOLO RACCORDO	-	1x1	10	0,07	-	-	-	-	-
BATTISCOPA NATURALE	10	10x60,3	16	20	0,966	9,648	48	960	46,387
BATTISCOPA NATURALE	10	10x60 ^{RECT}	12	15,48	0,72	7,20	60	928,80	43,20
BATTISCOPA SCALA KIT (2 PZ.) NATURALE	10	10x45	5	8,5	0,425	-	-	-	-
GRADINO NATURALE	9,5	30x30 ^{RECT}	13	25,9	1,17	-	40	1036	46,8
GRADONE TORO VUOTO BORDO NATURALE	9,5	30x34	6	14,8	0,612	-	30	445	18,4
GRADONE TORO VUOTO ANGOLARE NATURALE	9,5	34x34	2	5,4	0,223	-	46	250	10,3
ELEMENTO *L* STRUTTURATO	9	15x30x4	8	9,6	0,360	2,4	48	460,8	17,28
FONDO STRUTTURATO	20	60x120 ^{RECT}	1	32,5	0,72	-	32	1040	23,04
FONDO STRUTTURATO	20	60,3x60,3	2	33,5	0,727	-	32	1072	23,27
FONDO STRUTTURATO	20	60x60 ^{RECT}	2	33,6	0,720	-	32	1075,2	23,04
COSTA TORO STRUTTURATO	20	30x60 ^{RECT}	1	8,125	0,180	-	100	812,5	18
ANGOLO COSTA TORO STRUTTURATO	20	30x60 ^{RECT}	1	6,10	0,135	-	100	610	13,50
COSTA TORO GRIP STRUTTURATO	20	30x60 ^{RECT}	1	8,125	0,180	-	100	812,5	18
COSTA RETTA STRUTTURATO	20	30x60 ^{RECT}	1	8,125	0,180	-	100	812,5	18
ANGOLO COSTA RETTA STRUTTURATO	20	30x60 ^{RECT}	1	6,10	0,135	-	100	610	13,50
COSTA RETTA GRIP STRUTTURATO	20	30x60 ^{RECT}	1	8,125	0,180	-	100	812,5	18
GRIGLIA STRUTTURATO	20	15x60 ^{RECT}	2	8	0,180	-	100	800	18
ANGOLO GRIGLIA STRUTTURATO	20	15x60 ^{RECT}	2	7	0,157	-	100	700	15,75



Frame

Fiordo



GLEN



RIVER



PEAK



GROOVE

GRES A MASSA COLORATA_COLOURED-BODY STONEWARE



± 9,5 mm



45x90 cm Rect
18"x36"



60x60 cm Rect
24"x24"
60,3x60,3 cm
24"x24"



30x60 cm Rect
12"x24"

GRES A MASSA COLORATA_COLOURED-BODY STONEWARE **20 mm**



± 20 mm



45x90 cm Rect
18"x36"



60x60 cm Rect
24"x24"
60,3x60,3 cm
24"x24"



RIVESTIMENTO / WALL Glen 30x60 cm Rect - 12"x24" _ Glen Mosaico 30x30 cm Rect - 12"x12"
 PAVIMENTO / FLOOR Glen 60x60 cm Rect - 24"x24"



RIVESTIMENTO / WALL Glen Muretto 30x60 cm Rect - 12"x24"
 PAVIMENTO / FLOOR Groove 45x90 cm Rect - 18"x36"

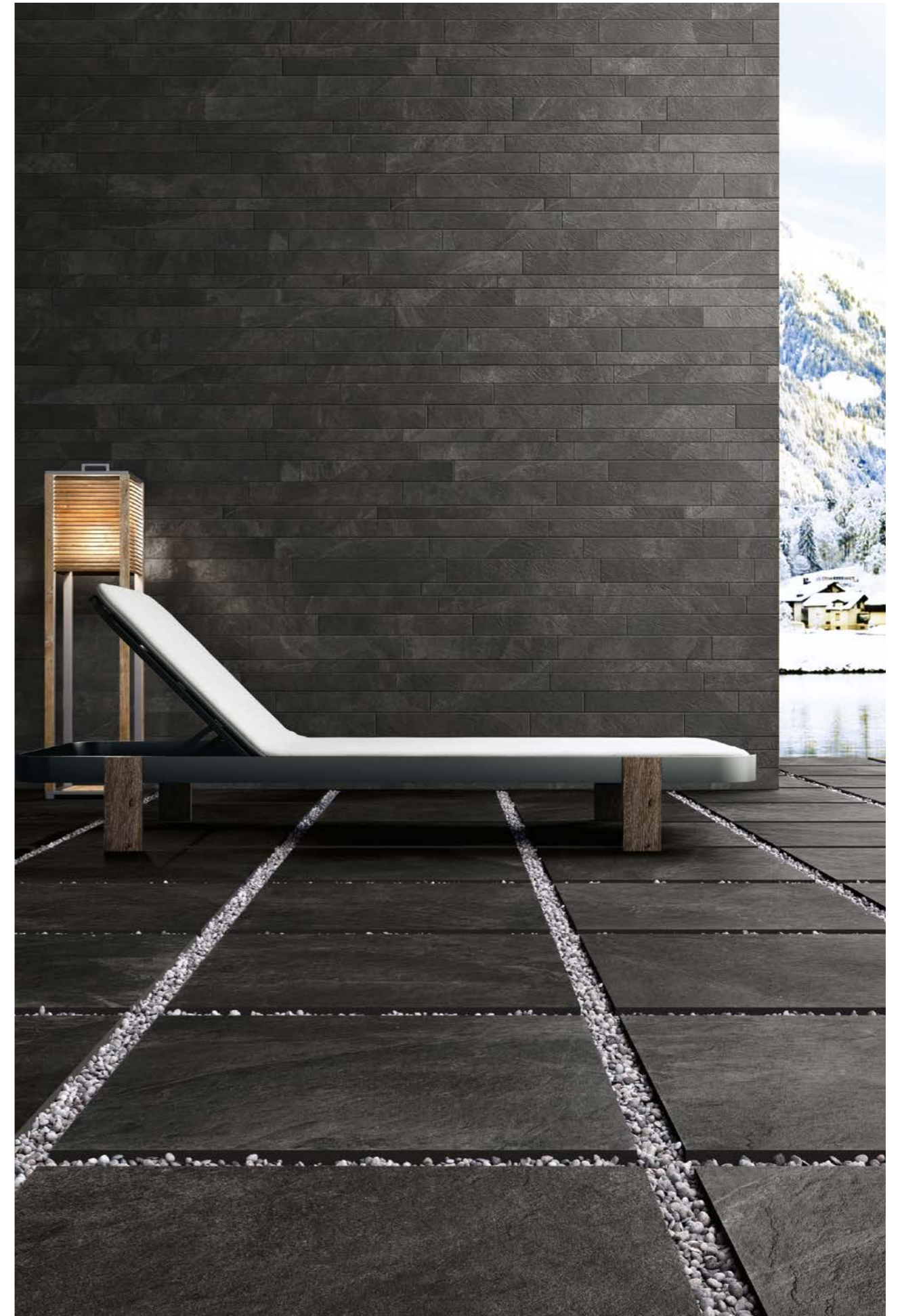

RIVESTIMENTO / WALL Groove Muretto 30x60 cm Rect - 12"x24"
 PAVIMENTO / FLOOR Groove Strutturato 60x60 cm Rect - 24"x24" 20 mm



RIVESTIMENTO / WALL River Muretto 30x60 cm Rect - 12"x24"
 PAVIMENTO / FLOOR River 45x90 cm Rect - 18"x36"

Frame

GLEN



RIVER



PEAK



GROOVE



Frame

GRES A MASSA COLORATA_COLOURED-BODY STONEWARE

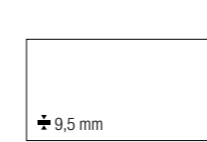

45x90 cm Rect - 18"x36"

Glen NATURALE	FGHFMR0
River NATURALE	FGHFMR3
Peak NATURALE	FGHFMR2
Groove NATURALE	FGHFMR1



60x60 cm Rect - 24"x24"

Glen NATURALE	FGWFM00
River NATURALE	FGWFM03
Peak NATURALE	FGWFM02
Groove NATURALE	FGWFM01
Glen STRUTTURATO	FGWFM05
River STRUTTURATO	FGWFM05
Peak STRUTTURATO	FGWFM25
Groove STRUTTURATO	FGWFM15



30x60 cm Rect - 12"x24"

Glen NATURALE	FG-FMR0
River NATURALE	FG-FMR3
Peak NATURALE	FG-FMR2
Groove NATURALE	FG-FMR1
Glen STRUTTURATO	FG-FM05
River STRUTTURATO	FG-FM35
Peak STRUTTURATO	FG-FM25
Groove STRUTTURATO	FG-FM15

60,3x60,3 cm - 24"x24"

Glen NATURALE	FGWFM00
River NATURALE	FGWFM30
Peak NATURALE	FGWFM20
Groove NATURALE	FGWFM10

GRES A MASSA COLORATA_COLOURED-BODY STONEWARE 20 mm



45x90 cm Rect - 18"x36"

Glen STRUTTURATO	FGHFM60
River STRUTTURATO	FGHFM63
Peak STRUTTURATO	FGHFM62
Groove STRUTTURATO	FGHFM61

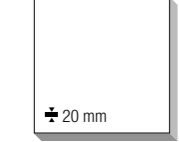

60x60 cm Rect - 24"x24"

Glen STRUTTURATO	FGWFM60
River STRUTTURATO	FGWFM63
Peak STRUTTURATO	FGWFM62
Groove STRUTTURATO	FGWFM61

60,3x60,3 cm - 24"x24"

Glen STRUTTURATO	FGWFM50
River STRUTTURATO	FGWFM53
Peak STRUTTURATO	FGWFM52
Groove STRUTTURATO	FGWFM51

DECORI_DECORS

GRES A MASSA COLORATA_COLOURED-BODY STONEWARE

GLEN



MURETTO 30x60 cm Rect - 12"x24"

9.5 mm

FG-FMM0



MOSAICO 36 PEZZI 30x30 cm Rect - 12"x12"

9.5 mm

FGZFM00

RIVER



MURETTO 30x60 cm Rect - 12"x24"

9.5 mm

FG-FMM3



MOSAICO 36 PEZZI 30x30 cm Rect - 12"x12"

9.5 mm

FGZFM30

PEAK



MURETTO 30x60 cm Rect - 12"x24"

9.5 mm

FG-FMM2



MOSAICO 36 PEZZI 30x30 cm Rect - 12"x12"

9.5 mm

FGZFM20

GROOVE



MURETTO 30x60 cm Rect - 12"x24"

9.5 mm

FG-FMM1



MOSAICO 36 PEZZI 30x30 cm Rect - 12"x12"

9.5 mm

FGZFM10

PEZZI SPECIALI_TRIM PIECES

GRES A MASSA COLORATA_COLOURED-BODY STONEWARE



BATTISCOPA 10x60 cm Rect - 4"x24"

10 mm

NATURALE



BATTISCOPA 10x60,3 cm - 4"x24"

10 mm

NATURALE

GLEN	FGRFMR0	FGRFM00
RIVER	FGRFMR3	FGRFM30
PEAK	FGRFMR2	FGRFM20
GROOVE	FGRFMR1	FGRFM10

DESTINAZIONI D'USO_INTENDED USE: NATURALE STRUTTURATO

DATI TECNICI_TECHNICAL DATA:

GRES A MASSA COLORATA COLOURED-BODY STONEWARE		GRES A MASSA COLORATA COLOURED-BODY STONEWARE	
+	9,5 mm	20 mm	
DIN 51130:	R10 Naturale	DIN 51130:	R11
DIN 51097:	B (A+B) Naturale	DIN 51097:	C (A+B+C)
BCR TORTUS:	$\mu > 0,40$	BCR TORTUS:	$\mu > 0,40$
ANSI A326.3:	DCOF $\geq 0,42$	ANSI A326.3:	DCOF $\geq 0,42$
AS/NZS 4586:	P3 Naturale	AS/NZS 4586:	P4
BS 7976-2:	P4 Strutturato	BS 7976-2:	PTV 36+WET (SI.96 - SI.55)
	PTV 36+WET (SI.96) Naturale		
	PTV 36+WET (SI.96 - SI.55) Strutturato		
	ANSI A137.1: V2		ANSI A137.1: V2

IMBALLAGGI E PESI_PACKINGS AND WEIGHTS

DESCRIZIONE Description	+ mm	FORMATI Sizes	SCATOLA_Box			PALLET			
FONDO NATURALE	9,5	45x90 RECT	3	25,7	1,215	-	30	770	36,5
FONDO NATURALE	9,5	60x60 RECT	4	31,8	1,44	-	32	1018	46,1
FONDO NATURALE	9,5	60,3x60,3	4	31,8	1,454	-	32	1018	46,5
FONDO NATURALE	9,5	30x60 RECT	8	31,8	1,44	-	32	1018	46,1
FONDO STRUTTURATO	9,5	60x60 RECT	4	31,8	1,44	-	32	1018	46,1
FONDO STRUTTURATO	9,5	30x60 RECT	8	31,8	1,44	-	32	1018	46,1
MURETTO	9,5	30x60 RECT	4	15,7	0,72	-	30	471	21,6
MOSAICO 36 PZ.	9,5	30x30 RECT	5	10,1	0,45	-	60	604	27
BATTISCOPA NATURALE	10	10x60 RECT	12	15,48	0,72	7,20	60	928,8	43,2
BATTISCOPA NATURALE	10	10x60,3	16	20	0,964	9,648	48	960	46,31
FONDO STRUTTURATO	20	60x60 RECT	2	32,5	0,72	-	32	1040	23,04
FONDO STRUTTURATO	20	60,3x60,3	2	33,5	0,727	-	32	1072	23,27
FONDO STRUTTURATO	20	45x90 RECT	2	36,23	0,81	-	24	869,52	19,44



Horizon



SUNRISE



SUNSET



SKY



CLOUD



STORM

GRES A MASSA COLORATA_COLOURED-BODY STONEWARE



± 9,5 mm



90x90 cm Rect
36"x36"



60x120 cm Rect
24"x48"



60x60 cm Rect
24"x24"
60,3x60,3 cm
24"x24"



30x60 cm Rect
12"x24"

GRES A MASSA COLORATA_COLOURED-BODY STONEWARE **20 mm**



± 20 mm



60x120 cm Rect
24"x48"



RIVESTIMENTO / WALL Storm 30x60 cm Rect - 12"x24" _Mosaico 36 Sky 30x30 cm Rect - 12"x12" _Rails Storm 30x30 cm Rect - 12"x12"
PAVIMENTO / FLOOR Sky 90x90 cm Rect - 36"x36"



RIVESTIMENTO / WALL Cloud 30x60 cm Rect - 12"x24" _Mosaico 36 Cloud 30x30 cm Rect - 12"x12" _Rails Sunrise 30x30 cm Rect - 12"x12"
PAVIMENTO / FLOOR Cloud 60x60 cm Rect_24"x24"

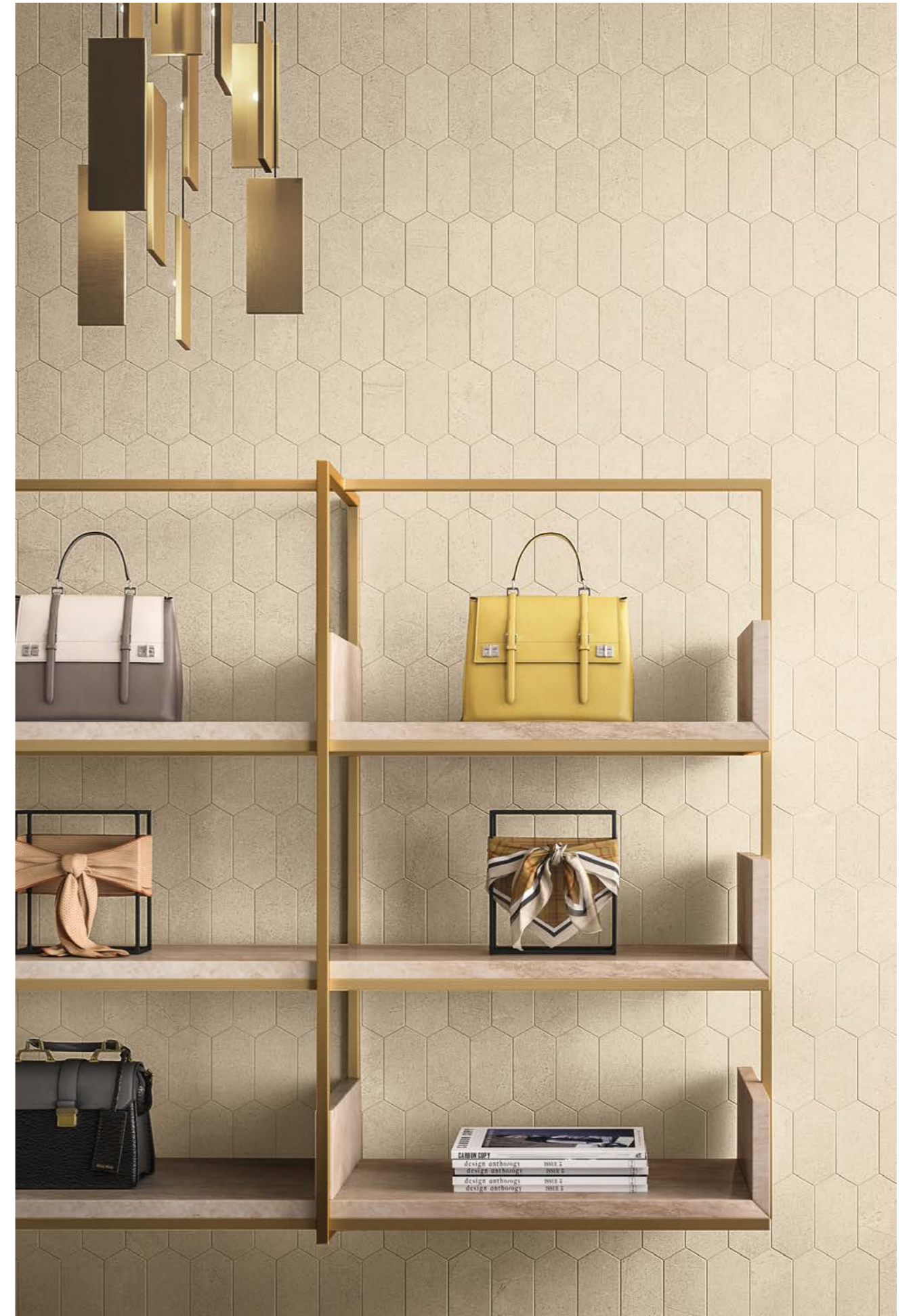

RIVESTIMENTO / WALL Hexagon Sunrise 30x30 cm Rect - 12"x12"



RIVESTIMENTO / WALL Storm Strutturato 30x60 cm Rect - 12"x24"
PAVIMENTO / FLOOR Sunrise Strutturato 60x120 cm Rect - 24"x48" 20 mm_Sunrise Strutturato 60,3x60,3 cm - 24"x24"

Horizon

PROTECT
ANTIBATTERICO - ANTIMICROBIAL

SUNRISE



SUNSET

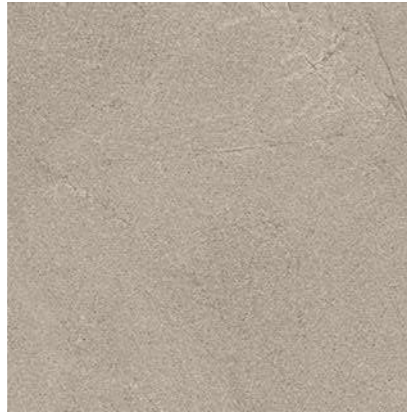

SKY

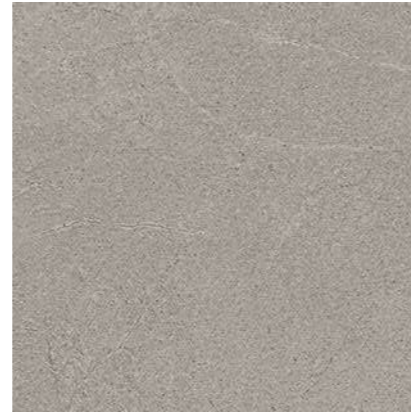

CLOUD

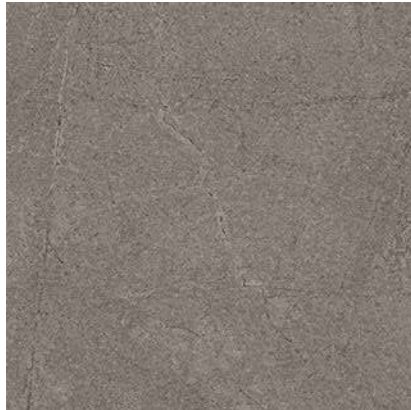

STORM

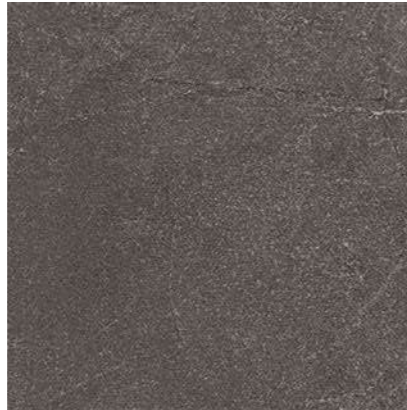

Horizon

GRES A MASSA COLORATA_COLOURED-BODY STONEWARE



90x90 cm Rect - 36"x36"

Sunrise NATURALE PGGHNR31
Sunset NATURALE PGGHNR41
Sky NATURALE PGGHNR11
Cloud NATURALE PGGHNR01
Storm NATURALE PGGHNR21



60x120 cm Rect - 24"x48"

Sunrise NATURALE PGXHN303
Sunset NATURALE PGXHN403
Sky NATURALE PGXHN103
Cloud NATURALE PGXHN003
Storm NATURALE PGXHN203



60x60 cm Rect - 24"x24"

Sunrise NATURALE PGWHNR3
Sunset NATURALE PGWHNR4
Sky NATURALE PGWHNR1
Cloud NATURALE PGWHNR0
Storm NATURALE PGWHNR2
Sunrise STRUTTURATO* PGWHNG3
Sunset STRUTTURATO* PGWHNG4
Cloud STRUTTURATO* PGWHNG0
Storm STRUTTURATO* PGWHNG2



60,3x60,3 cm Rect - 24"x24"

Sunrise STRUTTURATO* PGWHNB3
Sunset STRUTTURATO* PGWHNB4
Cloud STRUTTURATO* PGWHNB0
Storm STRUTTURATO* PGWHNB2

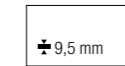

30x60 cm Rect - 12"x24"

Sunrise NATURALE PG-HNR3
Sunset NATURALE PG-HNR4
Sky NATURALE PG-HNR1
Cloud NATURALE PG-HNR0
Storm NATURALE PG-HNR2
Sunrise STRUTTURATO* PG-HNG3
Sunset STRUTTURATO* PG-HNG4
Cloud STRUTTURATO* PG-HNG0
Storm STRUTTURATO* PG-HNG2

GRES A MASSA COLORATA_COLOURED-BODY STONEWARE 20 mm

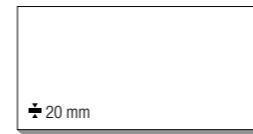

60x120 cm Rect - 24"x48"

Sunrise STRUTTURATO* PGXHNG3
Sunset STRUTTURATO* PGXHNG4
Cloud STRUTTURATO* PGXHNG0
Storm STRUTTURATO* PGXHNG2

DESTINAZIONI D'USO_INTENDED USE: NATURALE STRUTTURATO

DATI TECNICI_TECHNICAL DATA:

GRES A MASSA COLORATA COLOURED-BODY STONEWARE	GRES A MASSA COLORATA COLOURED-BODY STONEWARE
9,5 mm	20 mm
DIN 51130: R10 Naturale R11 Strutturato DIN 51097: C (A+B+C) Strutturato BCR TORTUS: $\mu > 0,40$ ANSI A326.3: DCOF $\geq 0,42$	DIN 51130: R11 DIN 51097: C (A+B+C) BCR TORTUS: $\mu > 0,40$ ANSI A326.3: DCOF $\geq 0,42$
ANSI A137.1: V2	ANSI A137.1: V2
PROTECT ANTIBATTERICO - ANTIMICROBIAL	

* Protezione antibatterica non presente_No antimicrobial protectio_Der Antibakterielle Schutz nicht vorhanden_Protection antibactérienne pas présente

Horizon

DECORI_DECORS

GRES A MASSA COLORATA_COLOURED-BODY STONEWARE

<p>SUNRISE WALL 3D 30x58 cm Rect - 12"x23" ± 9,5 mm PGZHNW3</p>	<p>SUNSET WALL 3D 30x58 cm Rect - 12"x23" ± 9,5 mm PGZHNW4</p>	<p>SKY WALL 3D 30x58 cm Rect - 12"x23" ± 9,5 mm PGZHNW1</p>	<p>CLOUD WALL 3D 30x58 cm Rect - 12"x23" ± 9,5 mm PGZHNW0</p>	<p>STORM WALL 3D 30x58 cm Rect - 12"x23" ± 9,5 mm PGZHNW2</p>
<p>MOSAICO 36 PEZZI 30x30 cm Rect - 12"x12" ± 9,5 mm PGZHNM3</p>	<p>MOSAICO 36 PEZZI 30x30 cm Rect - 12"x12" ± 9,5 mm PGZHNM4</p>	<p>MOSAICO 36 PEZZI 30x30 cm Rect - 12"x12" ± 9,5 mm PGZHNM1</p>	<p>MOSAICO 36 PEZZI 30x30 cm Rect - 12"x12" ± 9,5 mm PGZHNM0</p>	<p>MOSAICO 36 PEZZI 30x30 cm Rect - 12"x12" ± 9,5 mm PGZHNM2</p>
<p>RAILS 30x30 cm Rect - 12"x12" ± 9,5 mm PGZHNR3</p>	<p>RAILS 30x30 cm Rect - 12"x12" ± 9,5 mm PGZHNR4</p>	<p>RAILS 30x30 cm Rect - 12"x12" ± 9,5 mm PGZHNR1</p>	<p>RAILS 30x30 cm Rect - 12"x12" ± 9,5 mm PGZHNR0</p>	<p>RAILS 30x30 cm Rect - 12"x12" ± 9,5 mm PGZHNR2</p>
<p>HEXAGON 30x30 cm Rect - 12"x12" ± 9,5 mm PGZHNH3</p>	<p>HEXAGON 30x30 cm Rect - 12"x12" ± 9,5 mm PGZHNH4</p>	<p>HEXAGON 30x30 cm Rect - 12"x12" ± 9,5 mm PGZHNH1</p>	<p>HEXAGON 30x30 cm Rect - 12"x12" ± 9,5 mm PGZHNH0</p>	<p>HEXAGON 30x30 cm Rect - 12"x12" ± 9,5 mm PGZHNH2</p>

PEZZI SPECIALI_TRIM PIECES

GRES A MASSA COLORATA_COLOURED-BODY STONEWARE

<p>BATTISCOPIA 10x60 cm Rect - 4"x24" ± 10 mm NATURALE</p>	<p>ANGOLO GRADONE A COSTA RETTA 34x34 cm - 13³³°x13³³° ± 9,5 mm NATURALE</p>	<p>GRADONE A COSTA RETTA 30x34 cm - 12"x13³³° ± 9,5 mm NATURALE</p>	<p>BATTISCOPIA SCALA DX (kit 2 pezzi) 10x45 cm Rect - 4"x18" ± 10 mm NATURALE</p>	<p>BATTISCOPIA SCALA SX (kit 2 pezzi) 10x45 cm Rect - 4"x18" ± 10 mm NATURALE</p>	<p>ELEMENTO "L" 15x30x4 cm - 6"x12"x1³¹/₁₆" ± 9 mm STRUTTURATO*</p>
SUNRISE	PGRHN30	PGEHN31	PGEHN30	PGZHN3D	PGZHN3S
SUNSET	PGRHN40	PGEHN41	PGEHN40	PGZHN4D	PGZHN4S
SKY	PGRHN10	PGEHN11	PGEHN10	PGZHN1D	PGZHN1S
CLOUD	PGRHN00	PGEHN01	PGEHN00	PGZHN0D	PGZHN0S
STORM	PGRHN20	PGEHN21	PGEHN20	PGZHN2D	PGZHN2S

* Protezione antibatterica non presente_No antimicrobial protection_Der Antibakterielle Schutz nicht vorhanden_Protection antibactérienne pas présente

Trattandosi di pezzi artigianali possono verificarsi piccole variazioni dimensionali_Handmade pieces: light size variations may occur_Da es sich um handgemachte Teile handelt, können es kleine dimensionale Veränderungen auftreten_Étant donné qu'il s'agit de pièces faites à la main il peut y avoir des petits changements dimensionnels

Horizon

PEZZI SPECIALI_TRIM PIECES

GRES A MASSA COLORATA_COLOURED-BODY STONEWARE **20 mm**

<p>COSTA TORO ANGOLARE DX 30x60 cm Rect - 12"x24" STRUTTURATO*</p>	<p>COSTA TORO ANGOLARE SX 30x60 cm Rect - 12"x24" STRUTTURATO*</p>	<p>COSTA TORO 30x60 cm Rect - 12"x24" STRUTTURATO*</p>	<p>COSTA TORO GRIP 30x60 cm Rect - 12"x24" STRUTTURATO*</p>	<p>COSTA RETTA ANGOLARE DX 30x60 cm Rect - 12"x24" STRUTTURATO*</p>	<p>COSTA RETTA ANGOLARE SX 30x60 cm Rect - 12"x24" STRUTTURATO*</p>
SUNRISE	PGDHNK8	PGDHNK9	PGDHN3	PGDHNJ3	PGDHND8
SUNSET	PGDHNK6	PGDHNK7	PGDHN4	PGDFMJ4	PGDHND6
CLOUD	PGDHNK0	PGDHNK1	PGDHN0	PGDHNJ0	PGDHND0
STORM	PGDHNK4	PGDHNK5	PGDHN2	PGDHNJ2	PGDHND4
<p>COSTA RETTA 30x60 cm Rect - 12"x24" STRUTTURATO*</p>	<p>COSTA RETTA GRIP 30x60 cm Rect - 12"x24" STRUTTURATO*</p>	<p>GRIGLIA ANGOLARE DX 15x60 cm Rect - 6"x24" STRUTTURATO*</p>	<p>GRIGLIA ANGOLARE SX 15x60 cm Rect - 6"x24" STRUTTURATO*</p>	<p>GRIGLIA 15x60 cm Rect - 6"x24" STRUTTURATO*</p>	
SUNRISE	PGDHN3	PGDHN4	PGDHNA8	PGDHNA9	PGDHNZ3
SUNSET	PGDHN4	PGDHN3	PGDHNA6	PGDHNA7	PGDHNZ4
CLOUD	PGDHN0	PGDHN0	PGDHNA0	PGDHNA1	PGDHNZ0
STORM	PGDHN2	PGDHN2	PGDHNA4	PGDHNA5	PGDHNZ2

* Protezione antibatterica non presente_No antimicrobial protection_Der Antibakterielle Schutz nicht vorhanden_Protection antibactérienne pas présente

Venduti solo su scatole complete_Only full boxes sold_Nur volle Karton_Vendus par boîte complete

Lavorati solo su richiesta_Manufactured only upon special request_Nur auf Anfrage_Seulement à la demande

Per tutti i pz speciali consegna 30 gg_For all trim pieces 30 days delivery_Formteile haben 30 Tage Lieferzeit_Livraison en 30 jours pour toutes les pièces spéciales

IMBALLAGGI E PESI_PACKINGS AND WEIGHTS

DESCRIZIONE Description	± mm	FORMATI Sizes	SCATOLA_Box				PALLET		
FONDO NATURALE	9,5	60x120 ^{RECT}	2	31,8	1,44	-	36	1145	51,8
FONDO NATURALE	9,5	90x90 ^{RECT}	2	34,6	1,62	-	25	865	40,5
FONDO NATURALE	9,5	60x60 ^{RECT}	4	31,8	1,44	-	32	1018	46,1
FONDO NATURALE	9,5	30x60 ^{RECT}	8	31,8	1,44	-	32	1018	46,1
FONDO STRUTTURATO	9,5	60x60 ^{RECT}	4	31,8	1,44	-	32	1018	46,1
FONDO STRUTTURATO	9,5	60,3x60,3	4	31,8	1,454	-	32	1018	46,5
FONDO STRUTTURATO	9,5	30x60 ^{RECT}	8	31,8	1,44	-	32	1018	46,1
MOSAICO 36	9,5	30x30 ^{RECT}	4	7,3	0,36	-	78	571	28,1
RAILS	9,5	30x30 ^{RECT}	6	11,8	0,54	-	60	708	32,4
WALL 3D	9,5	30x60 ^{RECT}	4	15,7	0,696	-	24	377	16,7
EXAGON	9,5	30x30 ^{RECT}	4	6,2	0,282	-	30	185	8,5
BATTISCOPIA NATURALE	10	10x60 ^{RECT}	12	15,48	0,72	7,20	60	928,8	43,20
BATTISCOPIA SCALA KIT (2 PZ.) NATURALE	10	10x45	5	8,5	0,425	-	-	-	-
GRADONE A COSTA RETTA NATURALE	9,5	30x34	6	17,1	0,612	-	30	513	18,4
ANGOLO GRADONE A COSTA RETTA NATURALE	9,5	34x34	2	6,3	0,231	-	48	301	11,1
ELEMENTO "L" STRUTTURATO	9	15x30x4	8	9,6	0,36	2,40	48	460,80	17,28
FONDO STRUTTURATO	20	60x120 ^{RECT}	1	32,5	0,72	-	32	1040	23,04
COSTA TORO STRUTTURATO	20	30x60 ^{RECT}	1	8,125	0,18	-	100	812,5	18
ANGOLO COSTA TORO STRUTTURATO	20	30x60 ^{RECT}	1	6,1	0,135	-	100	610	13,5
COSTA TORO GRIP STRUTTURATO	20	30x60 ^{RECT}	1	8,125	0,18	-	100	812,5	18
COSTA RETTA STRUTTURATO	20	30x60 ^{RECT}	1	8,125	0,18	-	100	812,5	18
ANGOLO COSTA RETTA STRUTTURATO	20	30x60 ^{RECT}	1	6,1	0,135	-	100	610	13,5
COSTA RETTA GRIP STRUTTURATO	20	30x60 ^{RECT}	1	8,125	0,18	-	100	812,5	18
GRIGLIA STRUTTURATO	20	15x60 ^{RECT}	2	8	0,18	-	100	800	18
ANGOLO GRIGLIA STRUTTURATO	20	15x60 ^{RECT}	2	7	0,157	-	100	700	15,75



Petra Solis



SOMNIUM



FABULA



MIRUM

GRES A MASSA COLORATA_COLOURED-BODY STONEWARE



± 10 mm



60x60 cm Rect
24"x24"
60,8x60,8 cm
24"x24"



40,4x60,8 cm
16"x24"



40,4x40,4 cm
16"x16"



20x40,4 cm
8"x16"



20x20 cm
8"x8"

GRES A MASSA COLORATA_COLOURED-BODY STONEWARE **20 mm**



± 20 mm



60x60 cm Rect
24"x24"



PAVIMENTO / FLOOR Somnium 60,8x60,8 cm - 24"x24" _Somnium 40,4x60,8 cm - 16"x24" _Somnium 40,4x40,4 cm - 16"x16"
Somnium 20x40,4 cm - 8"x16" _Somnium 20x20 cm - 8"x8"



PAVIMENTO / FLOOR Mirium Strutturato 60x60 cm Rect - 24"x24" 20 mm

Petra Solis

SOMNIUM



FABULA



MIRUM

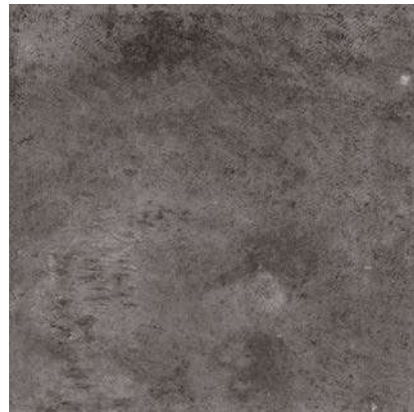

Petra Solis

GRES A MASSA COLORATA_COLOURED-BODY STONEWARE

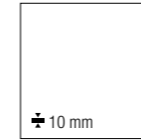

60x60 cm Rect - 24"x24"

Somnium NATURALE PGWPS11
 Fabula NATURALE PGWPS01
 Mirum NATURALE PGWPS31

60,8x60,8 cm - 24"x24"

Somnium NATURALE PGWPS10
 Fabula NATURALE PGWPS00
 Mirum NATURALE PGWPS30



40,4x60,8 cm - 16"x24"

Somnium NATURALE PGJPS10
 Fabula NATURALE PGJPS00
 Mirum NATURALE PGJPS30

Somnium STRUTTURATO PGJPS1

Fabula STRUTTURATO PGJPSS0
 Mirum STRUTTURATO PGJPSS3



40,4x40,4 cm - 16"x16"

Somnium NATURALE PGUPS10
 Fabula NATURALE PGUPS00
 Mirum NATURALE PGUPS30



20x40,4 cm - 8"x16"

Somnium NATURALE PGKPS10
 Fabula NATURALE PGKPS00
 Mirum NATURALE PGKPS30



10 mm

20x20 cm - 8"x8"

Somnium NATURALE PGEPS10
 Fabula NATURALE PGEPS00
 Mirum NATURALE PGEPS30

GRES A MASSA COLORATA_COLOURED-BODY STONEWARE 20 mm



60x60 cm Rect - 24"x24"

Somnium STRUTTURATO PGWPS16
 Mirum STRUTTURATO PGWPS36

DESTINAZIONI D'USO_INTENDED USE: NATURALE STRUTTURATO

DATI TECNICI_TECHNICAL DATA:

GRES A MASSA COLORATA COLOURED-BODY STONEWARE		GRES A MASSA COLORATA COLOURED-BODY STONEWARE	
+	10 mm	20 mm	
DIN 51130:	R10 Naturale R11 Strutturato	DIN 51130:	R11
DIN 51097:	B (A+B) Naturale C (A+B+C) Strutturato	DIN 51097:	C (A+B+C)
BCR TORTUS:	$\mu > 0,40$	BCR TORTUS:	$\mu > 0,40$
ANSI A326.3:	DCOF $\geq 0,42$	ANSI A326.3:	DCOF $\geq 0,42$
AS/NZS 4586:	P4 Strutturato	AS/NZS 4586:	P4
BS 7976-2:	PTV 36+WET (SL.96 - SL.55) Strutturato	BS 7976-2:	PTV 36+WET (SL.96 - SL.55)
UNE ENV 12633:	Classe 3 Strutturato	UNE ENV 12633:	Classe 3
ANSI A137.1:	V3	ANSI A137.1:	V3

Petra Solis

SOLUZIONI DI POSA_LAYING SOLUTIONS

GRES A MASSA COLORATA_COLOURED-BODY STONEWARE



MODULO 1_5 FORMATI
 60,8x60,8 cm = 32,33%
 40,4x40,4 cm = 28,55%
 40,4x60,8 cm = 21,49%
 20x40,4 cm = 14,13%
 20x20 cm = 3,5%

Somnium PGZPSS1
 Fabula PGZPSF1
 Mirum PGZPSM1

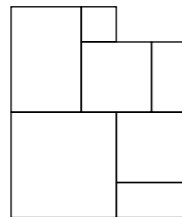

MODULO 2_4 FORMATI
 40,4x40,4 cm = 44,54%
 40,4x60,8 cm = 33,52%
 20x40,4 cm = 11,02%
 20x20 cm = 10,92%

Somnium PGZPSS2
 Fabula PGZPSF2
 Mirum PGZPSM2

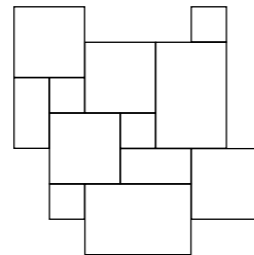

MODULO 3_3 FORMATI
 40,4x40,4 cm = 50%
 40,4x60,8 cm = 37,62%
 20x40,4 cm = 12,38%

Somnium PGZPSS3
 Fabula PGZPSF3
 Mirum PGZPSM3

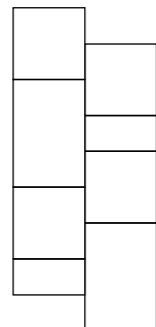

MODULO 4_3 FORMATI
 60,8x60,8 cm = 53,04%
 40,4x60,8 cm = 35,25%
 40,4x40,4 cm = 11,71%

Somnium PGZPSS4
 Fabula PGZPSF4
 Mirum PGZPSM4

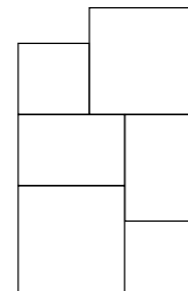

Esempio di sviluppo su superficie 4x4 mt_Example of extension on 4x4 mt surface_4x4 mt Entwicklungsbeispiel_Exemple de développement sur une surface de 4x4 M²

Petra Solis

PEZZI SPECIALI_TRIM PIECES

GRES A MASSA COLORATA_COLOURED-BODY STONEWARE

BATTISCOPA 10x60 cm Rect - 4"x24" ± 10 mm NATURALE	BATTISCOPA 10x60,3 cm - 4"x24" ± 10 mm NATURALE	ANGOLO GRADONE A COSTA RETTA 34x34 cm - 13 ^{3/8} "x13 ^{3/8} " ± 10 mm NATURALE	GRADONE A COSTA RETTA 30x34 cm - 12"x13 ^{3/8} " ± 10 mm NATURALE	ELEMENTO "L" 15x30x4 cm Rect - 6"x12"x1 ^{9/16} " ± 9 mm STRUTTURATO
SOMNIUM PGRPS11	PGRPS10	PGEPS11	PGEPS10	PGZPSA1
FABULA PGRPS01	PGRPS00	PGEPS01	PGEPS00	PGZPSA0
MIRUM PGRPS31	PGRPS30	PGEPS31	PGEPS30	PGZPSA3

BATTISCOPA SCALA DX (kit 2 pezzi) 10x45 cm - 4"x18" ± 10 mm NATURALE	BATTISCOPA SCALA SX (kit 2 pezzi) 10x45 cm - 4"x18" ± 10 mm NATURALE
SOMNIUM PGZPS1D	PGZPS1S
FABULA PGZPS0D	PGZPS0S
MIRUM PGZPS3D	PGZPS3S

GRES A MASSA COLORATA_COLOURED-BODY STONEWARE **20 mm**

COSTA TORO ANGOLARE DX 30x60 cm Rect - 12"x24" STRUTTURATO	COSTA TORO ANGOLARE SX 30x60 cm Rect - 12"x24" STRUTTURATO	COSTA TORO 30x60 cm Rect - 12"x24" STRUTTURATO	COSTA TORO GRIP 30x60 cm Rect - 12"x24" STRUTTURATO	COSTA RETTA ANGOLARE DX 30x60 cm Rect - 12"x24" STRUTTURATO	COSTA RETTA ANGOLARE SX 30x60 cm Rect - 12"x24" STRUTTURATO
SOMNIUM PGDPSK1	PGDPSK2	PGDPSF1	PGDPSJ1	PGDPSD1	PGDPSD2
MIRUM PGDPSK3	PGDPSK4	PGDPSF3	PGDPSJ3	PGDPSD3	PGDPSD4

COSTA RETTA 30x60 cm Rect - 12"x24" STRUTTURATO	COSTA RETTA GRIP 30x60 cm Rect - 12"x24" STRUTTURATO	GRIGLIA ANGOLARE DX 15x60 cm Rect - 6"x24" STRUTTURATO	GRIGLIA ANGOLARE SX 15x60 cm Rect - 6"x24" STRUTTURATO	GRIGLIA 15x60 cm Rect - 6"x24" STRUTTURATO
SOMNIUM PGDPSK1	PGDPSG1	PGDPSA1	PGDPSA2	PGDPSZ1
MIRUM PGDPSK3	PGDPSG3	PGDPSA3	PGDPSA4	PGDPSZ3

- Venduti solo a scatole complete_Only full boxes sold_Nur volle Karton_Vendus par boîte complete
- Lavorati solo su richiesta_Manufactured only upon special request_Nur auf Anfrage_Seulement à la demande
- Per tutti i pz speciali consegna 30 gg_For all trim pieces 30 days delivery_Formteile haben 30 Tage lieferzeit_Livraison en 30 jours pour toutes les pièces spéciales

IMBALLAGGI E PESI_PACKINGS AND WEIGHTS

DESCRIZIONE Description	± mm	FORMATI Sizes	SCATOLA_Box				PALLET		
FONDO NATURALE	10	60x60 ^{RECT}	4	32,30	1,44	-	32	1033,60	46,08
FONDO NATURALE	10	60,8x60,8	4	32,80	1,478	-	32	1049,60	47,32
FONDO NATURALE	10	40,4x60,8	5	28,80	1,228	-	48	1382,40	58,95
FONDO NATURALE	10	40,4x40,4	7	26,80	1,142	-	52	1393,60	59,41
FONDO NATURALE	10	20x40,4	12	22,80	0,969	-	54	1231,20	52,36
FONDO NATURALE	10	20x20	27	25,40	1,08	-	45	1143,00	48,60
FONDO STRUTTURATO	10	40,4x60,8	5	28,80	1,228	-	48	1382,40	58,95
BATTISCOPA NATURALE	10	10x60 ^{RECT}	12	15,48	0,72	7,20	60	928,80	43,20
BATTISCOPA NATURALE	10	10x60,3	16	20	0,964	9,648	48	960	46,31
BATTISCOPA SCALA NATURALE	10	10x45	5	8,5	0,400	-	-	-	-
GRADONE A COSTA RETTA NATURALE	10	30x34	6	18	0,612	-	30	540	18,36
ANGOLO GRADONE A COSTA RETTA NATURALE	10	34x34	2	6,60	0,231	-	48	316,80	11,10
ELEMENTO "L" STRUTTURATO	9	15x30xh4	8	9,60	0,36	2,40	48	460,80	17,28
FONDO STRUTTURATO	20	60x60 ^{RECT}	2	33,60	0,720	-	32	1075,2	23,04
COSTA TORO STRUTTURATO	20	30x60 ^{RECT}	1	8,125	0,180	-	100	812,5	18
COSTA TORO GRIP STRUTTURATO	20	30x60 ^{RECT}	1	8,125	0,180	-	100	812,5	18
COSTA TORO ANGOLARE STRUTTURATO	20	30x60 ^{RECT}	1	6,10	0,135	-	100	610	13,50
COSTA RETTA STRUTTURATO	20	30x60 ^{RECT}	1	8,125	0,180	-	100	812,5	18
COSTA RETTA GRIP STRUTTURATO	20	30x60 ^{RECT}	1	8,125	0,180	-	100	812,5	18
COSTA RETTA ANGOLARE STRUTTURATO	20	30x60 ^{RECT}	1	6,10	0,135	-	100	610	13,50
GRIGLIA STRUTTURATO	20	15x60 ^{RECT}	2	8	0,18	-	100	800	18
GRIGLIA ANGOLARE STRUTTURATO	20	15x60 ^{RECT}	2	7	0,157	-	100	700	15,75



Pierre des Rêves



REVEILLE



NUAGE



AURORE



CHARME



OUBLI

GRES A MASSA COLORATA_COLOURED-BODY STONEWARE



± 9,5 mm
± 12 mm



90x90 cm Rect
36"x36"



60x120 cm Rect
24"x48"



60x60 cm Rect
24"x24"



30x60 cm Rect
12"x24"



20x40,4 cm
8"x16"



20x30,2 cm
8"x12"



20x20 cm
8"x8"

GRES A MASSA COLORATA_COLOURED-BODY STONEWARE **20 mm**



± 20 mm



60x120 cm Rect
24"x48"



RIVESTIMENTO / WALL Muretto Charme Naturele 30x60 cm Rect - 12"x24"
PAVIMENTO / FLOOR Charme Naturele 90x90 cm Rect - 36"x36"_Charme Strutturato 60x120 cm Rect - 24"x48" 20 mm



PAVIMENTO / FLOOR Chevron Nuage Naturele 29,2x39 cm Rect - 11¹/₂"x15³/₈"



RIVESTIMENTO / WALL Muretto Oubli Naturele 30x60 cm Rect - 12"x24"
PAVIMENTO / FLOOR Oubli Naturele 60x120 cm Rect - 24"x48"_ Oubli Ext 60x60 cm Rect - 24"x24"



RIVESTIMENTO / WALL Reveille Naturelle 60x120 cm Rect - 24"x48" _Mosaico 16 pezzi Oubli Naturelle 30x30 cm Rect - 12"x12"
PAVIMENTO / FLOOR Reveille Naturelle 60x60 cm Rect - 24"x24"

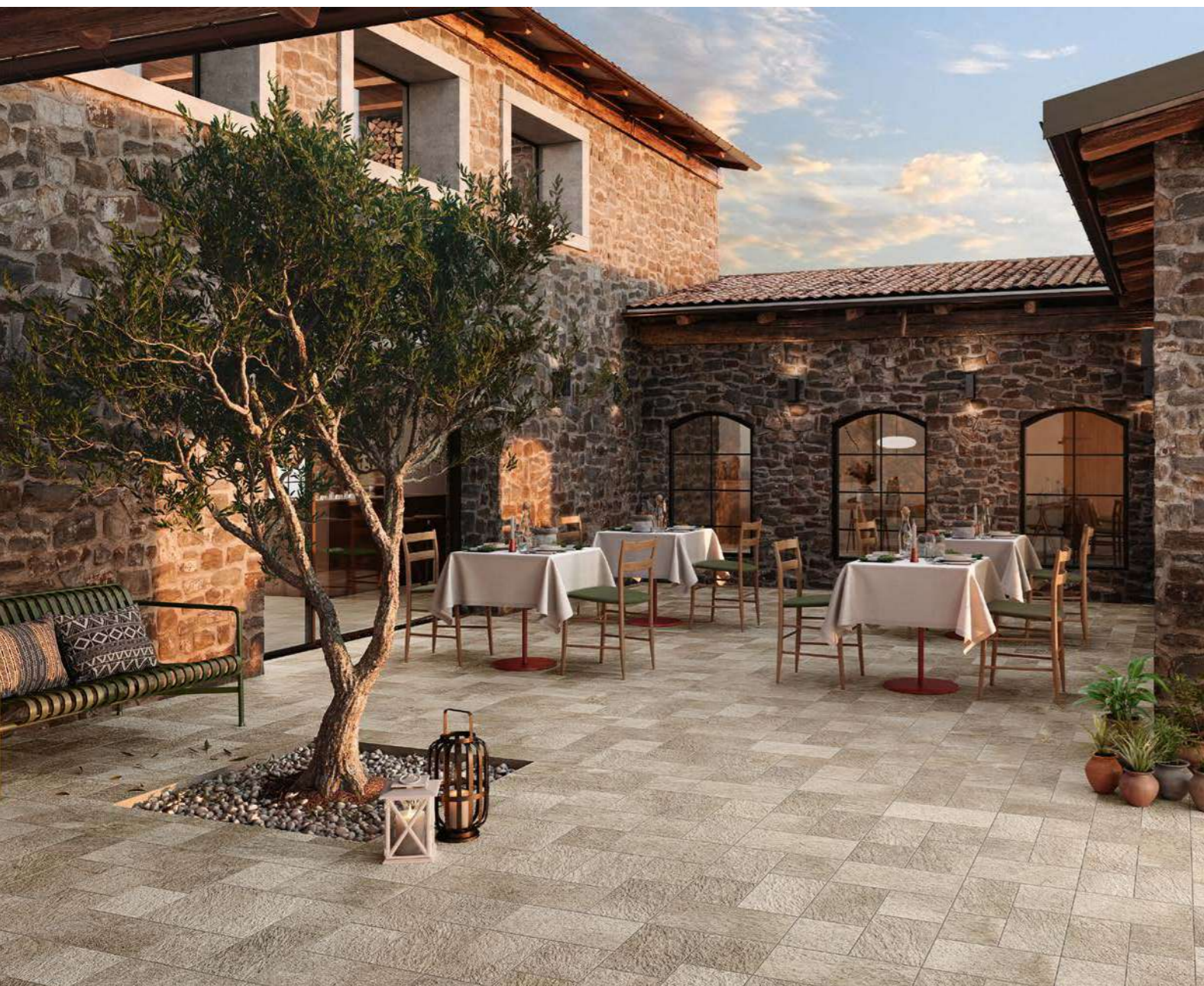

PAVIMENTO / FLOOR Aurore Strutturato 20x20 cm - 8"x8" _20x30,2 cm - 8"x12" _20x40,4 cm - 8"x16"

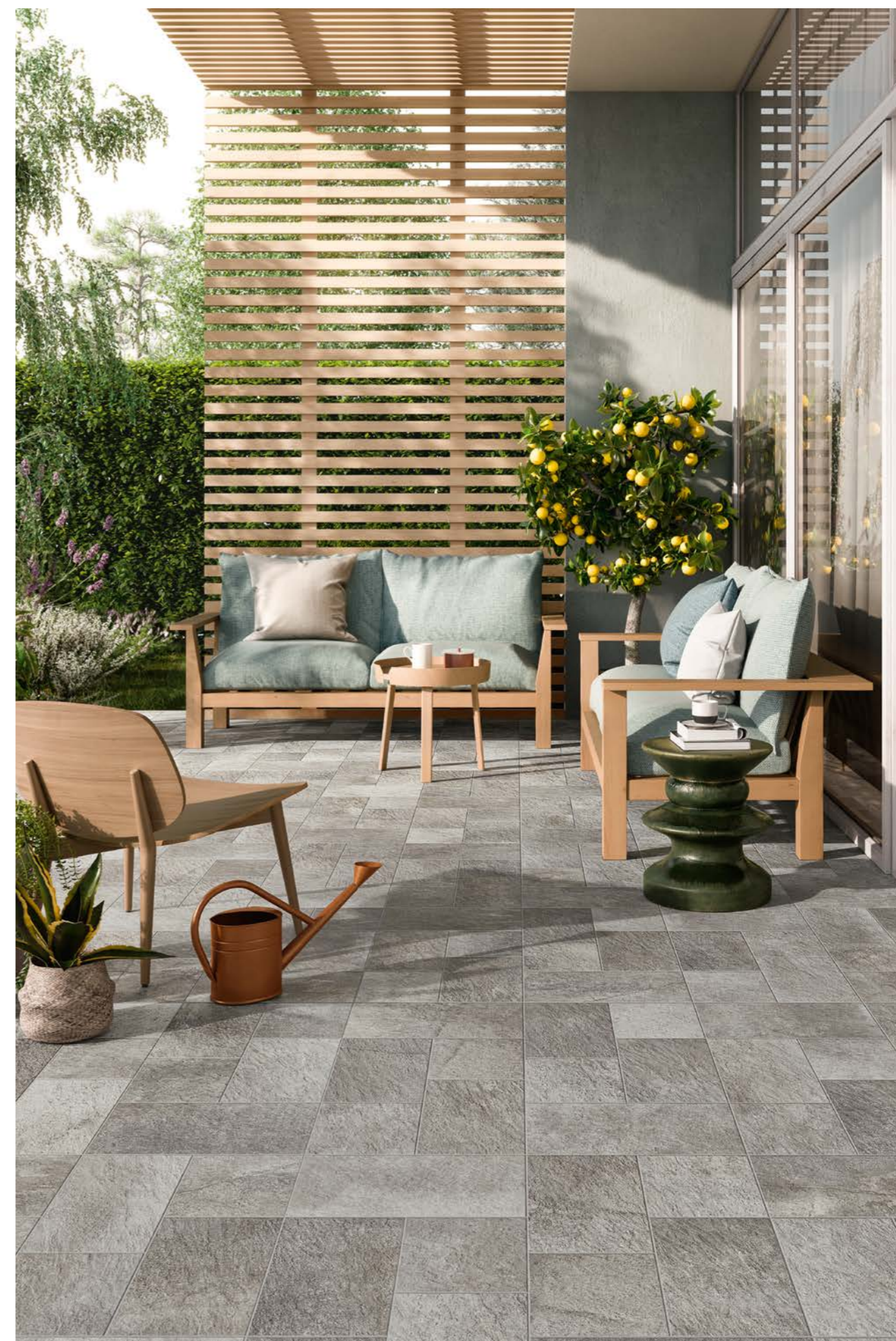

PAVIMENTO / FLOOR Nuage Strutturato 20x20 cm - 8"x8" _20x30,2 cm - 8"x12" _20x40,4 cm - 8"x16"

Pierre des Rêves

PROTECT
ANTIBATTERICO - ANTIMICROBIAL

REVEILLE



NUAGE



AURORE



CHARME



OUBLI



Pierre des Rêves

GRES A MASSA COLORATA_COLOURED-BODY STONEWARE



90x90 cm Rect - 36"x36"
Reveille NATURALE PGGP840
Nuage NATURALE PGGP810
Aurore NATURALE PGGP800
Charme NATURALE PGGP830
Oubli NATURALE PGGP820

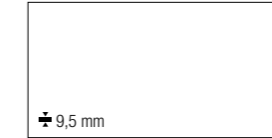

60x120 cm Rect - 24"x48"
Reveille NATURALE PGXP890
Nuage NATURALE PGXP860
Aurore NATURALE PGXP850
Charme NATURALE PGXP880
Oubli NATURALE PGXP870

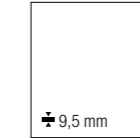

60x60 cm Rect - 24"x24"
Reveille NATURALE PGWP890
Nuage NATURALE PGWP860
Aurore NATURALE PGWP850
Charme NATURALE PGWP880
Oubli NATURALE PGWP870
Reveille EXT* PGWP840
Nuage EXT* PGWP810
Aurore EXT* PGWP800
Charme EXT* PGWP830
Oubli EXT* PGWP820

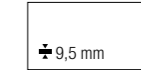

30x60 cm Rect - 12"x24"
Reveille NATURALE PG-P890
Nuage NATURALE PG-P860
Aurore NATURALE PG-P850
Charme NATURALE PG-P880
Oubli NATURALE PG-P870
Reveille EXT* PG-P840
Nuage EXT* PG-P810
Aurore EXT* PG-P800
Charme EXT* PG-P830
Oubli EXT* PG-P820



20x40,4 cm - 8"x16"
Nuage STRUTTURATO* PGKP810
Aurore STRUTTURATO* PGKP800
Oubli STRUTTURATO* PGKP820



20x30,2 cm - 8"x12"
Nuage STRUTTURATO* PGBP810
Aurore STRUTTURATO* PGBP800
Oubli STRUTTURATO* PGBP820



20x20 cm - 8"x8"
Nuage STRUTTURATO* PGEP810
Aurore STRUTTURATO* PGEP800
Oubli STRUTTURATO* PGEP820

GRES A MASSA COLORATA_COLOURED-BODY STONEWARE 20 mm

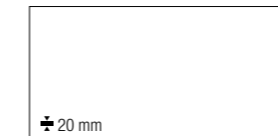

60x120 cm Rect - 24"x48"
Reveille STRUTTURATO* PGXP840
Nuage STRUTTURATO* PGXP810
Aurore STRUTTURATO* PGXP800
Charme STRUTTURATO* PGXP830
Oubli STRUTTURATO* PGXP820

DESTINAZIONI D'USO_INTENDED USE: NATURALE STRUTTURATO / EXT

DATI TECNICI_TECHNICAL DATA:

GRES A MASSA COLORATA COLOURED-BODY STONEWARE	GRES A MASSA COLORATA COLOURED-BODY STONEWARE
± 9,5 / 12 mm	20 mm
DIN 51130: R10 Naturale R11 Ext R12 Strutturato DIN 51097: A Naturale C (A+B+C) Ext, Strutturato BCR TORTUS: μ > 0,40 ANSI A326.3: DCOF ≥ 0.42 AS/NZS 4586: P4 Ext, Strutturato BS 7976-2: PTV 36+WET (SL.96 - SL.55) Ext, Strutturato	DIN 51130: R12 DIN 51097: C (A+B+C) BCR TORTUS: μ > 0,40 ANSI A326.3: DCOF ≥ 0.42 AS/NZS 4586: P4 BS 7976-2: PTV 36+WET (SL.96 - SL.55)
ANSI A137.1: V4	ANSI A137.1: V4

PROTECT
ANTIBATTERICO - ANTIMICROBIAL

SOLUZIONI DI POSA OUTDOOR_OUTDOOR LAYING SOLUTIONS 12 mm

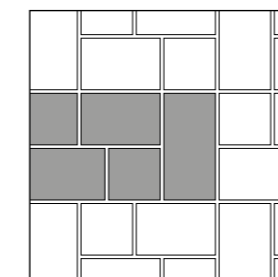

20x40,4 (28,69%) - 20x30,2 (42,90%) - 20x20 (28,41%)

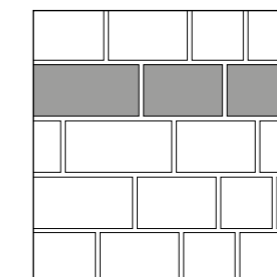

20x40,4 (44,59%) - 20x30,2 (33,33%) - 20x20 (22,08%)

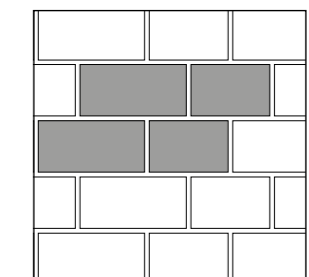

20x30,2 (42,78%) - 20x40,4 (57,22%)

* Protezione antibatterica non presente_No antimicrobial protectio_Der Antibakterielle Schutz nicht vorhanden_Protection antibactérienne pas présente

Pierre des Rêves

DECORI_DECORS

GRES A MASSA COLORATA_COLOURED-BODY STONEWARE

REVEILLE MURETTO NATURALE 30x60 cm Rect - 12"x24" ± 9,5 mm PGZP8M4	NUAGE MURETTO NATURALE 30x60 cm Rect - 12"x24" ± 9,5 mm PGZP8M1	AURORE MURETTO NATURALE 30x60 cm Rect - 12"x24" ± 9,5 mm PGZP8M0	CHARME MURETTO NATURALE 30x60 cm Rect - 12"x24" ± 9,5 mm PGZP8M3	OUBLI MURETTO NATURALE 30x60 cm Rect - 12"x24" ± 9,5 mm PGZP8M2
 CHEVRON NATURALE 29,2x39 cm Rect - 11 1/2"x15 3/8" ± 9,5 mm PGZP8C4	 CHEVRON NATURALE 29,2x39 cm Rect - 11 1/2"x15 3/8" ± 9,5 mm PGZP8C1	 CHEVRON NATURALE 29,2x39 cm Rect - 11 1/2"x15 3/8" ± 9,5 mm PGZP8C0	 CHEVRON NATURALE 29,2x39 cm Rect - 11 1/2"x15 3/8" ± 9,5 mm PGZP8C3	 CHEVRON NATURALE 29,2x39 cm Rect - 11 1/2"x15 3/8" ± 9,5 mm PGZP8C2
 MOSAICO 16 PEZZI NATURALE 30x30 cm Rect - 12"x12" ± 9,5 mm PGZP890	 MOSAICO 16 PEZZI NATURALE 30x30 cm Rect - 12"x12" ± 9,5 mm PGZP860	 MOSAICO 16 PEZZI NATURALE 30x30 cm Rect - 12"x12" ± 9,5 mm PGZP850	 MOSAICO 16 PEZZI NATURALE 30x30 cm Rect - 12"x12" ± 9,5 mm PGZP880	 MOSAICO 16 PEZZI NATURALE 30x30 cm Rect - 12"x12" ± 9,5 mm PGZP870
	 TABLEAU 60x120 cm Rect - 24"x48" ± 9,5 mm PGXP8T1	 TABLEAU 60x120 cm Rect - 24"x48" ± 9,5 mm PGXP8T0	 TABLEAU 60x120 cm Rect - 24"x48" ± 9,5 mm PGXP8T3	 TABLEAU 60x120 cm Rect - 24"x48" ± 9,5 mm PGXP8T2

TABLEAU:
Decoro sviluppato su 2 soggetti diversi venduti insieme. Decoration developed on 2 different patterns sold together. Dekor zu 2 verschiedenen Themen entwickelt, die zusammen verkauft werden. Décor développé sur 2 sujets différents vendus ensemble.

CHEVRON:
Questi formati speciali vengono realizzati con un sistema di taglio a disco senza bisello. L'eventuale presenza di leggere irregolarità del bordo e di scostamenti dimensionali fino ad 1 mm sono da ritenersi conformi. These special formats are produced with a disc cutting system without a bevel. Any slight irregularities of the edge and size deviations of up to 1 mm should be regarded as compliant. Diese Sonderformate werden mit einem Scheibenschnittsystem ohne Fase hergestellt. Eventuelle leichte Unregelmäßigkeiten an der Kante und Größenabweichungen bis zu 1 mm sind als konform anzusehen. Ces formats spéciaux sont réalisés avec un système de découpe à disque sans biseau. L'eventuelle présence de légères irrégularités du bord et de différences de dimension jusqu'à 1 mm est tout à fait conforme.

TABLEAU, MURETTO, CHEVRON, MOSAICO 16 PEZZI:
Possibilità di utilizzo a pavimento in interni. Suitable for interiors floor. Möglichkeit der Verwendung als Boden in Innenbereichen. Possibilité d'utilisation pour les sols à l'intérieur.

PEZZI SPECIALI_TRIM PIECES

GRES A MASSA COLORATA_COLOURED-BODY STONEWARE

 BATTISCOPIA 7,5x60 cm Rect - 3"x24" ± 10 mm NATURALE	 GRADONE A COSTA RETTA 30x34 cm Rect - 12"x13 3/8" ± 9,5 mm NATURALE	 ANGOLO GRADONE A COSTA RETTA 34x34 cm Rect - 13 3/8"x13 3/8" ± 9,5 mm NATURALE
REVEILLE PGRP840	PGEP840	PGEP840
NUAGE PGRP810	PGEP810	PGEP811
AURORE PGRP800	PGEP800	PGEP801
CHARME PGRP830	PGEP830	PGEP831
OUBLI PGRP820	PGEP820	PGEP820

Pierre des Rêves

PEZZI SPECIALI_TRIM PIECES

GRES A MASSA COLORATA_COLOURED-BODY STONEWARE

 BATTISCOPIA SCALA DX (kit 2 pezzi) 10x45 cm - 4"x18" ± 10 mm NATURALE	 BATTISCOPIA SCALA SX (kit 2 pezzi) 10x45 cm - 4"x18" ± 10 mm NATURALE	 ELEMENTO "L" MONOBLOCCO 15x30x4 cm - 6"x12"x1 9/16" ± 12 mm STRUTTURATO*	 ELEMENTO "L" 15x30x4 cm Rect - 6"x12"x1 9/16" ± 9,5 mm EXT*
REVEILLE PGZP84D	PGZP84S	/	PGZP8L4
NUAGE PGZP81D	PGZP81S	PGZP810	PGZP8L1
AURORE PGZP80D	PGZP80S	PGZP800	PGZP8L0
CHARME PGZP83D	PGZP83S	/	PGZP8L3
OUBLI PGZP82D	PGZP82S	PGZP8L2	PGZP8L2

ELEMENTO "L" MONOBLOCCO:
Abbinabile alla finitura Strutturato. To be used with Strutturato version. Kombinierbar mit Finish Strutturato. Combinable à la finition Strutturato.

ELEMENTO "L":
Realizzato tramite incollaggio. Made by gluing. Hergestellt durch Kleben. Réalisé par collage.
Abbinabile alla finitura Ext. To be used with Ext version. Kombinierbar mit Finish Ext. Combinable à la finition Ext.

GRES A MASSA COLORATA_COLOURED-BODY STONEWARE 20 mm

 COSTA TORO ANGOLARE DX 30x60 cm Rect - 12"x24" STRUTTURATO*	 COSTA TORO ANGOLARE SX 30x60 cm Rect - 12"x24" STRUTTURATO*	 COSTA TORO 30x60 cm Rect - 12"x24" STRUTTURATO*	 COSTA TORO GRIP 30x60 cm Rect - 12"x24" STRUTTURATO*	 COSTA RETTA ANGOLARE DX 30x60 cm Rect - 12"x24" STRUTTURATO*	 COSTA RETTA ANGOLARE SX 30x60 cm Rect - 12"x24" STRUTTURATO*
REVEILLE PGDP8K8	PGDP8K9	PGDP8F4	PGDP8J4	PGDP8D8	PGDP8D9
NUAGE PGDP8K2	PGDP8K3	PGDP8F1	PGDP8J1	PGDP8D2	PGDP8D3
AURORE PGDP8K0	PGDP8K1	PGDP8F0	PGDP8J0	PGDP8D0	PGDP8D1
CHARME PGDP8K6	PGDP8K7	PGDP8F3	PGDP8J3	PGDP8D6	PGDP8D7
OUBLI PGDP8K4	PGDP8K5	PGDP8F2	PGDP8J2	PGDP8D4	PGDP8D5

 COSTA RETTA 30x60 cm Rect - 12"x24" STRUTTURATO*	 COSTA RETTA GRIP 30x60 cm Rect - 12"x24" STRUTTURATO*	 GRIGLIA ANGOLARE DX 15x60 cm Rect - 6"x24" STRUTTURATO*	 GRIGLIA ANGOLARE SX 15x60 cm Rect - 6"x24" STRUTTURATO*	 GRIGLIA 15x60 cm Rect - 6"x24" STRUTTURATO*
REVEILLE PGDP8C4	PGDP8G4	PG1P8A8	PG1P8A9	PGDP8Z4
NUAGE PGDP8C0	PGDP8G1	PG1P8A2	PG1P8A3	PGDP8Z1
AURORE PGDP8C1	PGDP8G0	PG1P8A0	PG1P8A1	PGDP8Z0
CHARME PGDP8C3	PGDP8G3	PG1P8A6	PG1P8A7	PGDP8Z3
OUBLI PGDP8C2	PGDP8G2	PG1P8A4	PG1P8A5	PGDP8Z2

PEZZI SPECIALI 20 mm: venduti solo a scatole complete, lavorati solo su richiesta, consegna 30 gg. TRIM PIECES 20 mm: only full boxes sold, manufactured only upon special request, 30 days delivery. SPEZIALTEILE 20 mm: nur als komplette Kartons verkauft, nur auf Anfrage verarbeitet, Lieferzeit 30 Tage. PIECES SPECIALES 20 mm vendus uniquement par boîte complète, produits uniquement à la demande, livraison 30 jours.

* Protezione antibatterica non presente. No antimicrobial protection. Der Antibakterielle Schutz nicht vorhanden. Protection antibactérienne pas présente.

IMBALLAGGI E PESI_PACKINGS AND WEIGHTS

DESCRIZIONE Description	± mm	FORMATI Sizes	SCATOLA_Box				PALLET		
			📦	📦	📏	📏	📦	📏	📏
FONDO NATURALE	9,5	60x120 ^{RECT}	2	31,8	1,44	-	36	1145	51,8
FONDO NATURALE	9,5	90x90 ^{RECT}	2	34,6	1,62	-	25	865	40,5
FONDO NATURALE / EXT	9,5	60x60 ^{RECT}	4	31,8	1,44	-	32	1018	46,1
FONDO NATURALE / EXT	9,5	30x60 ^{RECT}	8	31,8	1,44	-	32	1018	46,1
FONDO STRUTTURATO	12	20x40,4	10	21	0,808	-	54	1134,0	43,632
FONDO STRUTTURATO	12	20x30,2	15	23,1	0,906	-	48	1108,8	43,488
FONDO STRUTTURATO	12	20x20	22	22,2	0,880	-	45	999,0	39,60
FONDO STRUTTURATO	20	60x120 ^{RECT}	1	32,5	0,72	-	32	1.040,0	23,04
TABLEAU	9,5	60x120 ^{RECT}	2	31,8	1,44	-	15	477	21,6
CHEVRON NATURALE	9,5	29,2x39 ^{RECT}	7	16,3	0,797	-	32	523	25,5
MURETTO NATURALE	9,5	30x60 ^{RECT}	4	15,7	0,72	-	30	471	21,6
MOSAICO 16 pezzi NATURALE	9,5	30x30 ^{RECT}	4	7,2	0,36	-	78	562	28,1
BATTISCOPIA NATURALE	10	7,5x60 ^{RECT}	12	11,61	0,54	7,20	64	743,04	34,56
BATTISCOPIA SCALA KIT (2 PZ.) NATURALE	10	7,5x45	5	7,5	0,337	-	-	-	-
GRADONE A COSTA RETTA NATURALE	9,5	30x34 ^{RECT}	6	20	0,612	-	30	599	18,4
ANGOLO GRADONE A COSTA RETTA NATURALE	9,5	34x34 ^{RECT}	2	6,3	0,231	-	48	301	11,1
ELEMENTO "L" EXT	9,5	15x30x4 ^{RECT}	8	8,7	0,36	2,40	48	420	17,3
ELEMENTO "L" MONOBLOCCO STRUTTURATO	12	15x30x4 ^{RECT}	8	12	0,36	2,40	44	105,6	15,84
COSTA TORO STRUTTURATO	20	30x60 ^{RECT}	1	8,125	0,18	-	100	812,5	18,00
ANGOLO COSTA TORO STRUTTURATO	20	30x60 ^{RECT}	1	6,1	0,136	-	100	610,0	13,50
COSTA TORO GRIP STRUTTURATO	20	30x60 ^{RECT}	1	8,125	0,18	-	100	812,5	18,00
COSTA RETTA STRUTTURATO	20	30x60 ^{RECT}	1	8,125	0,18	-	100	812,5	18,00
ANGOLO COSTA RETTA STRUTTURATO	20	30x60 ^{RECT}	1	6,1	0,136	-	100	610,0	13,50
COSTA RETTA GRIP STRUTTURATO	20	30x60 ^{RECT}	1	8,125	0,18	-	100	812,5	18,00
GRIGLIA STRUTTURATO	20	15x60 ^{RECT}	2	8	0,18	-	100	800,0	18,00
ANGOLO GRIGLIA STRUTTURATO	20	15x60 ^{RECT}	2	7	0,157	-	100	700,0	15,75



Pietre di Fanes



GRIGIO MISTO



ROSSO MISTO

GRES TUTTA MASSA_FULL-BODY STONEWARE



± 9 mm

20x41 cm
8"x16"^{1/8}"

20x30,5 cm
8"x12"

20x20 cm
8"x8"



PAVIMENTO / FLOOR Grigio Misto 20x20 cm - 8"x8" _Grigio Misto coda di pavone maxi 138x87,5x26,5 cm - 54"x34 1/2"x10 1/2"

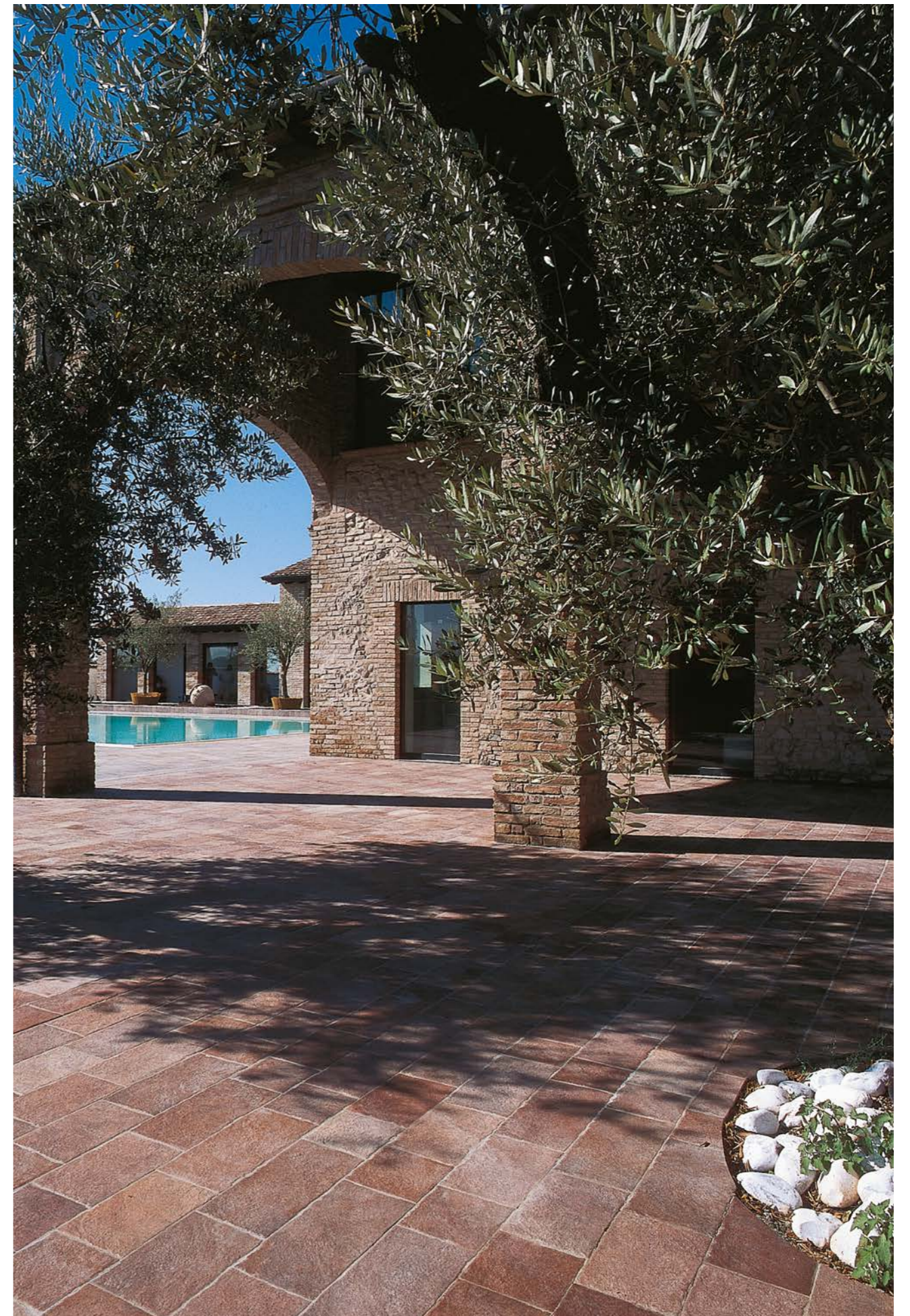

PAVIMENTO / FLOOR Rosso Misto 20x20 cm - 8"x8" _Rosso Misto 20x30,5 cm - 8"x12" _Rosso Misto 20x41 cm - 8"x16 1/8"

Pietre di Fanes



GRIGIO MISTO



ROSSO MISTO



GRES TUTTA MASSA_FULL-BODY STONEWARE

 9 mm	 9 mm	 9 mm
20x41 cm - 8"x16"^{1/8"}	20x30,5 cm - 8"x12"	20x20 cm - 8"x8"
Grigio Misto STRUTTURATO PGKP705 Rosso Misto STRUTTURATO PGKP715	Grigio Misto STRUTTURATO PGBP705 Rosso Misto STRUTTURATO PGBP715	Grigio Misto STRUTTURATO PGE705 Rosso Misto STRUTTURATO PGE715

SOLUZIONI DI POSA_LAYING SOLUTIONS

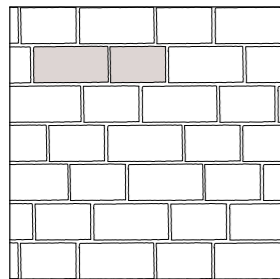

20x30,5 (42,66%) - 20x41 (57,34%)

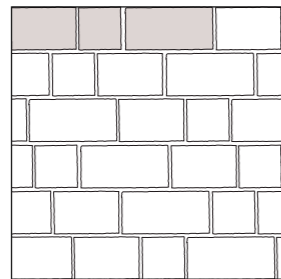

20x20 (21,86%) - 20x30,5 (33,33%)
20x41 (44,81%)

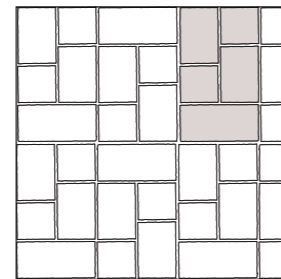









20x20 (28,17%) - 20x30,5 (42,96%)
20x41 (28,87%)

Fuga consigliata: vedi pag. 381_Suggested joint: see pag. 381_Empfohlene Fuge: siehe Seite 381_Joint conseillé : voir page 381

DESTINAZIONI D'USO_INTENDED USE: STRUTTURATO 

DATI TECNICI_TECHNICAL DATA:

GRES TUTTA MASSA FULL-BODY STONEWARE	
9 mm	
 DIN 51130: R11	 DIN 51097: C (A+B+C)
 BCR TORTUS: $\mu > 0,40$	 ANSI A326.3: DCOF $\geq 0,42$
 EN 101: MOHS 9	 CTI 81-7 ANNEX A: MOHS 9
 ANSI A137.1: V4	
	

Pietre di Fanes

PEZZI SPECIALI_TRIM PIECES

GRES A MASSA COLORATA_COLOURED-BODY STONEWARE

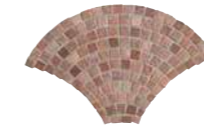

CODA DI PAVONE MAXI (MQ. 0,67)
(KIT 4 PZ.)
138x87,5x26,5 cm - 54"x34^{1/2"} x10^{1/2"}
9 mm



CODA DI PAVONE (MQ. 0,40)
(KIT 4 PZ.)
103x65x19 cm - 40^{1/2"}x25^{1/2"} x7^{1/2"}
9 mm

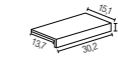

ELEMENTO "L"
15x30x4 cm Rect - 6"x12"x1^{9/16"}
9 mm

	STRUTTURATO	STRUTTURATO	STRUTTURATO
GRIGIO MISTO	PGZP709	PGZP705	PGZP7A0
ROSSO MISTO	PGZP719	PGZP715	PGZP7A1

1 Modulo Module / Modul / Module

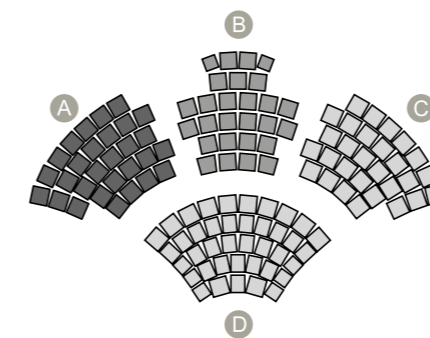

2 Montaggio Assembly / Versammlung / Montage

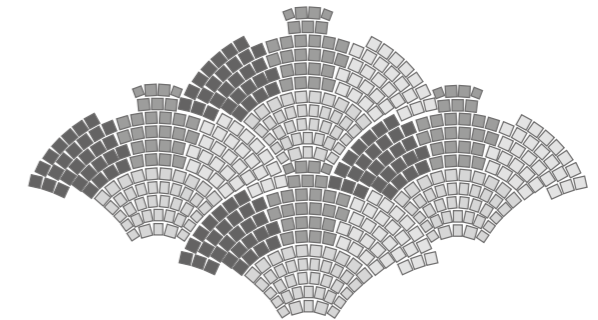



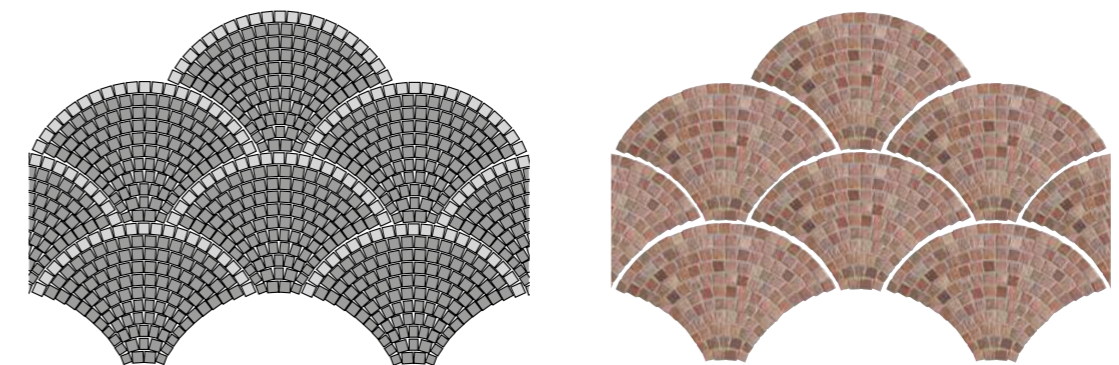



3 Risultato finale Final Result / Endergebnis / Résultat Final



Trattandosi di pezzi artigianali possono verificarsi piccole variazioni dimensionali_Handmade pieces: light size variations may occur_Da es sich um handgemachte Teile handelt, können es kleine dimensionale Veränderungen auftreten_Étant donné qu'il s'agit de pièces faites à la main il peut y avoir des petits changements dimensionnels

IMBALLAGGI E PESI_PACKINGS AND WEIGHTS

DESCRIZIONE Description	9 mm	FORMATI Sizes	SCATOLA_Box				PALLET			
										
FONDO STRUTTURATO	9	20x20	30	25	1,200	-	45	1125	54	
FONDO STRUTTURATO	9	20x30,5	20	23,10	1,220	-	48	1108,80	58,560	
FONDO STRUTTURATO	9	20x41	19	30,7	1,558	-	36	1105,20	56,088	
CODA DI PAVONE MAXI STRUTTURATO	9	MODULO 4 PZ.	1	9,8	0,670	-	44	431,20	29,480	
CODA DI PAVONE STRUTTURATO	9	MODULO 4 PZ.	1	7	0,400	-	40	280	16	
ELEMENTO "L" STRUTTURATO	9	15x30x4	8	9,6	0,360	2,40	48	460,80	17,280	



RIVESTIMENTO / WALL **Black Prime Soft 100x300 cm Rect - 39"x118"**
 PAVIMENTO / FLOOR **Silver Prime Soft 100x250 cm Rect - 39"x98^{1/2}"**

Prime Stone



WHITE PRIME



SILVER PRIME

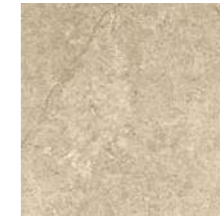

SAND PRIME



GREIGE PRIME



BLACK PRIME

GRES PORCELLANATO LAMINATO / LAMINATED PORCELAIN STONEWARE **Zero.3**



± 5,5 mm



100x300 cm Rect
39"x118"



100x250 cm Rect
39"x98^{1/2}"



100x100 cm Rect
39"x39"



50x100 cm Rect
19^{1/2}"x39"

RIVESTIMENTO MONOPOROSA / SINGLE-FIRED WALL TILES



± 9 mm



20x60 cm Rect
8"x24"

GRES A MASSA COLORATA / COLOURED-BODY STONEWARE



± 9,5 mm



90x90 cm Rect
36"x36"



45x90 cm Rect
18"x36"



60x60 cm Rect
24"x24"
60,3x60,3 cm
24"x24"



30x60 cm Rect
12"x24"

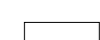

20x60 cm Rect
8"x24"

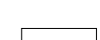

15x60 cm Rect
6"x24"

GRES A MASSA COLORATA / COLOURED-BODY STONEWARE **20 mm**



± 20 mm



45x90 cm Rect
18"x36"



RIVESTIMENTO / WALL Sand Prime Soft 20x60 cm Rect - 8"x24" _ Sand Prime Square 20x60 cm Rect - 8"x24"
PAVIMENTO / FLOOR Sand Prime Soft 90x90 cm Rect - 36"x36"



RIVESTIMENTO / WALL Silver Prime Muretto 30x60 cm Rect - 12"x24"
PAVIMENTO / FLOOR Black Prime Soft 45x90 cm Rect - 18"x36"



RIVESTIMENTO / WALL Black Prime Muretto 30x60 cm - 12"x24"
PAVIMENTO / FLOOR White Prime Lux 90x90 cm - 36"x36"



RIVESTIMENTO / WALL White Prime Soft 100x300 cm Rect - 39"x118" _Black Prime Soft 100x300 cm Rect - 39"x118" _Black Prime Soft 50x100 cm Rect - 19 1/2"x39"
 PAVIMENTO / FLOOR White Prime Soft 100x100 cm Rect - 39"x39"



RIVESTIMENTO / WALL Greige Prime Soft 100x300 cm Rect - 39"x118"
 PAVIMENTO / FLOOR Greige Prime Soft 100x100 cm Rect - 39"x118"



PAVIMENTO / FLOOR Greige Prime Strutturato 45x90 cm Rect - 18"x36" 20mm

Prime Stone

PR()TECT
ANTIBATTERICO - ANTIMICROBIAL

WHITE PRIME



SILVER PRIME



SAND PRIME



GREIGE PRIME



BLACK PRIME



DESTINAZIONI D'USO_INTENDED USE: SOFT LUX STRUTTURATO

DATI TECNICI_TECHNICAL DATA:

GRES PORCELLANATO LAMINATO LAMINATED PORCELAIN STONEWARE	RIVESTIMENTO MONOPOROSA SINGLE-FIRED WALL TILES	GRES A MASSA COLORATA COLOURED-BODY STONEWARE	GRES A MASSA COLORATA COLOURED-BODY STONEWARE
5,5 mm	9 mm	9,5 mm	20 mm
DIN 51130: R9 BCR TORTUS: $\mu > 0,40$ ANSI A326.3: DCOF $\geq 0,42$	/	DIN 51130: R9 Soft R11 Strutturato DIN 51097: C (A+B+C) Strutturato BCR TORTUS: $\mu > 0,40$ ANSI A326.3: DCOF $\geq 0,42$ AS/NZS 4586: P4 Strutturato BS 7976-2: PTV 36+WET (SI.96 - SI.55) Strutturato	DIN 51130: R11 DIN 51097: C (A+B+C) BCR TORTUS: $\mu > 0,40$ ANSI A326.3: DCOF $\geq 0,42$ AS/NZS 4586: P4 BS 7976-2: PTV 36+WET (SI.96 - SI.55)
ANSI A137.3: V2	ANSI A137.1: V1	ANSI A137.1: V2	ANSI A137.1: V2
PR()TECT ANTIBATTERICO - ANTIMICROBIAL	PR()TECT ANTIBATTERICO - ANTIMICROBIAL	PR()TECT ANTIBATTERICO - ANTIMICROBIAL	PR()TECT ANTIBATTERICO - ANTIMICROBIAL

Prime Stone

GRES PORCELLANATO LAMINATO_LAMINATED PORCELAIN STONEWARE **Zero.3**



100x300 cm Rect - 39"x118"

White Prime SOFT PZ7PM00
Silver Prime SOFT PZ7PM20
Sand Prime SOFT PZ7PM40
Greige Prime SOFT PZ7PM30
Black Prime SOFT PZ7PM10



100x250 cm Rect - 39"x98 1/2"

White Prime SOFT PZ6PM00
Silver Prime SOFT PZ6PM20
Sand Prime SOFT PZ6PM40
Greige Prime SOFT PZ6PM30
Black Prime SOFT PZ6PM10

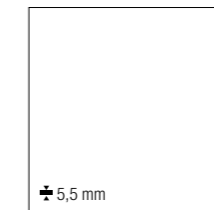

100x100 cm Rect - 39"x39"

White Prime SOFT PZ8PM00
Silver Prime SOFT PZ8PM20
Sand Prime SOFT PZ8PM40
Greige Prime SOFT PZ8PM30
Black Prime SOFT PZ8PM10



50x100 cm Rect - 19 1/2"x39"

White Prime SOFT PZ9PM00
Silver Prime SOFT PZ9PM20
Sand Prime SOFT PZ9PM40
Greige Prime SOFT PZ9PM30
Black Prime SOFT PZ9PM10

GRES A MASSA COLORATA_COLOURED-BODY STONEWARE

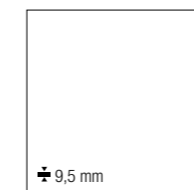

90x90 cm Rect - 36"x36"

White Prime SOFT PGGPM002
Silver Prime SOFT PGGPM202
Sand Prime SOFT PGGPM402
Greige Prime SOFT PGGPM302
Black Prime SOFT PGGPM102
White Prime LUX PGGPML02
Silver Prime LUX PGGPML22
Sand Prime LUX PGGPML42
Greige Prime LUX PGGPML32
Black Prime LUX PGGPML12



45x90 cm Rect - 18"x36"

White Prime SOFT PGHPMN0
Silver Prime SOFT PGHPMN2
Sand Prime SOFT PGHPMN4
Greige Prime SOFT PGHPMN3
Black Prime SOFT PGHPMN1
White Prime LUX PGHPML0
Silver Prime LUX PGHPML2
Sand Prime LUX PGHPML4
Greige Prime LUX PGHPML3
Black Prime LUX PGHPML1

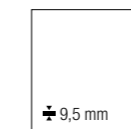

60x60 cm Rect - 24"x24"

White Prime SOFT PGWPM00
Silver Prime SOFT PGWPM20
Sand Prime SOFT PGWPM40
Greige Prime SOFT PGWPM30
Black Prime SOFT PGWPM10
White Prime LUX PGWPLM0
Silver Prime LUX PGWPLM2
Sand Prime LUX PGWPLM4
Greige Prime LUX PGWPLM3
Black Prime LUX PGWPLM1

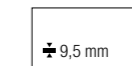

30x60 cm Rect - 12"x24"

White Prime SOFT PG-PM00
Silver Prime SOFT PG-PM20
Sand Prime SOFT PG-PM40
Greige Prime SOFT PG-PM30
Black Prime SOFT PG-PM10
Silver Prime STRUTTURATO* PG-PMS2
Sand Prime STRUTTURATO* PG-PMS4

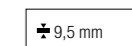

20x60 cm Rect - 8"x24"

Silver Prime STRUTTURATO* PG2PMS2
Sand Prime STRUTTURATO* PG2PMS4

15x60 cm Rect - 6"x24"

Silver Prime STRUTTURATO* PG1PMS2
Sand Prime STRUTTURATO* PG1PMS4

60,3x60,3 cm Rect - 24"x24"
Silver Prime STRUTTURATO* PGWPM2
Sand Prime STRUTTURATO* PGWPM4

RIVESTIMENTO MONOPOROSA_SINGLE-FIRED WALL TILES



20x60 cm Rect - 8"x24"

White Prime PB2PM001
Silver Prime PB2PM201
Sand Prime PB2PM401
Greige Prime PB2PM301
Black Prime PB2PM101

GRES A MASSA COLORATA_COLOURED-BODY STONEWARE **20 mm**



45x90 cm Rect - 18"x36"

Silver Prime STRUTTURATO* PGHPM21
Sand Prime STRUTTURATO* PGHPM41
Greige Prime STRUTTURATO* PGHPM31
Black Prime STRUTTURATO* PGHPM11

* Protezione antibatterica non presente_No antimicrobial protectio_Der Antibakterielle Schutz nicht vorhanden_Protection antibactérienne pas présente

Prime Stone

DECORI_DECORS**

GRES A MASSA COLORATA_COLOURED-BODY STONEWARE

WHITE PRIME

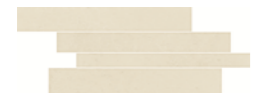

MURETTO
30x60 cm Rect - 12"x24"
± 9,5 mm

PG-PMM0

SILVER PRIME



MURETTO
30x60 cm Rect - 12"x24"
± 9,5 mm

PG-PMM2

SAND PRIME

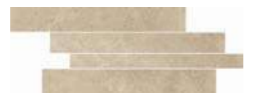

MURETTO
30x60 cm Rect - 12"x24"
± 9,5 mm

PG-PMM4

GREIGE PRIME



MURETTO
30x60 cm Rect - 12"x24"
± 9,5 mm

PG-PMM3

BLACK PRIME



MURETTO
30x60 cm Rect - 12"x24"
± 9,5 mm

PG-PMM1



MOSAICO 16 PEZZI
30x30 cm Rect - 12"x12"
± 9,5 mm

PGZPM00



MOSAICO 16 PEZZI
30x30 cm Rect - 12"x12"
± 9,5 mm

PGZPM20



MOSAICO 16 PEZZI
30x30 cm Rect - 12"x12"
± 9,5 mm

PGZPM40



MOSAICO 16 PEZZI
30x30 cm Rect - 12"x12"
± 9,5 mm

PGZPM30



MOSAICO 16 PEZZI
30x30 cm Rect - 12"x12"
± 9,5 mm

PGZPM10

RIVESTIMENTO MONOPOROSA_SINGLE-FIRED WALL TILES

WHITE PRIME



PREINCISO
20x60 cm Rect - 8"x24"
± 9 mm

PB2PM05

SILVER PRIME



PREINCISO
20x60 cm Rect - 8"x24"
± 9 mm

PB2PM25

SAND PRIME



PREINCISO
20x60 cm Rect - 8"x24"
± 9 mm

PB2PM45

GREIGE PRIME



PREINCISO
20x60 cm Rect - 8"x24"
± 9 mm

PB2PM35

BLACK PRIME



PREINCISO
20x60 cm Rect - 8"x24"
± 9 mm

PB2PM15



STREAM
20x60 cm Rect - 8"x24"
± 9 mm

PB2PMS0

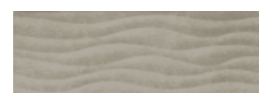

STREAM
20x60 cm Rect - 8"x24"
± 9 mm

PB2PMS2



STREAM
20x60 cm Rect - 8"x24"
± 9 mm

PB2PMS4



STREAM
20x60 cm Rect - 8"x24"
± 9 mm

PB2PMS3



STREAM
20x60 cm Rect - 8"x24"
± 9 mm

PB2PMS1



SQUARE
20x60 cm Rect - 8"x24"
± 9 mm

PB2PMQ0



SQUARE
20x60 cm Rect - 8"x24"
± 9 mm

PB2PMQ2



SQUARE
20x60 cm Rect - 8"x24"
± 9 mm

PB2PMQ4



SQUARE
20x60 cm Rect - 8"x24"
± 9 mm

PB2PMQ3



SQUARE
20x60 cm Rect - 8"x24"
± 9 mm

PB2PMQ1

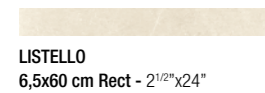

LISTELLO
6,5x60 cm Rect - 2 1/2"x24"
± 9 mm

PBOPM00

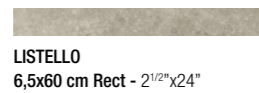

LISTELLO
6,5x60 cm Rect - 2 1/2"x24"
± 9 mm

PBOPM20

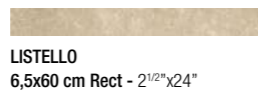

LISTELLO
6,5x60 cm Rect - 2 1/2"x24"
± 9 mm

PBOPM40



LISTELLO
6,5x60 cm Rect - 2 1/2"x24"
± 9 mm

PBOPM30



LISTELLO
6,5x60 cm Rect - 2 1/2"x24"
± 9 mm

PBOPM10

** Disponibili nella superficie Soft_Soft finishes available_Erhältlich in der Oberfläche Soft_Disponibles dans la surface Soft

Prime Stone

PEZZI SPECIALI_TRIM PIECES

GRES A MASSA COLORATA_COLOURED-BODY STONEWARE

	BATTISCOPA 10x60 cm Rect - 4"x24" ± 10 mm SOFT	LUX	ANGOLO GRADONE A COSTA RETTA 34x34 cm Rect - 13 ^{3/8} "x13 ^{3/8} " ± 9,5 mm SOFT	GRADONE A COSTA RETTA 30x34 cm Rect - 12"x13 ^{3/8} " ± 9,5 mm SOFT	BATTISCOPA SCALA DX (kit 2 pezzi) 10x45 cm Rect - 4"x18" ± 10 mm SOFT	BATTISCOPA SCALA SX (kit 2 pezzi) 10x45 cm Rect - 4"x18" ± 10 mm SOFT	ELEMENTO "L" 15x30x4 cm - 6"x12"x1 ^{9/16} " ± 9 mm STRUTTURATO*
WHITE PRIME	PGRPM00	PGRPML0	PGEPM01	PGEPM00	PGZPM0D	PGZPM0S	-
SILVER PRIME	PGRPM20	PGRPML2	PGEPM21	PGEPM20	PGZPM2D	PGZPM2S	PGZPMA2
SAND PRIME	PGRPM40	PGRPML4	PGEPM41	PGEPM40	PGZPM4D	PGZPM4S	PGZPMA4
GREIGE PRIME	PGRPM30	PGRPML3	PGEPM31	PGEPM30	PGZPM3D	PGZPM3S	-
BLACK PRIME	PGRPM10	PGRPML1	PGEPM11	PGEPM10	PGZPM1D	PGZPM1S	-

GRES A MASSA COLORATA_COLOURED-BODY STONEWARE 20 mm

	COSTA TORO ANGOLARE DX 30x90 cm Rect - 12"x36" STRUTTURATO*	COSTA TORO ANGOLARE SX 30x90 cm Rect - 12"x36" STRUTTURATO*	COSTA TORO 30x90 cm Rect - 12"x36" STRUTTURATO*	COSTA TORO GRIP 30x90 cm Rect - 12"x36" STRUTTURATO*	COSTA RETTA ANGOLARE DX 30x90 cm Rect - 12"x36" STRUTTURATO*	COSTA RETTA ANGOLARE SX 30x90 cm Rect - 12"x36" STRUTTURATO*
SILVER PRIME	PGDPMC2	PGDPMC7	PGFPMF2	PGFPMJ2	PGDPM22	PGDPM25
SAND PRIME	PGDPMC4	PGDPMC9	PGFPMF4	PGFPMJ4	PGDPM44	PGDPM49
GREIGE PRIME	PGDPMC3	PGDPMC6	PGFPMF3	PGFPMJ3	PGDPM33	PGDPM36
BLACK PRIME	PGDPMC1	PGDPMC5	PGFPMF1	PGFPMJ1	PGDPM11	PGDPM15

	COSTA RETTA 30x90 cm Rect - 12"x36" STRUTTURATO*	COSTA RETTA GRIP 30x90 cm Rect - 12"x36" STRUTTURATO*	GRIGLIA ANGOLARE DX 15x45 cm Rect - 6"x18" STRUTTURATO*	GRIGLIA ANGOLARE SX 15x45 cm Rect - 6"x18" STRUTTURATO*	GRIGLIA 15x45 cm Rect - 6"x18" STRUTTURATO*
SILVER PRIME	PGFPMC2	PGFPMG2	PGDPA2	PGDPA7	PGDPMZ2
SAND PRIME	PGFPMC4	PGFPMG4	PGDPA4	PGDPA9	PGDPMZ4
GREIGE PRIME	PGFPMC3	PGFPMG3	PGDPA3	PGDPA6	PGDPMZ3
BLACK PRIME	PGFPMC1	PGFPMG1	PGDPA1	PGDPA5	PGDPMZ1

PEZZI SPECIALI 20 mm: venduti solo a scatole complete, lavorati solo su richiesta, consegna 30 gg. TRIM PIECES 20 mm: only full boxes sold, manufactured only upon special request, 30 days delivery. SPEZIALTEILE 20 mm: nur als komplette Kartons verkauft, nur auf Anfrage verarbeitet, Lieferzeit 30 Tage. PIECES SPECIALES 20 mm vendus uniquement par boîte complète, produits uniquement à la demande, livraison 30 jours

* Protezione antibatterica non presente_No antimicrobial protectio_Der Antibakterielle Schutz nicht vorhanden_Protection antibactérienne pas présente

IMBALLAGGI E PESI_PACKINGS AND WEIGHTS

DESCRIZIONE Description	± mm	FORMATI Sizes	SCATOLA_Box				PALLET			
			Box	KG	M ²	ML	Box	KG	M ²	
FONDO SOFT	5,5	100x300 RECT	1	34,5	3	-	13	448,5	39	
FONDO SOFT	5,5	100x250 RECT	1	28,75	2,5	-	13	373,75	32,50	
FONDO SOFT	5,5	100x100 RECT	2	23	2	-	25	575	50	
FONDO SOFT	5,5	50x100 RECT	3	17,25	1,50	-	32	552	48	
FONDO SOFT / LUX	9,5	90x90 RECT	2	34,6	1,62	-	25	865	40,5	
FONDO SOFT / LUX	9,5	45x90 RECT	3	25,9	1,215	-	30	777	36,5	
FONDO SOFT / LUX	9,5	60x60 RECT	4	31,8	1,44	-	32	1018	46,1	
FONDO SOFT	9,5	30x60 RECT	8	31,8	1,44	-	32	1018	46,1	
FONDO STRUTTURATO	9,5	60,3x60,3	4	31,8	1,454	-	32	1018	46,5	
FONDO STRUTTURATO	9,5	30x60 RECT	8	31,8	1,44	-	32	1018	46,1	
FONDO STRUTTURATO	9,5	20x60 RECT	13	31,9	1,56	-	30	957	46,8	
FONDO STRUTTURATO	9,5	15x60 RECT	16	29,5	1,44	-	32	942	46,1	
MOSAICO 16 PZ.	9,5	30x30 RECT	4	7,2	0,36	-	78	562	28,1	
MURETTO	9,5	30x60 RECT	4	15,7	0,72	-	30	471	21,6	
BATTISCOPA SOFT / LUX	10	10x60 RECT	12	18	0,72	7,20	60	1080	43,2	
BATTISCOPA SCALA KIT (2 PZ.) SOFT	10	10x45	5	8,5	0,425	-	-	-	-	
GRADONE A COSTA RETTA SOFT	9,5	30x34	6	17,1	0,612	-	30	513	18,4	
ANGOLO GRADONE A COSTA RETTA SOFT	9,5	34x34	2	6,3	0,231	-	48	301	11,1	
ELEMENTO "L" STRUTTURATO	9	15x30xh4	8	9,6	0,36	2,40	48	460,80	17,28	
FONDO	9	20x60 RECT	14	24,30	1,68	-	40	972	67,20	
PREINCISO	9	20x60 RECT	14	24,30	1,68	-	40	972	67,20	
STREAM	9	20x60 RECT	14	24,30	1,68	-	40	972	67,20	
SQUARE	9	20x60 RECT	14	24,30	1,68	-	40	972	67,20	
LISTELLO	9	6,5x60 RECT	6	2,34	0,234	-	-	-	-	
FONDO STRUTTURATO	20	45x90 RECT	2	36,23	0,81	-	24	869,52	19,44	
COSTA TORO STRUTTURATO	20	30x90 RECT	1	12,20	0,27	-	32	390,4	8,64	
ANGOLO COSTA TORO STRUTTURATO	20	30x90 RECT	1	10,20	0,225	-	32	326,4	7,2	
COSTA TORO GRIP STRUTTURATO	20	30x90 RECT	1	12,20	0,27	-	32	390,4	8,64	
COSTA RETTA STRUTTURATO	20	30x90 RECT	1	12,20	0,27	-	32	390,4	8,64	
ANGOLO COSTA RETTA STRUTTURATO	20	30x90 RECT	1	10,20	0,225	-	32	326,4	7,2	
COSTA RETTA GRIP STRUTTURATO	20	30x90 RECT	1	12,20	0,27	-	32	390,4	8,64	
GRIGLIA STRUTTURATO	20	15x45 RECT	4	1,6	0,27	-	48	76,8	12,96	
ANGOLO GRIGLIA STRUTTURATO	20	15x45 RECT	4	1,6	0,225	-	48	76,8	10,8	



Rock Style

Fiordo



R-GOLD



R-SILVER



R-ROYAL

GRES SMALTATO_GLAZED PORCELAIN STONEWARE



± 10 mm



30x56,5 cm
12"x22^{1/4}"

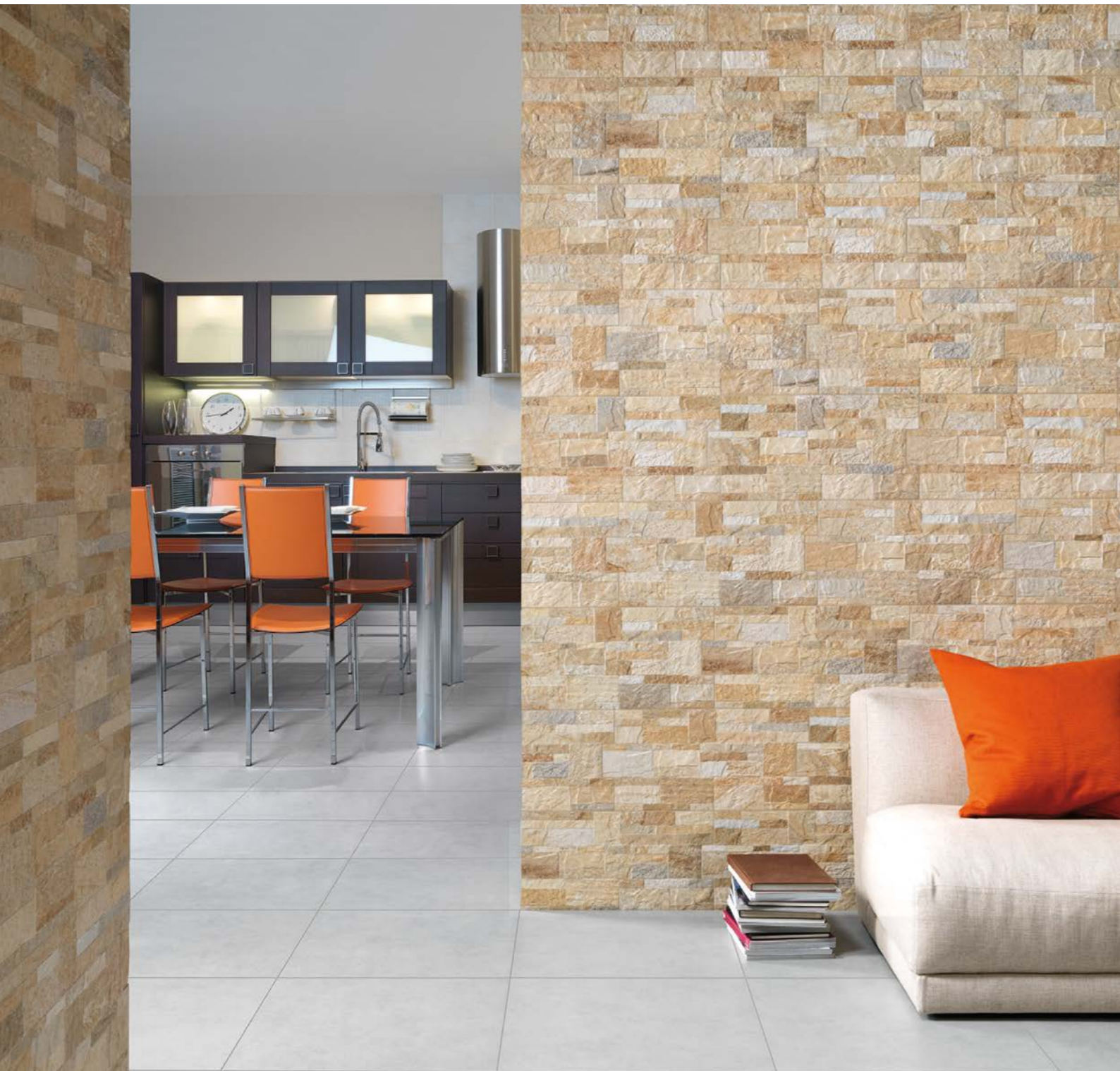

RIVESTIMENTO / WALL R-Royal 30x56,5 cm - 12"x24 1/4"



RIVESTIMENTO / WALL R-Gold 30x56,5 cm - 12"x24 1/4"



RIVESTIMENTO / WALL R-Royal 30x56,5 cm - 12"x24 1/4" R-Silver 30x56,5 cm - 12"x24 1/4"

Rock Style

GRES SMALTATO_GLAZED PORCELAIN STONEWARE

R-GOLD



30x56,5 cm - 12"x22^{1/4}"
± 10 mm
FG-RS10

R-SILVER



30x56,5 cm - 12"x22^{1/4}"
± 10 mm
FG-RS00

R-ROYAL



30x56,5 cm - 12"x22^{1/4}"
± 10 mm
FG-RS20

DATI TECNICI_TECHNICAL DATA:

GRES SMALTATO GLAZED PORCELAIN STONEWARE	
±	10 mm
	ANSI A137.1: V3

PEZZI SPECIALI_TRIM PIECES

GRES SMALTATO_GLAZED PORCELAIN STONEWARE

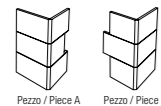

ROUND CORNER
16x12x30 cm Rect - 6^{1/4}"x4^{3/4}"x12"
± 10 mm
NATURALE

R-GOLD	FGZRS50
R-SILVER	FGZRS70
R-ROYAL	FGZRS60

IMBALLAGGI E PESI_PACKINGS AND WEIGHTS

DESCRIZIONE Description	± mm	FORMATI Sizes	SCATOLA_Box				PALLET			
FONDO NATURALE	10	30x56,5	7	25,80	1,186	-	32	825,6	37,968	
ROUND CORNER NATURALE	10	16x12x30	4	6,80	0,192	1,2	28	190,4	5,376	

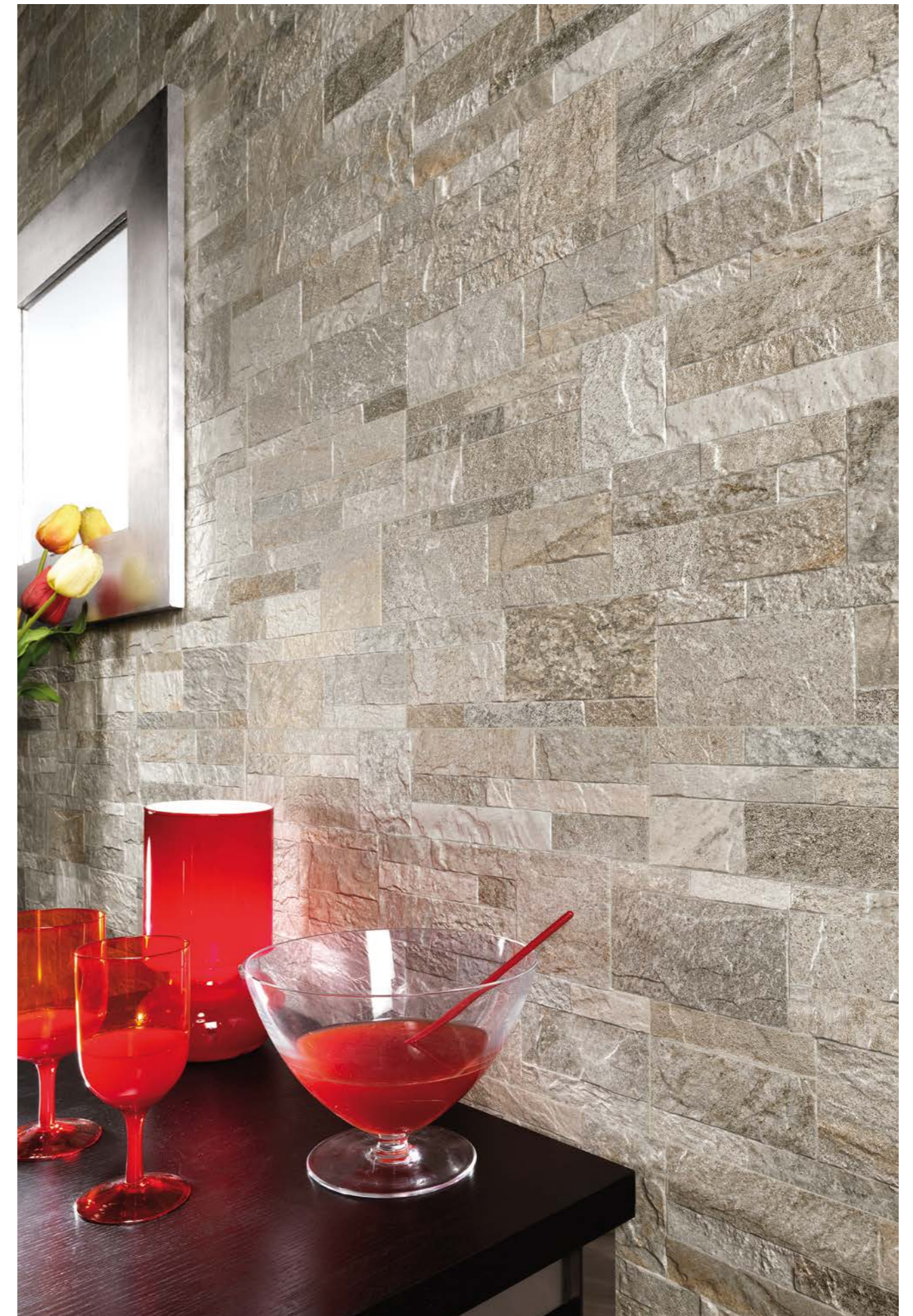

RIVESTIMENTO / WALL R-Silver 30x56,5 cm - 12"x22^{1/4}"



Tracks

Fiordo



PALE



SOIL



ASH



MUD

GRES A MASSA COLORATA_COLOURED-BODY STONEWARE



± 8 mm
± 9,5 mm



60x60 cm Rect
24"x24"
60,3x60,3 cm
24"x24"



30x60 cm Rect
12"x24"
30x60,3 cm
12"x24"

GRES A MASSA COLORATA_COLOURED-BODY STONEWARE **20 mm**



± 20 mm



60x60 cm Rect
24"x24"
60,3x60,3 cm
24"x24"



RIVESTIMENTO / WALL Pale Blend 30x60 cm Rect - 12"x24"
PAVIMENTO / FLOOR Pale 60x60 cm Rect - 24"x24"



PAVIMENTO / FLOOR Ash 60x60 cm Rect - 24"x24"



RIVESTIMENTO / WALL Soil Blend 30x60 cm Rect - 12"x24"
PAVIMENTO / FLOOR Soil Strutturato 30x60,3 cm - 12"x24"



RIVESTIMENTO / WALL Dark Blend 30x60 cm Rect - 12"x24"
 PAVIMENTO / FLOOR Mud 60x60 cm Rect - 24"x24"

Tracks

PALE



SOIL



ASH



MUD



DESTINAZIONI D'USO_INTENDED USE: NATURALE STRUTTURATO

DATI TECNICI_TECHNICAL DATA:

GRES A MASSA COLORATA COLOURED-BODY STONEWARE		GRES A MASSA COLORATA COLOURED-BODY STONEWARE	
±	8 / 9,5 mm		20 mm
DIN 51130:	R10 Naturale R11 Strutturato	DIN 51130:	R11
DIN 51097:	A Naturale (Pale) B (A+B) Naturale (Soil, Ash, Mud) C (A+B+C) Strutturato	DIN 51097:	C (A+B+C)
BCR TORTUS:	μ > 0,40	BCR TORTUS:	μ > 0,40
ANSI A326.3:	DCOF ≥ 0.42	ANSI A326.3:	DCOF ≥ 0.42
	ANSI A137.1: V2		ANSI A137.1: V2

Tracks

GRES A MASSA COLORATA_COLOURED-BODY STONEWARE

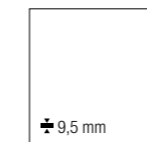

60x60 cm Rect - 24"x24"

PALE NATURALE FGWTKR2
SOIL NATURALE FGWTKR3
ASH NATURALE FGWTKR0
MUD NATURALE FGWTKR1

60,3x60,3 cm - 24"x24"

PALE NATURALE FGWTK20
SOIL NATURALE FGWTK30
ASH NATURALE FGWTK00
MUD NATURALE FGWTK10



30x60 cm Rect - 12"x24"

PALE NATURALE FG-TKR2
SOIL NATURALE FG-TKR3
ASH NATURALE FG-TKR0
MUD NATURALE FG-TKR1



30x60,3 cm - 12"x24"

SOIL STRUTTURATO FG-TKS3
ASH STRUTTURATO FG-TKS0
MUD STRUTTURATO FG-TKS1

GRES A MASSA COLORATA_COLOURED-BODY STONEWARE 20 mm



60x60 cm Rect - 24"x24"

SOIL STRUTTURATO FGWTK63
ASH STRUTTURATO FGWTK60
MUD STRUTTURATO FGWTK61

60,3x60,3 cm - 24"x24"

SOIL STRUTTURATO FGWTK53
ASH STRUTTURATO FGWTK50
MUD STRUTTURATO FGWTK51

DECORI_DECORS

GRES A MASSA COLORATA_COLOURED-BODY STONEWARE

PALE



BLEND*
30x60 cm - 12"x24"

FG-TK20

SOIL



BLEND*
30x60 cm - 12"x24"

FG-TK30

DARK

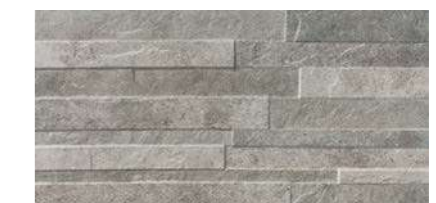

BLEND*
30x60 cm - 12"x24"

FG-TK00

Abbinabile ai colori Ash e Mud
Suitable for Ash and Mud colors
Mit den Farben Ash und Mud kombinierbar
À combiner avec les couleurs Ash et Mud

* Muretto 3D con variazione di spessore all'interno del singolo pezzo (max 12,5 mm)_3D brick-tile with thickness variability inside every single piece (max 12,5 mm)_3D Verblände ist in dem Stück- Stärke variabel (max. Stärke 12,5 mm)_"Muretto 3D" avec variation d'épaisseur à l'intérieur du carreau (max 12,5 mm)

PEZZI SPECIALI_TRIM PIECES

GRES A MASSA COLORATA_COLOURED-BODY STONEWARE

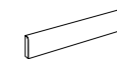

BATTISCOPA
10x60 cm Rect - 4"x24"

± 10 mm

NATURALE

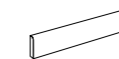

BATTISCOPA
10x60,3 cm - 4"x24"

± 10 mm

NATURALE

PALE	FGRTKR2	FGRTK20
SOIL	FGRTKR3	FGRTK30
ASH	FGRTKR0	FGRTK00
MUD	FGRTKR1	FGRTK10

IMBALLAGGI E PESI_PACKINGS AND WEIGHTS

DESCRIZIONE Description	± mm	FORMATI Sizes	SCATOLA_Box				PALLET			
FONDO NATURALE	9,5	60x60 RECT	4	31,8	1,44	-	32	1018	46,1	
FONDO NATURALE	9,5	60,3x60,3	4	31,8	1,454	-	32	1018	46,5	
FONDO NATURALE	9,5	30x60 RECT	8	31,8	1,44	-	32	1018	46,1	
FONDO STRUTTURATO	8	30x60,3	10	30,1	1,809	-	32	963	57,9	
BLEND	-	30x60 RECT	6	24	1,08	-	32	768	34,56	
BATTISCOPA NATURALE	10	10x60 RECT	12	15,48	0,7200	7,20	60	928,80	43,20	
BATTISCOPA NATURALE	10	10x60,3	16	20	0,964	9,648	48	960	46,31	
FONDO STRUTTURATO	20	60x60 RECT	2	32	0,720	-	32	1024	23,04	
FONDO STRUTTURATO	20	60,3x60,3	2	33,50	0,727	-	32	1072	23,27	



Effetto cemento

Concrete look



RIVESTIMENTO / WALL Square 120x260 cm Rect - 48"x102"
 PAVIMENTO / FLOOR Square 60x60 cm Rect - 24"x24"

Context

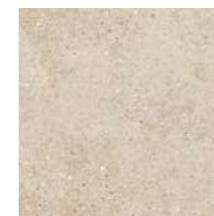

SQUARE

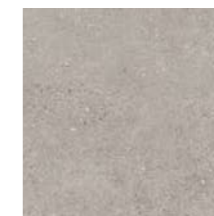

LOFT



STORE



HANGAR



MANSION

GRES PORCELLANATO LAMINATO_LAMINATED PORCELAIN STONEWARE **Zero.3**



± 6 mm

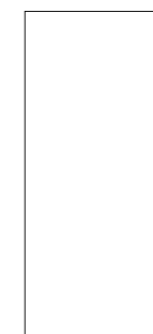

120x260 cm Rect
48"x102"

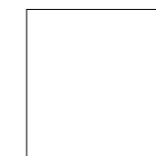

120x120 cm Rect
48"x48"

GRES A MASSA COLORATA_COLOURED-BODY STONEWARE



± 9,5 mm



90x90 cm Rect
36"x36"



60x120 cm Rect
24"x48"



60x60 cm Rect
24"x24"
60,3x60,3 cm
24"x24"



30x60 cm Rect
12"x24"

GRES A MASSA COLORATA_COLOURED-BODY STONEWARE **20 mm**



± 20 mm



60x120 cm Rect
24"x48"



RIVESTIMENTO / WALL Mansion 120x260 cm Rect - 48"x102" _Mansion Muretto 3D 30x60 cm - 12"x24"
PAVIMENTO / FLOOR Mansion 90x90 cm Rect - 36"x36"



RIVESTIMENTO / WALL Square Naturale 120x260 cm Rect - 48"x102"
PAVIMENTO / FLOOR Square Strutturato 60x60 cm Rect - 24"x24" _Square Strutturato 60x120 cm Rect - 24"x48"



RIVESTIMENTO / WALL Hangar Naturale 120x260 cm Rect - 48"x102"
PAVIMENTO / FLOOR Hangar Naturale 60x60 cm Rect - 24"x24"



RIVESTIMENTO / WALL Loft 120x260 cm Rect - 48"x102"
PAVIMENTO / FLOOR Loft Venice 60x60 cm Rect - 24"x24"



RIVESTIMENTO / WALL Loft 120x260 cm Rect - 48"x102"
PAVIMENTO / FLOOR Loft 120x120 cm Rect - 48"x48"



RIVESTIMENTO / WALL Store 120x260 cm Rect - 48"x102"
PAVIMENTO / FLOOR Store 120x120 cm Rect - 48"x48"

Context

PROTECT
ANTIBATTERICO - ANTIMICROBIAL

SQUARE



LOFT



STORE



HANGAR



MANSION



DESTINAZIONI D'USO_INTENDED USE: NATURALE / SOFT STRUTTURATO / EXT

DATI TECNICI_TECHNICAL DATA:

GRES PORCELLANATO LAMINATO LAMINATED PORCELAIN STONEWARE	GRES A MASSA COLORATA COLOURED-BODY STONEWARE	GRES A MASSA COLORATA COLOURED-BODY STONEWARE
6 mm	9,5 mm	20 mm
DIN 51130: R10 BCR TORTUS: $\mu > 0,40$ ANSI A326.3: DCOF $\geq 0,42$	DIN 51130: R10 Naturale / Soft R11 Strutturato / Ext DIN 51097: B (A+B) Naturale / Soft C (A+B+C) Strutturato / Ext BCR TORTUS: $\mu > 0,40$ ANSI A326.3: DCOF $\geq 0,42$ AS/NZS 4586: P3 Naturale / Soft P4 Strutturato / Ext BS 7976-2: PTV 36+WET (SI.96) Naturale / Soft PTV 36+WET (SI.96 - SI.55) Strutturato / Ext	DIN 51130: R11 DIN 51097: C (A+B+C) BCR TORTUS: $\mu > 0,40$ ANSI A326.3: DCOF $\geq 0,42$ AS/NZS 4586: P4 BS 7976-2: PTV 36+WET (SI.96 - SI.55)
ANSI A137.3: V2	ANSI A137.1: V2	ANSI A137.1: V2
PROTECT ANTIBATTERICO - ANTIMICROBIAL	PROTECT ANTIBATTERICO - ANTIMICROBIAL	

Context

GRES PORCELLANATO LAMINATO_LAMINATED PORCELAIN STONEWARE **Zero.3**

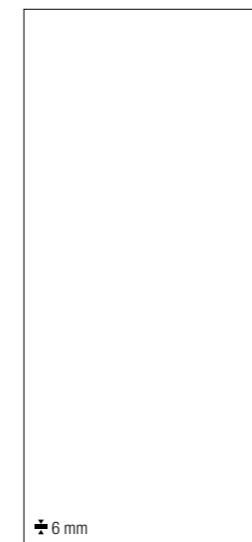

120x260 cm Rect - 48"x102"

Square NATURALE PZ6XT301
Loft NATURALE PZ6XT101
Store NATURALE PZ6XT401
Hangar NATURALE PZ6XT001
Mansion NATURALE PZ6XT201

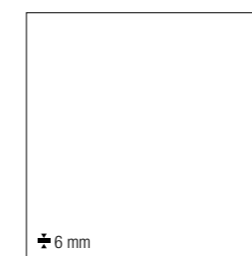

120x120 cm Rect - 48"x48"

Square NATURALE PZ8XT30
Loft NATURALE PZ8XT10
Store NATURALE PZ8XT40
Hangar NATURALE PZ8XT00
Mansion NATURALE PZ8XT20

GRES A MASSA COLORATA_COLOURED-BODY STONEWARE



90x90 cm Rect - 36"x36"

Square NATURALE PGGXT30
Loft NATURALE PGGXT10
Store NATURALE PGGXT40
Hangar NATURALE PGGXT00
Mansion NATURALE PGGXT20
Square SOFT PGGXT31
Loft SOFT PGGXT11
Store SOFT PGGXT41
Hangar SOFT PGGXT01
Mansion SOFT PGGXT21
Square EXT* PGGXT35
Loft EXT* PGGXT15
Mansion EXT* PGGXT25



60x120 cm Rect - 24"x48"

Square NATURALE PGXXT30
Loft NATURALE PGXXT10
Store NATURALE PGXXT40
Hangar NATURALE PGXXT00
Mansion NATURALE PGXXT20
Square SOFT PGXXT31
Loft SOFT PGXXT11
Store SOFT PGXXT41
Hangar SOFT PGXXT01
Mansion SOFT PGXXT21

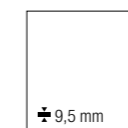

60x60 cm Rect - 24"x24"

Square NATURALE PGWXT30
Loft NATURALE PGWXT10
Store NATURALE PGWXT40
Hangar NATURALE PGWXT00
Mansion NATURALE PGWXT20
Square SOFT PGWXT31
Loft SOFT PGWXT11
Store SOFT PGWXT41
Hangar SOFT PGWXT01
Mansion SOFT PGWXT21
Square STRUTTURATO* PGWXT35
Loft STRUTTURATO* PGWXT15
Store STRUTTURATO* PGWXT45
Hangar STRUTTURATO* PGWXT05
Mansion STRUTTURATO* PGWXT25

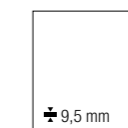

60,3x60,3 cm - 24"x24"

Square NATURALE PGWXTB3
Loft NATURALE PGWXTB1
Store NATURALE PGWXTB4
Hangar NATURALE PGWXTB0
Mansion NATURALE PGWXTB2



30x60 cm Rect - 12"x24"

Square NATURALE PG-XT30
Loft NATURALE PG-XT10
Store NATURALE PG-XT40
Hangar NATURALE PG-XT00
Mansion NATURALE PG-XT20
Square SOFT PG-XT31
Loft SOFT PG-XT11
Store SOFT PG-XT41
Hangar SOFT PG-XT01
Mansion SOFT PG-XT21
Square STRUTTURATO* PG-XT35
Loft STRUTTURATO* PG-XT15
Store STRUTTURATO* PG-XT45
Hangar STRUTTURATO* PG-XT05
Mansion STRUTTURATO* PG-XT25

GRES A MASSA COLORATA_COLOURED-BODY STONEWARE **20 mm**

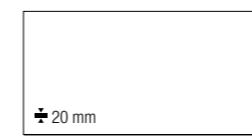

60x120 cm Rect - 24"x48"

Square STRUTTURATO* PGXXT63
Loft STRUTTURATO* PGXXT61
Store STRUTTURATO* PGXXT64
Hangar STRUTTURATO* PGXXT60
Mansion STRUTTURATO* PGXXT62

* Protezione antibatterica non presente_No antimicrobial protectio_Der Antibakterielle Schutz nicht vorhanden_Protection antibactérienne pas présente

Context

DECORI_DECORS

GRES A MASSA COLORATA_COLOURED-BODY STONEWARE

SQUARE

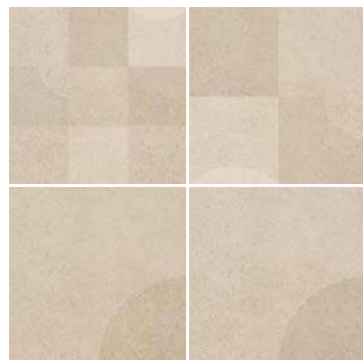

QUARTER
60x60 cm Rect - 24"x24"
± 9,5 mm
PGWXTQ3

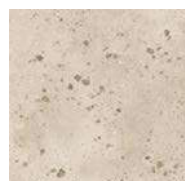

VENICE
60x60 cm Rect - 24"x24"
± 9,5 mm
PGWXT53



MURETTO 3D
30x60 cm Rect - 12"x24"
± 9,5 mm
PG-XTM3



MOSAICO 36 PEZZI
30x30 cm Rect - 12"x12"
± 9,5 mm
PGZXTM3

LOFT

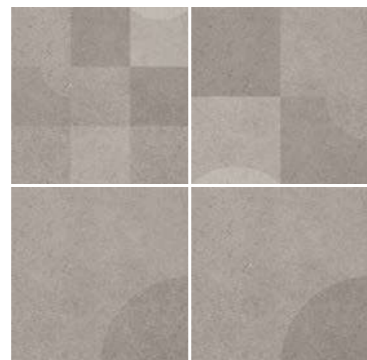

QUARTER
60x60 cm Rect - 24"x24"
± 9,5 mm
PGWXTQ1



VENICE
60x60 cm Rect - 24"x24"
± 9,5 mm
PGWXT51



MURETTO 3D
30x60 cm Rect - 12"x24"
± 9,5 mm
PG-XTM1



MOSAICO 36 PEZZI
30x30 cm Rect - 12"x12"
± 9,5 mm
PGZXTM1

STORE

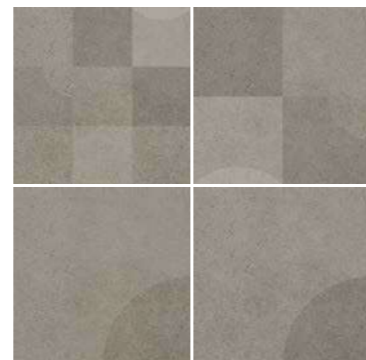

QUARTER
60x60 cm Rect - 24"x24"
± 9,5 mm
PGWXTQ4



VENICE
60x60 cm Rect - 24"x24"
± 9,5 mm
PGWXT54



MURETTO 3D
30x60 cm Rect - 12"x24"
± 9,5 mm
PG-XTM4



MOSAICO 36 PEZZI
30x30 cm Rect - 12"x12"
± 9,5 mm
PGZXTM4

QUARTER:
Composizione 4 pezzi_4 pieces composition
4 Stück- Komposition_Composition 4 pièces

HANGAR

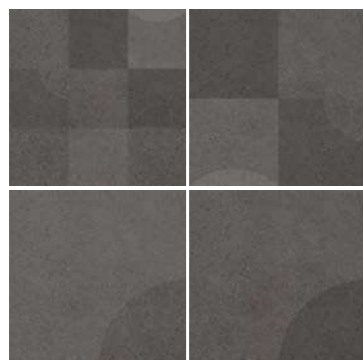

QUARTER
60x60 cm Rect - 24"x24"
± 9,5 mm
PGWXTQ0



MURETTO 3D
30x60 cm Rect - 12"x24"
± 9,5 mm
PG-XTM0



MOSAICO 36 PEZZI
30x30 cm Rect - 12"x12"
± 9,5 mm
PGZXTM0

MANSION

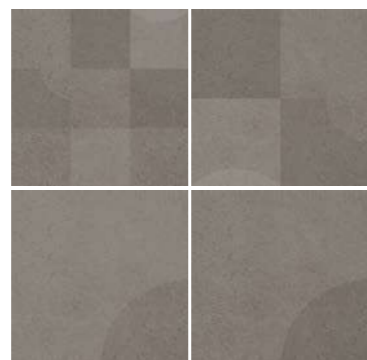

QUARTER
60x60 cm Rect - 24"x24"
± 9,5 mm
PGWXTQ2



MURETTO 3D
30x60 cm Rect - 12"x24"
± 9,5 mm
PG-XTM2



MOSAICO 36 PEZZI
30x30 cm Rect - 12"x12"
± 9,5 mm
PGZXTM2

Context

PEZZI SPECIALI_TRIM PIECES

GRES A MASSA COLORATA_COLOURED-BODY STONEWARE

BATTISCOPA 10x60 cm Rect - 4"x24" ± 10 mm NATURALE	ANGOLO GRADONE A COSTA RETTA 34x34 cm - 13 ³⁸ °x13 ³⁸ ° ± 9,5 mm NATURALE	GRADONE A COSTA RETTA 30x34 cm - 12°x13 ³⁸ ° ± 9,5 mm NATURALE	BATTISCOPA SCALA DX (kit 2 pezzi) 10x45 cm Rect - 4"x18" ± 10 mm NATURALE	BATTISCOPA SCALA SX (kit 2 pezzi) 10x45 cm Rect - 4"x18" ± 10 mm NATURALE	ELEMENTO "L" 15x30x4 cm - 6"x12"x1" ± 9 mm STRUTTURATO*
SQUARE	PGRXT30	PGEXT31	PGEXT30	PGZXT3D	PGZXT3S
LOFT	PGRXT10	PGEXT11	PGEXT10	PGZXT1D	PGZXT1S
STORE	PGRXT40	PGEXT41	PGEXT40	PGZXT4D	PGZXT4S
HANGAR	PGRXT00	PGEXT01	PGEXT00	PGZXT0D	PGZXT0S
MANSION	PGRXT20	PGEXT21	PGEXT20	PGZXT2D	PGZXT2S

GRES A MASSA COLORATA_COLOURED-BODY STONEWARE **20 mm**

COSTA TORO ANGOLARE DX 30x60 cm Rect - 12"x24" STRUTTURATO*	COSTA TORO ANGOLARE SX 30x60 cm Rect - 12"x24" STRUTTURATO*	COSTA TORO 30x60 cm Rect - 12"x24" STRUTTURATO*	COSTA TORO GRIP 30x60 cm Rect - 12"x24" STRUTTURATO*	COSTA RETTA ANGOLARE DX 30x60 cm Rect - 12"x24" STRUTTURATO*	COSTA RETTA ANGOLARE SX 30x60 cm Rect - 12"x24" STRUTTURATO*
SQUARE	PGDXTK3	PGDXTK7	PGDXTF3	PGDXTJ3	PGDXTD3
LOFT	PGDXTK1	PGDXTK9	PGDXTF1	PGDXTJ1	PGDXTD1
STORE	PGDXTK4	PGDXTK8	PGDXTF4	PGDXTJ4	PGDXTD4
HANGAR	PGDXTK0	PGDXTK5	PGDXTF0	PGDXTJ0	PGDXTD0
MANSION	PGDXTK2	PGDXTK6	PGDXTF2	PGDXTJ2	PGDXTD2
COSTA RETTA 30x60 cm Rect - 12"x24" STRUTTURATO*	COSTA RETTA GRIP 30x60 cm Rect - 12"x24" STRUTTURATO*	GRIGLIA ANGOLARE DX 15x60 cm Rect - 6"x24" STRUTTURATO*	GRIGLIA ANGOLARE SX 15x60 cm Rect - 6"x24" STRUTTURATO*	GRIGLIA 15x60 cm Rect - 6"x24" STRUTTURATO*	
SQUARE	PGDXTC3	PGDXTG3	PG1XTA3	PG1XTA7	PG1XTZ3
LOFT	PGDXTC1	PGDXTG1	PG1XTA1	PG1XTA9	PG1XTZ1
STORE	PGDXTC4	PGDXTG4	PG1XTA4	PG1XTA8	PG1XTZ4
HANGAR	PGDXTC0	PGDXTG0	PG1XTA0	PG1XTA5	PG1XTZ0
MANSION	PGDXTC2	PGDXTG2	PG1XTA2	PG1XTA6	PG1XTZ2

- Venduti solo a scatole complete_Only full boxes sold_Nur volle Karton_Vendus par boîte complete
- Lavorati solo su richiesta_Manufactured only upon special request_Nur auf Anfrage_Seulement à la demande
- Per tutti i pz speciali consegna 30 gg_For all trim pieces 30 days delivery_Formteile haben 30 Tage lieferzeit_Livraison en 30 jours pour toutes les pièces spéciales

IMBALLAGGI E PESI_PACKINGS AND WEIGHTS

DESCRIZIONE Description	± mm	FORMATI Sizes	SCATOLA_Box				PALLET			
			📦	KG	M ²	ML	📦	KG	M ²	
FONDO NATURALE	6	120x260 ^{RECT}	1	44	3,12	-	20	880	62,40	
FONDO NATURALE	6	120x120 ^{RECT}	2	40,6	2,88	-	25	1015	72	
FONDO NATURALE / SOFT	9,5	60x120 ^{RECT}	2	31,8	1,44	-	36	1145	51,8	
FONDO NATURALE / SOFT / EXT	9,5	90x90 ^{RECT}	2	34,6	1,62	-	25	865	40,5	
FONDO NATURALE / SOFT	9,5	60x60 ^{RECT}	4	31,8	1,44	-	32	1018	46,1	
FONDO NATURALE	9,5	60,3x60,3	4	31,8	1,454	-	32	1018	46,5	
FONDO NATURALE / SOFT	9,5	30x60 ^{RECT}	8	31,8	1,44	-	32	1018	46,1	
FONDO STRUTTURATO	9,5	60x60 ^{RECT}	4	31,8	1,44	-	32	1018	46,1	
FONDO STRUTTURATO	9,5	30x60 ^{RECT}	8	31,8	1,44	-	32	1018	46,1	
MOSAICO 36	9,5	30x30	4	7,3	0,36	-	78	571	28,1	
MURETTO 3D	9,5	30x60 ^{RECT}	4	15,7	0,72	-	18	283	13	
VENICE	9,5	60x60 ^{RECT}	4	31,8	1,44	-	32	1018	46,1	
QUARTER	9,5	60x60 ^{RECT}	4	31,8	1,44	-	26	827	37,4	
BATTISCOPA NATURALE	10	10x60 ^{RECT}	12	18	0,72	7,20	60	1080	43,20	
BATTISCOPA SCALA KIT (2 PZ.) NATURALE	10	10x45	5	8,5	0,425	-	-	-	-	
GRADONE A COSTA RETTA NATURALE	9,5	30x34	6	17,1	0,612	-	30	513	18,4	
ANGOLO GRADONE A COSTA RETTA NATURALE	9,5	34x34	2	6,3	0,231	-	48	301	11,1	
ELEMENTO "L" STRUTTURATO	9	15x30xh4	8	9,6	0,36	2,40	48	460,80	17,28	
FONDO STRUTTURATO	20	60x120 ^{RECT}	1	32,5	0,72	-	32	1040	23,04	
COSTA TORO STRUTTURATO	20	30x60 ^{RECT}	1	8,125	0,18	-	100	812,5	18	
ANGOLO COSTA TORO STRUTTURATO	20	30x60 ^{RECT}	1	6,1	0,135	-	100	610	13,5	
COSTA TORO GRIP STRUTTURATO	20	30x60 ^{RECT}	1	8,125	0,18	-	100	812,5	18	
COSTA RETTA STRUTTURATO	20	30x60 ^{RECT}	1	8,125	0,18	-	100	812,5	18	
ANGOLO COSTA RETTA STRUTTURATO	20	30x60 ^{RECT}	1	6,1	0,135	-	100	610	13,5	
COSTA RETTA GRIP STRUTTURATO	20	30x60 ^{RECT}	1	8,125	0,18	-	100	812,5	18	
GRIGLIA STRUTTURATO	20	15x60 ^{RECT}	2	8	0,18	-	100	800	18	
ANGOLO GRIGLIA STRUTTURATO	20	15x60 ^{RECT}	2	7	0,157	-	100	700	15,75	

* Protezione antibatterica non presente_No antimicrobial protectio_Der Antibakterielle Schutz nicht vorhanden_Protection antibactérienne pas présente



Experience



BIANCO DENSO



BEIGE TENUE



GRIGIO VIVO



NERO PURO

GRES PORCELLANATO LAMINATO_LAMINATED PORCELAIN STONEWARE **Zero.3**



± 3,5 mm



100x300 cm Rect
39"x118"



100x100 cm Rect
39"x39"



50x100 cm Rect
19^{1/2}"x39"



50x50 cm Rect
19^{1/2}"x19^{1/2}"



RIVESTIMENTO / WALL Beige Tenue 100x100 Rect - 39"x39" _ Nero Puro 100x300 Rect - 39"x118"
 PAVIMENTO / FLOOR Nero Puro 100x100 Rect - 39"x39"



RIVESTIMENTO / WALL Beige Tenue 100x300 cm Rect - 39"x118" _ Mosaico A Beige Tenue 50x50 cm Rect - 19¹/₂"x19¹/₂"
 PAVIMENTO / FLOOR Beige Tenue 100x300 cm Rect - 39"x118"

Experience

BIANCO DENSO



BEIGE TENUE



GRIGIO VIVO



NERO PURO



Experience

GRES PORCELLANATO LAMINATO_LAMINATED PORCELAIN STONEWARE **Zero.3**



100x300 cm Rect - 39"x118"

Bianco Denso NATURALE PG7EX055
 Beige Tenue NATURALE PG7EX155
 Grigio Vivo NATURALE PG7EX255
 Nero Puro NATURALE PG7EX355

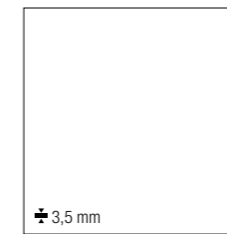

100x100 cm Rect - 39"x39"

Bianco Denso NATURALE PG8EX05
 Beige Tenue NATURALE PG8EX15
 Grigio Vivo NATURALE PG8EX25
 Nero Puro NATURALE PG8EX35

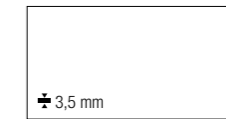

50x100 cm Rect - 19 1/2"x39"

Bianco Denso NATURALE PG9EX05
 Beige Tenue NATURALE PG9EX15
 Grigio Vivo NATURALE PG9EX25
 Nero Puro NATURALE PG9EX35

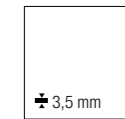

50x50 cm Rect - 19 1/2"x19 1/2"

Bianco Denso NATURALE PGVEX05
 Beige Tenue NATURALE PGVEX15
 Grigio Vivo NATURALE PGVEX25
 Nero Puro NATURALE PGVEX35

DESTINAZIONI D'USO_INTENDED USE: NATURALE

DATI TECNICI_TECHNICAL DATA:

GRES PORCELLANATO LAMINATO
 LAMINATED PORCELAIN STONEWARE

3,5 mm

DIN 51130: R9

ANSI A137.3: V2

Experience

DECORI_DECORS

GRES PORCELLANATO LAMINATO_LAMINATED PORCELAIN STONEWARE **Zero.3**

BIANCO DENSO



MOSAICO A
50x50 cm Rect - 19¹/₂"x19¹/₂"
± 3 mm
PGZEX00

BEIGE TENUE



MOSAICO A
50x50 cm Rect - 19¹/₂"x19¹/₂"
± 3 mm
PGZEX01

GRIGIO VIVO



MOSAICO A
50x50 cm Rect - 19¹/₂"x19¹/₂"
± 3 mm
PGZEX02

NERO PURO



MOSAICO A
50x50 cm Rect - 19¹/₂"x19¹/₂"
± 3 mm
PGZEX03



MOSAICO B
25x25 cm Rect - 10"x10"
± 3 mm
PGZEX10



MOSAICO B
25x25 cm Rect - 10"x10"
± 3 mm
PGZEX11



MOSAICO B
25x25 cm Rect - 10"x10"
± 3 mm
PGZEX12



MOSAICO B
25x25 cm Rect - 10"x10"
± 3 mm
PGZEX13

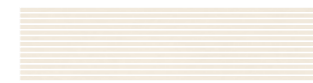

MOSAICO C
25x100 cm Rect - 10"x39"
± 3 mm
PGZEX20



MOSAICO C
25x100 cm Rect - 10"x39"
± 3 mm
PGZEX21



MOSAICO C
25x100 cm Rect - 10"x39"
± 3 mm
PGZEX22

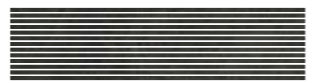

MOSAICO C
25x100 cm Rect - 10"x39"
± 3 mm
PGZEX23

Experience

FLORA



A*
100x100 cm Rect - 39"x39"
± 3,5 mm
PG8EXFA



B*
100x100 cm Rect - 39"x39"
± 3,5 mm
PG8EXFB



C*
100x100 cm Rect - 39"x39"
± 3,5 mm
PG8EXFC



E*
100x100 cm Rect - 39"x39"
± 3,5 mm
PG8EXFE



D*
100x100 cm Rect - 39"x39"
± 3,5 mm
PG8EXFD

* Posare solo a parete_Recommended only for wall applications_Nur an der Wand verlegen_Recommandé seulement pour les revêtements

Le dimensioni dei decori sono personalizzabili_Decors dimensions can be customized_Das Format der Dekoren ist auf Wunsch realisierbar_La dimension des décors peut être personnalisée

Attenzione: per la pulizia dei decori attenersi scrupolosamente alle istruzioni contenute nell'imballo_Notice: to clean the decors you must follow carefully the instructions provided inside the box_Achtung: für die reinigung sich genau auf die anleitungen in der verpackung halten_Attention: pour le nettoyage des décors il faut suivre scrupuleusement les renseignements contenus dans la boîte

IMBALLAGGI E PESI_PACKINGS AND WEIGHTS

DESCRIZIONE Description	± mm	FORMATI Sizes	SCATOLA_Box				PALLET		
FONDO NATURALE	3,5	100x300 ^{RECT}	1	23,4	3	-	20	468	60
FONDO NATURALE	3,5	100x100 ^{RECT}	3	23,4	3	-	25	585	75
FONDO NATURALE	3,5	50x100 ^{RECT}	5	19,5	2,50	-	32	624	80
FONDO NATURALE	3,5	50x50 ^{RECT}	7	13,65	1,75	-	48	655,2	84
MOSAICO A	3	50x50 ^{RECT}	3	5,25	0,75	-	-	-	-
MOSAICO B	3	25x25 ^{RECT}	6	2,70	0,375	-	-	-	-
MOSAICO C	3	25x100 ^{RECT}	3	5,25	0,750	-	-	-	-
DECORI STAMPATI FLORA	3,5	100x100 ^{RECT}	1	7,8	1	-	-	-	-



Genesis

Fiordo



BIRTH



SOUL



ROOT



GLOAM

GRES A MASSA COLORATA_COLOURED-BODY STONEWARE



± 9,5 mm



60x60 cm Rect
24"x24"
60,3x60,3 cm
24"x24"



30x60 cm Rect
12"x24"



PAVIMENTO / FLOOR Soul 60x60 cm Rect - 24"x24"

Genesis

BIRTH



SOUL



ROOT



GLOAM



DESTINAZIONI D'USO_INTENDED USE: NATURALE

DATI TECNICI_TECHNICAL DATA:

GRES A MASSA COLORATA
COLOURED-BODY STONEWARE

± 9,5 mm

DIN 51130: R10 Naturale
BCR TORTUS: $\mu > 0,40$
ANSI A326.3: DCOF $\geq 0,42$

ANSI A137.1: V2

LUPEC

Genesis

GRES A MASSA COLORATA_COLOURED-BODY STONEWARE



60x60 cm Rect - 24"x24"

Birth NATURALE FGWGSR0
Soul NATURALE FGWGSR3
Root NATURALE FGWGSR2
Gloam NATURALE FGWGSR1

60,3x60,3 cm - 24"x24"

Birth NATURALE FGWGS00
Soul NATURALE FGWGS30
Root NATURALE FGWGS20
Gloam NATURALE FGWGS10



30x60 cm Rect - 12"x24"

Birth NATURALE FG-GSR0
Soul NATURALE FG-GSR3
Root NATURALE FG-GSR2
Gloam NATURALE FG-GSR1

PEZZI SPECIALI_TRIM PIECES

GRES A MASSA COLORATA_COLOURED-BODY STONEWARE



BATTISCOPIA
10x60 cm Rect - 4"x24"

± 10 mm

NATURALE

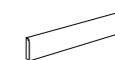

BATTISCOPIA
10x60,3 cm - 4"x24"

± 10 mm

NATURALE

	BATTISCOPIA 10x60 cm Rect - 4"x24"	BATTISCOPIA 10x60,3 cm - 4"x24"
BIRTH	FGRGSR0	FGRGS00
SOUL	FGRGSR3	FGRGS30
ROOT	FGRGSR2	FGRGS20
GLOAM	FGRGSR1	FGRGS10

IMBALLAGGI E PESI_PACKINGS AND WEIGHTS

DESCRIZIONE Description	± mm	FORMATI Sizes	SCATOLA_Box				PALLET		
FONDO NATURALE	9,5	60x60 RECT	4	31,8	1,44	-	32	1018	46,1
FONDO NATURALE	9,5	60,3x60,3	4	31,8	1,454	-	32	1018	46,5
FONDO NATURALE	9,5	30x60 RECT	8	31,8	1,44	-	32	1018	46,1
BATTISCOPIA NATURALE	10	10x60 RECT	11	15	0,66	6,60	60	900	396
BATTISCOPIA NATURALE	10	10x60,3	16	20	0,964	9,648	48	960	46,31



Glance



OFF-WHITE



PEARL



SMOKE



TAUPE



COAL

GRES A MASSA COLORATA_COLOURED-BODY STONEWARE



± 9,5 mm



90x90 cm Rect
36"x36"



45x90 cm Rect
18"x36"



60x60 cm Rect
24"x24"



30x60 cm Rect
12"x24"

RIVESTIMENTO / WALL Pearl 45x90 cm Rect - 18"x36" Light Cube 22,2x38,7 cm Rect - 8^{3/4}"x15^{1/4}"
PAVIMENTO / FLOOR Pearl 90x90 cm Rect - 36"x36"



PAVIMENTO / FLOOR Taupe 90x90 cm Rect - 36"x36"



PAVIMENTO / FLOOR Coal 60x60 cm Rect - 24"x24"

Glance

OFF-WHITE



PEARL



SMOKE



TAUPE

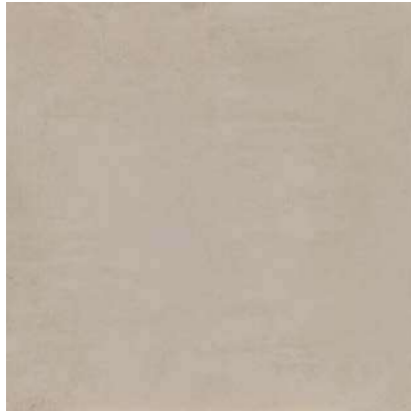

COAL

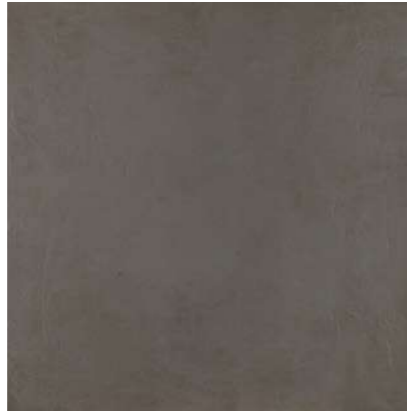

Glance

GRES A MASSA COLORATA_COLOURED-BODY STONEWARE



90x90 cm Rect - 36"x36"

Off-White NATURALE	PGGGC313
Pearl NATURALE	PGGGC013
Smoke NATURALE	PGGGC113
Taupe NATURALE	PGGGC413
Coal NATURALE	PGGGC213

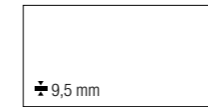

45x90 cm Rect - 18"x36"

Off-White NATURALE	PGHGC31
Pearl NATURALE	PGHGC01
Smoke NATURALE	PGHGC11
Taupe NATURALE	PGHGC41
Coal NATURALE	PGHGC21



60x60 cm Rect - 24"x24"

Off-White NATURALE	PGWGC31
Pearl NATURALE	PGWGC01
Smoke NATURALE	PGWGC11
Taupe NATURALE	PGWGC41
Coal NATURALE	PGWGC21

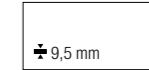

30x60 cm Rect - 12"x24"

Off-White NATURALE	PG-GC30
Pearl NATURALE	PG-GC00
Smoke NATURALE	PG-GC10
Taupe NATURALE	PG-GC40
Coal NATURALE	PG-GC20

DESTINAZIONI D'USO_INTENDED USE: NATURALE   

DATI TECNICI_TECHNICAL DATA:

GRES A MASSA COLORATA
COLOURED-BODY STONEWARE

 9,5 mm

 DIN 51130: R10 Naturale
BCR TORTUS: $\mu > 0,40$
ANSI A326.3: DCOF ≥ 0.42

 ANSI A137.1: V2

Glance

DECORI_DECORS

GRES A MASSA COLORATA_COLOURED-BODY STONEWARE

OFF-WHITE



SIGNS
45x90 cm Rect - 18"x36"
± 9,5 mm
PGHGCG3



LISTELLO SIGNS
22,5x90 cm Rect - 9"x36"
± 9,5 mm
PG2GCG3



LISTELLO RIBBON
22,5x90 cm Rect - 9"x36"
± 9,5 mm
PG2GCL3



MOSAICO 16 PEZZI
30x30 cm Rect - 12"x12"
± 9,5 mm
PGZGC30



MOSAICO ESAGONA
28,8x33,2 cm Rect - 11^{3/8}"x13^{1/8}"
± 9,5 mm
PGZGCE3



MOSAICO LIGHT CUBE
(Off-White, Pearl, Smoke)
22,2x38,7 cm Rect - 8^{3/4}"x15^{1/4}"
± 9,5 mm
PGZGCS0



LIGHT ROSES
45x90 cm Rect - 18"x36"
± 9,5 mm
PGHGCS3



LISTELLO LIGHT ROSES
22,5x90 cm Rect - 9"x36"
± 9,5 mm
PG2GCS3

PEARL



SIGNS
45x90 cm Rect - 18"x36"
± 9,5 mm
PGHGCG0



LISTELLO SIGNS
22,5x90 cm Rect - 9"x36"
± 9,5 mm
PG2GCG0



LISTELLO RIBBON
22,5x90 cm Rect - 9"x36"
± 9,5 mm
PG2GCL0



MOSAICO 16 PEZZI
30x30 cm Rect - 12"x12"
± 9,5 mm
PGZGC00



MOSAICO ESAGONA
28,8x33,2 cm Rect - 11^{3/8}"x13^{1/8}"
± 9,5 mm
PGZGCE0

SMOKE



SIGNS
45x90 cm Rect - 18"x36"
± 9,5 mm
PGHGCG1



LISTELLO SIGNS
22,5x90 cm Rect - 9"x36"
± 9,5 mm
PG2GCG1



LISTELLO RIBBON
22,5x90 cm Rect - 9"x36"
± 9,5 mm
PG2GCL1



MOSAICO 16 PEZZI
30x30 cm Rect - 12"x12"
± 9,5 mm
PGZGC10



MOSAICO ESAGONA
28,8x33,2 cm Rect - 11^{3/8}"x13^{1/8}"
± 9,5 mm
PGZGCE1

TAUPE



SIGNS
45x90 cm Rect - 18"x36"
± 9,5 mm
PGHGCG4

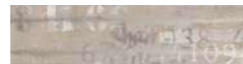

LISTELLO SIGNS
22,5x90 cm Rect - 9"x36"
± 9,5 mm
PG2GCG4



LISTELLO RIBBON
22,5x90 cm Rect - 9"x36"
± 9,5 mm
PG2GCL4



MOSAICO 16 PEZZI
30x30 cm Rect - 12"x12"
± 9,5 mm
PGZGC40



MOSAICO ESAGONA
28,8x33,2 cm Rect - 11^{3/8}"x13^{1/8}"
± 9,5 mm
PGZGCE4



MOSAICO DARK CUBE
(Off-White, Taupe, Coal)
22,2x38,7 cm Rect - 8^{3/4}"x15^{1/4}"
± 9,5 mm
PGZGCH0



DARK ROSES
45x90 cm Rect - 18"x36"
± 9,5 mm
PGHGCS2



LISTELLO DARK ROSES
22,5x90 cm Rect - 9"x36"
± 9,5 mm
PG2GCS2

COAL

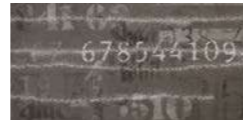

SIGNS
45x90 cm Rect - 18"x36"
± 9,5 mm
PGHGCG2



LISTELLO SIGNS
22,5x90 cm Rect - 9"x36"
± 9,5 mm
PG2GCG2



LISTELLO RIBBON
22,5x90 cm Rect - 9"x36"
± 9,5 mm
PG2GCL2



MOSAICO 16 PEZZI
30x30 cm Rect - 12"x12"
± 9,5 mm
PGZGC20



MOSAICO ESAGONA
28,8x33,2 cm Rect - 11^{3/8}"x13^{1/8}"
± 9,5 mm
PGZGCE2

Glance

PEZZI SPECIALI_TRIM PIECES

GRES A MASSA COLORATA_COLOURED-BODY STONEWARE

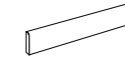

BATTISCOPIA
10x60 cm Rect - 4"x24"
± 10 mm
NATURALE

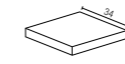

ANGOLO GRADONE A COSTA RETTA
34x34 cm - 13^{3/8}"x13^{3/8}"
± 9,5 mm
NATURALE

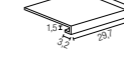

GRADONE A COSTA RETTA
30x34 cm - 12"x13^{3/8}"
± 9,5 mm
NATURALE

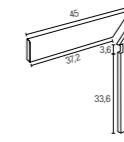

BATTISCOPIA SCALA DX (kit 2 pezzi)
10x45 cm Rect - 4"x18"
± 10 mm
NATURALE

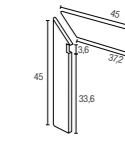

BATTISCOPIA SCALA SX (kit 2 pezzi)
10x45 cm Rect - 4"x18"
± 10 mm
NATURALE

	PGRGC31	PGEGC31	PGEGC30	PGZGC3D	PGZGC3S
OFF-WHITE	PGRGC31	PGEGC31	PGEGC30	PGZGC3D	PGZGC3S
PEARL	PGRGC01	PGEGC01	PGEGC00	PGZGC0D	PGZGC0S
SMOKE	PGRGC11	PGEGC11	PGEGC10	PGZGC1D	PGZGC1S
TAUPE	PGRGC41	PGEGC41	PGEGC40	PGZGC4D	PGZGC4S
COAL	PGRGC21	PGEGC21	PGEGC20	PGZGC2D	PGZGC2S

IMBALLAGGI E PESI_PACKINGS AND WEIGHTS

DESCRIZIONE Description	± mm	FORMATI Sizes	SCATOLA_Box				PALLET		
FONDO NATURALE	9,5	90x90 ^{RECT}	2	34,6	1,62	-	25	865	40,5
FONDO NATURALE	9,5	45x90 ^{RECT}	3	25,9	1,215	-	30	777	36,5
FONDO NATURALE	9,5	60x60 ^{RECT}	4	31,8	1,44	-	32	1018	46,1
FONDO NATURALE	9,5	30x60 ^{RECT}	8	31,8	1,44	-	32	1018	46,1
MOSAICO 16 PZ.	9,5	30x30 ^{RECT}	4	7,2	0,36	-	78	562	28,1
MOSAICO ESAGONA	9,5	28,8x33,2 ^{RECT}	4	8,4	0,382	-	60	502	22,9
MOSAICO CUBE	9,5	22,2x38,7 ^{RECT}	4	7,1	0,343	-	72	513	24,7
ROSES	9,5	45x90 ^{RECT}	2	17,3	0,81	-	15	259	12,2
LISTELLO ROSES / RIBBON	9,5	22,5x90 ^{RECT}	2	8,6	0,405	-	45	389	18,2
SIGNS	9,5	45x90 ^{RECT}	3	25,9	1,215	-	7	181	8,5
LISTELLO SIGNS	9,5	22,5x90 ^{RECT}	3	13	0,607	-	45	583	27,3
BATTISCOPIA NATURALE	10	10x60 ^{RECT}	12	15,48	0,72	7,20	60	928,8	43,2
BATTISCOPIA SCALA KIT (2 PZ.) NATURALE	10	10x45	5	8,5	0,4	-	-	-	-
GRADONE A COSTA RETTA NATURALE	9,5	30x34	6	17,5	0,612	-	30	524	18,4
ANGOLO GRADONE A COSTA RETTA NATURALE	9,5	34x34	2	6,3	0,231	-	48	301	11,1



Memory Mood



CREAMY



HAZEL



COPPER



SHEER



DIM



KEEN

GRES A MASSA COLORATA_COLOURED-BODY STONEWARE



± 8 mm
± 9,5 mm



90x90 cm Rect
36"x36"



60x60 cm Rect
24"x24"
60,3x60,3 cm
24"x24"



30x60,3 cm
12"x24"



20x20 cm
8"x8"

GRES A MASSA COLORATA_COLOURED-BODY STONEWARE **20 mm**



± 20 mm



60x60 cm Rect
24"x24"
60,3x60,3 cm
24"x24"



PAVIMENTO / FLOOR Dim 60,3x60,3 cm - 24"x24"



PAVIMENTO / FLOOR Hazel 60,3x60,3 cm - 24"x24"



PAVIMENTO / FLOOR Keen 60,3x60,3 cm - 24"x24"



RIVESTIMENTO / WALL Assi d'Alpe Stube 20x90,5 cm - 8"x36"
PAVIMENTO / FLOOR Sheer 20x20 cm - 8"x8" _Decor Mood 1 20x20 cm - 8"x8"



RIVESTIMENTO / WALL Decor Mood Mix 20x20 cm - 8"x8"



PAVIMENTO / FLOOR Hazel Strutturato 60,3x60,3 cm - 24"x24" 20 mm_Decor Mood 5 20x20 cm - 8"x8"

Memory Mood

CREAMY



HAZEL



COPPER



SHEER



DIM



KEEN



DESTINAZIONI D'USO_INTENDED USE: NATURALE STRUTTURATO

DATI TECNICI_TECHNICAL DATA:

GRES A MASSA COLORATA COLOURED-BODY STONEWARE		GRES A MASSA COLORATA COLOURED-BODY STONEWARE	
8 / 9,5 mm		20 mm	
DIN 51130: R10 Naturale DIN 51097: B (A+B) Naturale BCR TORTUS: $\mu > 0,40$ ANSI A326.3: DCOF $\geq 0,42$		DIN 51130: R11 DIN 51097: C (A+B+C) BCR TORTUS: $\mu > 0,40$ ANSI A326.3: DCOF $\geq 0,42$ AS/NZS 4586: P4 BS 7976-2: PTV 36+WET (SL96 - SL55) UNE ENV 12633: Class 3	
ANSI A137.1: V3		ANSI A137.1: V3	

Memory Mood

GRES A MASSA COLORATA_COLOURED-BODY STONEWARE



90x90 cm Rect - 36"x36"

Creamy NATURALE PGGME105
 Copper NATURALE PGGME005
 Sheer NATURALE PGGME505
 Dim NATURALE PGGME205
 Keen NATURALE PGGME405



60x60 cm Rect - 24"x24"

Creamy NATURALE PGWMER1
 Hazel NATURALE PGWMER3
 Copper NATURALE PGWMER0
 Sheer NATURALE PGWMER5
 Dim NATURALE PGWMER2
 Keen NATURALE PGWMER4

60,3x60,3 cm - 24"x24"

Creamy NATURALE PGWME10
 Hazel NATURALE PGWME30
 Copper NATURALE PGWME00
 Sheer NATURALE PGWME50
 Dim NATURALE PGWME20
 Keen NATURALE PGWME40

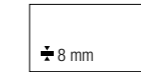

30x60,3 cm - 12"x24"

Creamy NATURALE PG-ME10
 Hazel NATURALE PG-ME30
 Copper NATURALE PG-ME00
 Sheer NATURALE PG-ME50
 Dim NATURALE PG-ME20
 Keen NATURALE PG-ME40



20x20 cm - 8"x8"

Creamy NATURALE PGEME10
 Hazel NATURALE PGEME30
 Copper NATURALE PGEME00
 Sheer NATURALE PGEME50
 Dim NATURALE PGEME20
 Keen NATURALE PGEME40

GRES A MASSA COLORATA_COLOURED-BODY STONEWARE **20 mm**



60x60 cm Rect - 24"x24"

Hazel STRUTTURATO PGWMET3
 Dim STRUTTURATO PGWMET2

60,3x60,3 cm - 24"x24"

Hazel STRUTTURATO PGWMES3
 Dim STRUTTURATO PGWMES2

Memory Mood

DECORI_DECORS

GRES A MASSA COLORATA_COLOURED-BODY STONEWARE



DECOR MOOD
20x20 cm - 8"x8"
± 8 mm

- Decor Mood 1 PGEMED1
- Decor Mood 2 PGEMED2
- Decor Mood 3 PGEMED3
- Decor Mood 4 PGEMED4
- Decor Mood 5 PGEMED5
- Decor Mood 6 PGEMED6
- Decor Mood 7 PGEMED7
- Decor Mood 8 PGEMED8
- Decor Mood 9 PGEMED9

COMPOSIZIONE DI 9 PEZZI_9 PIECES COMPOSITION







DECOR MIX
20x20 cm - 8"x8"
± 8 mm

PGEMEDM

Memory Mood



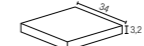

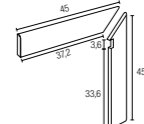
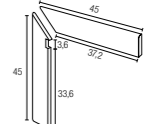

PEZZI SPECIALI_TRIM PIECES



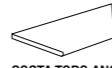

GRES A MASSA COLORATA_COLOURED-BODY STONEWARE

						
	BATTISCOPIA 10x60 cm Rect - 4"x24" ± 10 mm	BATTISCOPIA 10x60,3 cm - 4"x24" ± 10 mm	ANGOLO GRADONE A COSTA RETTA 34x34 cm - 13 ³⁸ °x13 ³⁸ ° ± 9,5 mm	GRADONE A COSTA RETTA 30x34 cm - 12"x13 ³⁸ " ± 9,5 mm	BATTISCOPIA SCALA DX (kit 2 pezzi) 10x45 cm - 4"x18" ± 10 mm	BATTISCOPIA SCALA SX (kit 2 pezzi) 10x45 cm - 4"x18" ± 10 mm
	NATURALE	NATURALE	NATURALE	NATURALE	NATURALE	NATURALE
CREAMY	PGRME11	PGRME10	PGEME11	PGEME10	PGZME1D	PGZME1S
HAZEL	PGRME31	PGRME30	PGEME31	PGEME30	PGZME3D	PGZME3S
COPPER	PGRME01	PGRME00	PGEME01	PGEME00	PGZME0D	PGZME0S
SHEER	PGRME51	PGRME50	PGEME51	PGEME50	PGZME5D	PGZME5S
DIM	PGRME21	PGRME20	PGEME21	PGEME20	PGZME2D	PGZME2S
KEEN	PGRME41	PGRME40	PGEME41	PGEME40	PGZME4D	PGZME4S

Trattandosi di pezzi artigianali possono verificarsi piccole variazioni dimensionali. Handmade pieces: light size variations may occur. Da es sich um handgemachte Teile handelt, können es kleine dimensionale Veränderungen auftreten. Étant donné qu'il s'agit de pièces faites à la main il peut y avoir des petits changements dimensionnels.

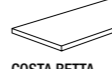





GRES A MASSA COLORATA_COLOURED-BODY STONEWARE 20 mm

						
	COSTA TORO ANGOLARE DX 30x60 cm Rect - 12"x24" STRUTTURATO	COSTA TORO ANGOLARE SX 30x60 cm Rect - 12"x24" STRUTTURATO	COSTA TORO 30x60 cm Rect - 12"x24" STRUTTURATO	COSTA TORO GRIP 30x60 cm Rect - 12"x24" STRUTTURATO	COSTA RETTA ANGOLARE DX 30x60 cm Rect - 12"x24" STRUTTURATO	COSTA RETTA ANGOLARE SX 30x60 cm Rect - 12"x24" STRUTTURATO
HAZEL	PGDMEK6	PGDMEK5	PGDMEF3	PGDMEJ3	PGDMEJ6	PGDMEJ5
DIM	PGDMEK3	PGDMEK2	PGDMEF2	PGDMEJ2	PGDMEJ3	PGDMEJ2

					
	COSTA RETTA 30x60 cm Rect - 12"x24" STRUTTURATO	COSTA RETTA GRIP 30x60 cm Rect - 12"x24" STRUTTURATO	GRIGLIA ANGOLARE DX 15x60 cm Rect - 6"x24" STRUTTURATO	GRIGLIA ANGOLARE SX 15x60 cm Rect - 6"x24" STRUTTURATO	GRIGLIA 15x60 cm Rect - 6"x24" STRUTTURATO
HAZEL	PGDMEC3	PGDMEG3	PGDMEA6	PGDMEA5	PGDMEZ3
DIM	PGDMEC2	PGDMEG2	PGDMEA3	PGDMEA2	PGDMEZ2

- Venduti solo a scatole complete. Only full boxes sold. Nur volle Karton. Vendus par boîte complete.
- Lavorati solo su richiesta. Manufactured only upon special request. Nur auf Anfrage. Seulement à la demande.
- Per tutti i pz speciali consegna 30 gg. For all trim pieces 30 days delivery. Formteile haben 30 Tage Lieferzeit. Livraison en 30 jours pour toutes les pièces spéciales.

IMBALLAGGI E PESI_PACKINGS AND WEIGHTS

DESCRIZIONE Description	± mm	FORMATI Sizes	SCATOLA_Box				PALLET		
									
FONDO NATURALE	9,5	90x90 RECT	2	34,6	1,62	-	25	865	40,5
FONDO NATURALE	9,5	60x60 RECT	4	31,8	1,44	-	32	1018	46,1
FONDO NATURALE	9,5	60,3x60,3	4	31,8	1,454	-	32	1018	46,5
FONDO NATURALE	8	30x60,3	10	-	1,809	-	32	-	57,9
FONDO NATURALE	8	20x20	34	-	1,36	-	45	-	61,2
DECOR MOOD	8	20x20	34	-	1,36	-	45	-	61,2
DECOR MIX	8	20x20	9	-	0,36	-	30	-	10,8
BATTISCOPIA NATURALE	10	10x60 RECT	12	15,48	0,72	7,20	60	928,80	43,20
BATTISCOPIA NATURALE	10	10x60,3	16	20	0,965	9,648	48	960	46,31
BATTISCOPIA SCALA KIT (2 PZ.) NATURALE	10	10x45	5	8,5	0,400	-	-	-	-
GRADONE A COSTA RETTA NATURALE	9,5	30x34	6	17,5	0,612	-	30	524	18,4
ANGOLO GRADONE A COSTA RETTA NATURALE	9,5	34x34	2	6,3	0,231	-	48	301	11,1
FONDO STRUTTURATO	20	60x60 RECT	2	33,6	0,720	-	32	1075,2	23,04
FONDO STRUTTURATO	20	60,3x60,3	2	33,5	0,727	-	32	1072	23,27
COSTA TORO STRUTTURATO	20	30x60 RECT	1	8,125	0,180	-	100	812,5	18
ANGOLO COSTA TORO STRUTTURATO	20	30x60 RECT	1	6,10	0,135	-	100	610	13,50
COSTA TORO GRIP STRUTTURATO	20	30x60 RECT	1	8,125	0,180	-	100	812,5	18
COSTA RETTA STRUTTURATO	20	30x60 RECT	1	8,125	0,180	-	100	812,5	18
ANGOLO COSTA RETTA STRUTTURATO	20	30x60 RECT	1	6,1	0,135	-	100	610	13,50
COSTA RETTA GRIP STRUTTURATO	20	30x60 RECT	1	8,125	0,180	-	100	812,5	18
GRIGLIA STRUTTURATO	20	15x60 RECT	2	8	0,180	-	100	800	18
ANGOLO GRIGLIA STRUTTURATO	20	15x60 RECT	2	7	0,157	-	100	700	15,75



Motion

Fiordo



CLEAR



LAND



MID



DUN



CARBON

GRES SMALTATO_GLAZED PORCELAIN STONEWARE



± 9,5 mm



60x60 cm Rect
24"x24"



30x60 cm Rect
12"x24"



PAVIMENTO / FLOOR Mid 60x60 cm Rect - 24"x24"



PAVIMENTO / FLOOR Clear 60x60 cm Rect - 24"x24"

Motion

CLEAR

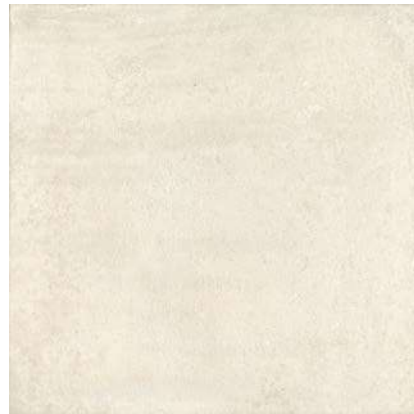

LAND



MID

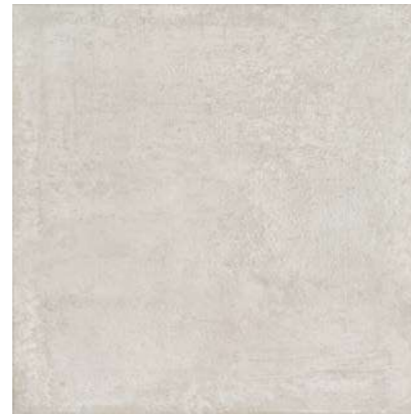



DUN





CARBON



DESTINAZIONI D'USO_INTENDED USE: NATURALE   

DATI TECNICI_TECHNICAL DATA:

GRES SMALTATO GLAZED PORCELAIN STONEWARE	
+	9,5 mm
	DIN 51130: R9 BCR TORTUS: $\mu > 0,40$ ANSI A326.3: DCOF $\geq 0,42$ ISO 10545-7: PEI 5 Clear, Mid PEI 4 Land, Dun, Carbon
	ANSI A137.1: V3

Motion

GRES SMALTATO_GLAZED PORCELAIN STONEWARE



60x60 cm Rect - 24"x24"

Clear NATURALE FGWMNR0
Land NATURALE FGWMNR2
Mid NATURALE FGWMNR3
Dun NATURALE FGWMNR1
Carbon NATURALE FGWMNR4



30x60 cm Rect - 12"x24"

Clear NATURALE FG-MNR0
Land NATURALE FG-MNR2
Mid NATURALE FG-MNR3
Dun NATURALE FG-MNR1
Carbon NATURALE FG-MNR4

PEZZI SPECIALI_TRIM PIECES







GRES SMALTATO_GLAZED PORCELAIN STONEWARE



BATTISCOPA
10x60 cm Rect - 4"x24"
+ 10 mm
NATURALE

CLEAR	FGRMNR0
LAND	FGRMNR2
MID	FGRMNR3
DUN	FGRMNR1
CARBON	FGRMNR4

IMBALLAGGI E PESI_PACKINGS AND WEIGHTS

DESCRIZIONE Description	+ mm	FORMATI Sizes	SCATOLA_Box				PALLET		
									
FONDO NATURALE	9,5	60x60 RECT	4	31,8	1,44	-	32	1018	46,1
FONDO NATURALE	9,5	30x60 RECT	8	31,8	1,44	-	32	1018	46,1
BATTISCOPA NATURALE	10	10x60 RECT	12	16,40	0,720	7,20	60	984,0	43,20



Opificio 22/a



GESO



CALCE



ARGILLA



TERRA



CENERE

GRES A MASSA COLORATA_COLOURED-BODY STONEWARE



± 9,5 mm
± 8 mm

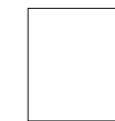

90x90 cm Rect
36"x36"



60x60 cm Rect
24"x24"



30x60 cm Rect
12"x24"



20x20 cm
8"x8"

GRES A MASSA COLORATA_COLOURED-BODY STONEWARE **20 mm**



± 20 mm



90x90 cm Rect
36"x36"

RIVESTIMENTO / WALL Trame Mix Naturale 20x20 cm - 8"x8"
PAVIMENTO / FLOOR Terra Naturale 90x90 cm Rect - 36"x36" _Trame Mix Naturale 20x20 cm - 8"x8"
Terra Ext 60x60 cm Rect - 24"x24"



RIVESTIMENTO / WALL Gesso Naturale 60x60 cm Rect - 24"x24" _Muretto Gesso Naturale 30x60 cm Rect - 12"x24"
PAVIMENTO / FLOOR Terra Naturale 60x60 cm Rect - 24"x24"



RIVESTIMENTO / WALL Cenere Naturale 20x20 cm - 8"x8" _Trame Scuro Naturale 20x20 cm - 8"x8" _Gesso Naturale 20x20 cm - 8"x8"
PAVIMENTO / FLOOR Cenere Naturale 60x60 cm Rect - 24"x24" _Trame Scuro Naturale 20x20 cm - 8"x8"



RIVESTIMENTO / WALL Argilla Naturale 20x20 cm - 8"x8" _Trame Chiaro Naturale 20x20 cm - 8"x8"
PAVIMENTO / FLOOR Argilla Naturale 60x60 cm Rect - 24"x24" _Trame Chiaro Naturale 20x20 cm - 8"x8"



RIVESTIMENTO / WALL Muretto Calce Naturale 30x60 cm Rect - 12"x24"
PAVIMENTO / FLOOR Calce Naturale 90x90 cm Rect - 36"x36"



PAVIMENTO / FLOOR Cenere Naturale 60x60 cm Rect - 24"x24" _Quadri Scuro Naturale 20x20 cm - 8"x8"



PAVIMENTO / FLOOR Calce Strutturato 90x90 cm Rect - 36"x36" 20mm

Opificio 22/a

PROTECT
ANTIBATTERICO - ANTIMICROBIAL

GESSO

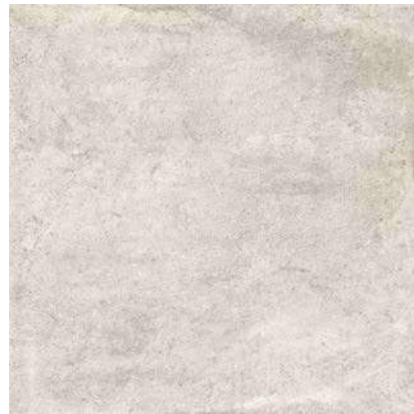

CALCE



ARGILLA



TERRA



CENERE



Opificio 22/a

GRES A MASSA COLORATA_COLOURED-BODY STONEWARE



90x90 cm Rect - 36"x36"
Gesso NATURALE PGG2A30
Calce NATURALE PGG2A10
Argilla NATURALE PGG2A00
Terra NATURALE PGG2A40
Cenere NATURALE PGG2A20



60x60 cm Rect - 24"x24"
Gesso NATURALE PGW2A80
Calce NATURALE PGW2A60
Argilla NATURALE PGW2A50
Terra NATURALE PGW2A90
Cenere NATURALE PGW2A70
Gesso EXT PGW2A30
Calce EXT PGW2A10
Argilla EXT PGW2A00
Terra EXT PGW2A40
Cenere EXT PGW2A20



30x60 cm Rect - 12"x24"
Gesso NATURALE PG-2A80
Calce NATURALE PG-2A60
Argilla NATURALE PG-2A50
Terra NATURALE PG-2A90
Cenere NATURALE PG-2A70
Gesso EXT PG-2A30
Calce EXT PG-2A10
Argilla EXT PG-2A00
Terra EXT PG-2A40
Cenere EXT PG-2A20



20x20 cm Rect - 8"x8"
Gesso NATURALE PGE2A30
Calce NATURALE PGE2A10
Argilla NATURALE PGE2A00
Terra NATURALE PGE2A40
Cenere NATURALE PGE2A20

GRES A MASSA COLORATA_COLOURED-BODY STONEWARE **20 mm**

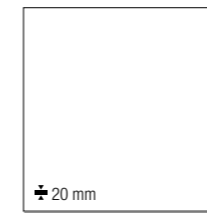

90x90 cm Rect - 36"x36"
Gesso STRUTT. PGG2A80
Calce STRUTT. PGG2A60
Argilla STRUTT. PGG2A50
Terra STRUTT. PGG2A90
Cenere STRUTT. PGG2A70

DESTINAZIONI D'USO_INTENDED USE: NATURALE STRUTTURATO / EXT

DATI TECNICI_TECHNICAL DATA:

GRES A MASSA COLORATA COLOURED-BODY STONEWARE	GRES A MASSA COLORATA COLOURED-BODY STONEWARE
+ 9,5 / 8 mm	20 mm
DIN 51130: R10 Naturale R11 Ext DIN 51097: A Naturale C (A+B+C) Ext BCR TORTUS: $\mu > 0,40$ ANSI A326.3: DCOF $\geq 0,42$ AS/NZS 4586: P4 Ext BS 7976-2: PTV 36+WET (SI.96 - SI.55) Ext	DIN 51130: R11 DIN 51097: C (A+B+C) BCR TORTUS: $\mu > 0,40$ ANSI A326.3: DCOF $\geq 0,42$ AS/NZS 4586: P4 BS 7976-2: PTV 36+WET (SI.96 - SI.55)
ANSI A137.1: V4	ANSI A137.1: V4
PROTECT ANTIBATTERICO - ANTIMICROBIAL Naturale	/

NATURALE:

Protezione antibatterica presente_Integrated antibacterial protection_Antibakterieller Schutz vorhanden_Protection antibactérienne présente

Opificio 22/a

DECORI_DECORS

GRES A MASSA COLORATA_COLOURED-BODY STONEWARE

GESSO

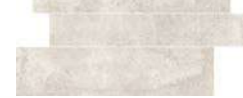

MURETTO NATURALE
30x60 cm Rect - 12"x24"
± 9,5 mm
PGZ2AM3



MOSAICO 16 PEZZI NATURALE
30x30 cm Rect - 12"x12"
± 9,5 mm
PGZ2A30

CALCE



MURETTO NATURALE
30x60 cm Rect - 12"x24"
± 9,5 mm
PGZ2AM1



MOSAICO 16 PEZZI NATURALE
30x30 cm Rect - 12"x12"
± 9,5 mm
PGZ2A10

ARGILLA



MURETTO NATURALE
30x60 cm Rect - 12"x24"
± 9,5 mm
PGZ2AM0



MOSAICO 16 PEZZI NATURALE
30x30 cm Rect - 12"x12"
± 9,5 mm
PGZ2A00

TERRA



MURETTO NATURALE
30x60 cm Rect - 12"x24"
± 9,5 mm
PGZ2AM4



MOSAICO 16 PEZZI NATURALE
30x30 cm Rect - 12"x12"
± 9,5 mm
PGZ2A40

CENERE



MURETTO NATURALE
30x60 cm Rect - 12"x24"
± 9,5 mm
PGZ2AM2

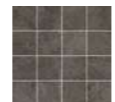

MOSAICO 16 PEZZI NATURALE
30x30 cm Rect - 12"x12"
± 9,5 mm
PGZ2A20

Abbinabile ai colori_Matches with colors_
Mit den Farben kombinierbar_À combiner avec les couleurs:
GESSO - CALCE - ARGILLA



TRAME CHIARO NATURALE
20x20 cm Rect - 8"x8"
± 8 mm
PGE2A50



QUADRI CHIARO NATURALE
20x20 cm Rect - 8"x8"
± 8 mm
PGE2A80

Abbinabile ai colori_Matches with colors_
Mit den Farben kombinierbar_À combiner avec les couleurs:
TERRA - CENERE



TRAME SCURO NATURALE
20x20 cm Rect - 8"x8"
± 8 mm
PGE2A70



QUADRI SCURO NATURALE
20x20 cm Rect - 8"x8"
± 8 mm
PGE2A90

Abbinabile a tutti i colori_Matches with all colors_
Kombinierbar mit allen Farben_Combinable à tous les coloris



TRAME MIX NATURALE
20x20 cm Rect - 8"x8"
± 8 mm
PGE2A60



GRAFFITI
30x60 cm Rect - 12"x24"
± 9,5 mm
PGZ2A50

MURETTO, MOSAICO 16 PEZZI, TRAME, QUADRI:

Possibilità di utilizzo a pavimento in interni_Suitable for interiors floor_Möglichkeit der Verwendung als Boden in Innenbereichen_Possibilité d'utilisation pour les sols à l'intérieur.

GRAFFITI:

Decoro sviluppato su 2 soggetti diversi venduti insieme_Decoration developed on 2 different patterns sold together_Dekor zu 2 verschiedenen Themen entwickelt, die zusammen verkauft werden_
Décor développé sur 2 sujets différents vendus ensemble

Protezione antibatterica non presente_No antimicrobial protectio_Der Antibakterielle Schutz nicht vorhanden_Protection antibactérienne pas présente.

Opificio 22/a

PEZZI SPECIALI_TRIM PIECES

GRES A MASSA COLORATA_COLOURED-BODY STONEWARE

BATTISCOPA 7,5x60 cm Rect - 3"x24" ± 10 mm NATURALE	GRADONE A COSTA RETTA 30x34 cm - 12"x13 3/8" ± 9,5 mm NATURALE	ANGOLO GRADONE A COSTA RETTA 34x34 cm - 13 3/8"x13 3/8" ± 9,5 mm NATURALE	BATTISCOPA SCALA DX (kit 2 pezzi) 7,5x45 cm - 4"x18" ± 10 mm NATURALE	BATTISCOPA SCALA SX (kit 2 pezzi) 7,5x45 cm - 4"x18" ± 10 mm NATURALE	ELEMENTO "L" 15x30x4 cm Rect - 6"x12"x1 9/16" ± 9,5 mm EXT
GESSO PGR2A30	PGE2A30	PGE2A31	PGZ2A3D	PGZ2A3S	PGZ2AL3
CALCE PGR2A10	PGE2A10	PGE2A11	PGZ2A1D	PGZ2A1S	PGZ2AL1
ARGILLA PGR2A00	PGE2A00	PGE2A01	PGZ2A0D	PGZ2A0S	PGZ2AL0
TERRA PGR2A40	PGE2A40	PGE2A41	PGZ2A4D	PGZ2A4S	PGZ2AL4
CENERE PGR2A20	PGE2A20	PGE2A21	PGZ2A2D	PGZ2A2S	PGZ2AL2

ELEMENTO "L":

Realizzato tramite incollaggio_Made by gluing_Hergestellt durch Kleben_Réalisé par collage

Abbinabile alla finitura Ext_To be used with Ext version_Kombinierbar mit Finish Ext_Combinable à la finition Ext

GRES A MASSA COLORATA_COLOURED-BODY STONEWARE **20 mm**

COSTA TORO ANGOLARE DX 30x90 cm Rect - 12"x36" STRUTTURATO*	COSTA TORO ANGOLARE SX 30x90 cm Rect - 12"x36" STRUTTURATO*	COSTA TORO 30x90 cm Rect - 12"x36" STRUTTURATO*	COSTA TORO GRIP 30x90 cm Rect - 12"x36" STRUTTURATO*	COSTA RETTA ANGOLARE DX 30x90 cm Rect - 12"x36" STRUTTURATO*	COSTA RETTA ANGOLARE SX 30x90 cm Rect - 12"x36" STRUTTURATO*
GESSO PGF2AK6	PGF2AK7	PGF2AF3	PGF2AJ3	PGF2AD6	PGF2AD7
CALCE PGF2AK2	PGF2AK3	PGF2AF1	PGF2AJ1	PGF2AD2	PGF2AD3
ARGILLA PGF2AK0	PGF2AK1	PGF2AF0	PGF2AJ0	PGF2AD0	PGF2AD1
TERRA PGF2AK8	PGF2AK9	PGF2AF4	PGF2AJ4	PGF2AD8	PGF2AD9
CENERE PGF2AK4	PGF2AK5	PGF2AF2	PGF2AJ2	PGF2AD4	PGF2AD5

COSTA RETTA 30x90 cm Rect - 12"x36" STRUTTURATO*	COSTA RETTA GRIP 30x90 cm Rect - 12"x36" STRUTTURATO*	GRIGLIA ANGOLARE DX 15x45 cm Rect - 6"x18" STRUTTURATO*	GRIGLIA ANGOLARE SX 15x45 cm Rect - 6"x18" STRUTTURATO*	GRIGLIA 15x45 cm Rect - 6"x18" STRUTTURATO*
GESSO PGF2AC3	PGF2AG3	PGD2AA6	PGD2AA7	PGD2AZ8
CALCE PGF2AC1	PGF2AG1	PGD2AA2	PGD2AA3	PGD2AZ6
ARGILLA PGF2AC0	PGF2AG0	PGD2AA0	PGD2AA1	PGD2AZ5
TERRA PGF2AC4	PGF2AG4	PGD2AA8	PGD2AA9	PGD2AZ9
CENERE PGF2AC2	PGF2AG2	PGD2AA4	PGD2AA5	PGD2AZ7

* Protezione antibatterica non presente_No antimicrobial protectio_Der Antibakterielle Schutz nicht vorhanden_Protection antibactérienne pas présente

Venduti solo a scatole complete_Only full boxes sold_Nur volle Karton_Vendus par boîte complete

Lavorati solo su richiesta_Manufactured only upon special request_Nur auf Anfrage_Seulement à la demande

Per tutti i pz speciali consegna 30 gg_For all trim pieces 30 days delivery_Formteile haben 30 Tage lieferzeit_Livraison en 30 jours pour toutes les pièces spéciales

IMBALLAGGI E PESI_PACKINGS AND WEIGHTS

DESCRIZIONE Description	± mm	FORMATI Sizes	SCATOLA_Box			PALLET			
FONDO NATURALE	9,5	90x90 ^{RECT}	2	34,6	1,62	-	25	865	40,5
FONDO NATURALE / EXT	9,5	60x60 ^{RECT}	4	31,8	1,44	-	32	1018	46,1
FONDO NATURALE / EXT	9,5	30x60 ^{RECT}	8	31,8	1,44	-	32	1018	46,1
FONDO NATURALE	8	20x20	34	22,6	1,36	-	45	1.017,0	61,20
FONDO STRUTTURATO	20	90x90 ^{RECT}	1	37,3	0,81	-	30	1.119,0	24,30
GRAFFITI	9,5	30x60 ^{RECT}	2	8	0,36	-	48	384	17,3
MURETTO NATURALE	9,5	30x60 ^{RECT}	4	15,7	0,72	-	30	471	21,6
MOSAICO 16 PEZZI NATURALE	9,5	30x30 ^{RECT}	4	7,2	0,36	-	78	562	28,1
TRAME CHIARO NATURALE	8	20x20	34	22,6	1,36	-	45	1.017,0	61,20
TRAME SCURO NATURALE	8	20x20	34	22,6	1,36	-	45	1.017,0	61,20
TRAME MIX NATURALE	8	20x20	34	22,6	1,36	-	45	1.017,0	61,20
QUADRI CHIARO NATURALE	8	20x20	34	22,6	1,36	-	45	1.017,0	61,20
QUADRI SCURO NATURALE	8	20x20	34	22,6	1,36	-	45	1.017,0	61,20
BATTISCOPA NATURALE	10	7,5x60 ^{RECT}	12	11,61	0,54	7,20	64	743,04	34,56
BATTISCOPA SCALA KIT (2 PZ.) NATURALE	10	7,5x45	5	7,5	0,337	-	-	-	-
GRADONE A COSTA RETTA NATURALE	9,5	30x34	6	16,6	0,612	-	30	499	18,4
ANGOLO GRADONE A COSTA RETTA NATURALE	9,5	34x34	2	6,3	0,231	-	48	301	11,1
ELEMENTO "L" EXT	9,5	15x30x4	8	8,7	0,36	2,40	48	420	17,3
COSTA TORO STRUTTURATO	20	30x90 ^{RECT}	1	12,2	0,27	-	32	390,4	8,64
ANGOLO COSTA TORO STRUTTURATO	20	30x90 ^{RECT}	1	10,2	0,225	-	32	326,4	7,20
COSTA TORO GRIP STRUTTURATO	20	30x90 ^{RECT}	1	12,2	0,27	-	32	390,4	8,64
COSTA RETTA STRUTTURATO	20	30x90 ^{RECT}	1	12,2	0,27	-	32	390,4	8,64
ANGOLO COSTA RETTA STRUTTURATO	20	30x90 ^{RECT}	1	10,2	0,225	-	32	326,4	7,20
COSTA RETTA GRIP STRUTTURATO	20	30x90 ^{RECT}	1	12,2	0,27	-	32	390,4	8,64
GRIGLIA STRUTTURATO	20	15x45 ^{RECT}	4	11,2	0,27	-	48	537,6	12,96
ANGOLO GRIGLIA STRUTTURATO	20	15x45 ^{RECT}	4	10	0,225	-	48	480,0	10,80



RIVESTIMENTO / WALL Concrete 100x300 cm Rect - 39"x118"
 PAVIMENTO / FLOOR Concrete 100x100 cm Rect - 39"x39"

Urbanature



LIME



CONCRETE



CEMENT



PORTLAND



SILICON

GRES PORCELLANATO LAMINATO_LAMINATED PORCELAIN STONEWARE **Zero.3**



± 3,5 mm



100x300 cm Rect
39"x118"



100x100 cm Rect
39"x39"



50x100 cm Rect
19^{1/2}"x39"

GRES A MASSA COLORATA_COLOURED-BODY STONEWARE



± 8 mm
± 9,5 mm



90x90 cm Rect
36"x36"



45x90 cm Rect
18"x36"

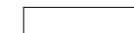

22,5x90 cm Rect
9"x36"



60x60 cm Rect
24"x24"
60,3x60,3 cm
24"x24"



30x60 cm Rect
12"x24"



45,2x45,2 cm
18"x18"

GRES A MASSA COLORATA_COLOURED-BODY STONEWARE **20 mm**



± 20 mm



60x60 cm Rect
24"x24"
60,3x60,3 cm
24"x24"



RIVESTIMENTO / WALL Lime 100x300 cm Rect - 39"x118"_Lime 100x100 cm Rect - 39"x39"_Lime 50x100 cm Rect - 19 1/2"x39"
 PAVIMENTO / FLOOR Silicon 100x100 cm Rect - 39"x39"



RIVESTIMENTO / WALL Lime 100x300 cm Rect - 39"x118"_Lime 50x100 cm Rect - 19 1/2"x39"
 PAVIMENTO / FLOOR Silicon 100x100 cm Rect - 39"x39"



RIVESTIMENTO / WALL Portland 100x300 cm Rect - 39"x118"_Portland 50x100 cm Rect - 19 1/2"x39"_Urban Stripes Portland 50x100 cm Rect - 19 1/2"x39"
PAVIMENTO / FLOOR Portland 100x100 cm Rect - 39"x39"



PAVIMENTO / FLOOR Portland 60x60 cm Rect - 24"x24" _Urban Steel Portland 60x60 cm Rect - 24"x24"



RIVESTIMENTO / WALL Portland 30x60 cm Rect - 12"x24" _Urban Texture Portland 30x60 cm Rect - 12"x24"



RIVESTIMENTO / WALL Concrete 22,5x90 cm Rect - 9"x36"
PAVIMENTO / FLOOR Concrete Strutturato 60,3x60,3 cm - 24"x24"

LIME



CONCRETE



CEMENT



PORTLAND



SILICON



DESTINAZIONI D'USO_INTENDED USE: **NATURALE** **STRUTTURATO / EXT**

DATI TECNICI_TECHNICAL DATA:

GRES PORCELLANATO LAMINATO LAMINATED PORCELAIN STONEWARE	GRES A MASSA COLORATA COLOURED-BODY STONEWARE	GRES A MASSA COLORATA COLOURED-BODY STONEWARE
± 3,5 mm	8 / 9,5 mm	20 mm
DIN 51130: R9 BCR TORTUS: $\mu > 0,40$	DIN 51130: R9 Naturale R11 Strutturato / Ext DIN 51097: C (A+B+C) Strutturato / Ext BCR TORTUS: $\mu > 0,40$ ANSI A326.3: DCOF $\geq 0,42$ AS/NZS 4586: P4 Strutturato / Ext BS 7976-2: PTV 36+WET (SL96 - SL55) Strutturato / Ext	DIN 51130: R11 DIN 51097: C (A+B+C) BCR TORTUS: $\mu > 0,40$ ANSI A326.3: DCOF $\geq 0,42$ AS/NZS 4586: P4 BS 7976-2: PTV 36+WET (SL96 - SL55)
ANSI A137.1: V2	ANSI A137.1: V2	ANSI A137.1: V2
PROTECT ANTIBATTERICO - ANTIMICROBIAL		

GRES PORCELLANATO LAMINATO_LAMINATED PORCELAIN STONEWARE **Zero.3**

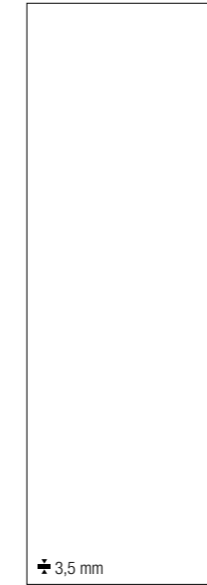

100x300 cm Rect - 39"x118"
Lime NATURALE* PZ7UN00
Concrete NATURALE* PZ7UN10
Cement NATURALE* PZ7UN20
Portland NATURALE* PZ7UN30
Silicon NATURALE* PZ7UN40



100x100 cm Rect - 39"x39"
Lime NATURALE* PZ8UN00
Concrete NATURALE* PZ8UN10
Cement NATURALE* PZ8UN20
Portland NATURALE* PZ8UN30
Silicon NATURALE* PZ8UN40

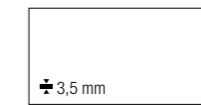

50x100 cm Rect - 19 1/2"x39"
Lime NATURALE* PZ9UN00
Concrete NATURALE* PZ9UN10
Cement NATURALE* PZ9UN20
Portland NATURALE* PZ9UN30
Silicon NATURALE* PZ9UN40

GRES A MASSA COLORATA_COLOURED-BODY STONEWARE

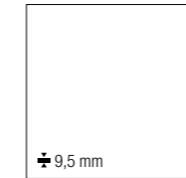

90x90 cm Rect - 36"x36"
Lime NATURALE PGGUNR05
Concrete NATURALE PGGUNR15
Cement NATURALE PGGUNR25
Portland NATURALE PGGUNR35
Silicon NATURALE PGGUNR45
Portland EXT* PGGUNG33

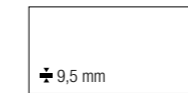

45x90 cm Rect - 18"x36"
Lime NATURALE PGHUN001
Concrete NATURALE PGHUN101
Cement NATURALE PGHUN201
Portland NATURALE PGHUN301
Silicon NATURALE PGHUN401



45,2x45,2 cm - 18"x18"
Lime NATURALE PGUUN00
Concrete NATURALE PGUUN10
Cement NATURALE PGUUN20
Portland NATURALE PGUUN30
Silicon NATURALE PGUUN40



60x60 cm Rect - 24"x24"
Lime NATURALE PGWUN01P
Concrete NATURALE PGWUN11P
Cement NATURALE PGWUN21P
Portland NATURALE PGWUN31P
Silicon NATURALE PGWUN41P



30x60 cm Rect - 12"x24"
Lime NATURALE PG-UN01
Concrete NATURALE PG-UN11
Cement NATURALE PG-UN21
Portland NATURALE PG-UN31
Silicon NATURALE PG-UN41

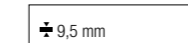

22,5x90 cm Rect - 9"x36"
Lime NATURALE PG2UN001
Concrete NATURALE PG2UN101
Cement NATURALE PG2UN201
Portland NATURALE PG2UN301
Silicon NATURALE PG2UN401

60,3x60,3 cm - 24"x24"
Lime NATURALE PGWUN00P
Concrete NATURALE PGWUN10P
Cement NATURALE PGWUN20P
Portland NATURALE PGWUN30P
Silicon NATURALE PGWUN40P
Concrete STRUTT* PGWUN15P
Cement STRUTT* PGWUN25P
Portland STRUTT* PGWUN35P
Silicon STRUTT* PGWUN45P

GRES A MASSA COLORATA_COLOURED-BODY STONEWARE **20 mm**



60x60 cm Rect - 24"x24"
Cement STRUTTURATO* PGWUN29
Portland STRUTTURATO* PGWUN39
60,3x60,3 cm - 24"x24"
Cement STRUTTURATO* PGWUN28
Portland STRUTTURATO* PGWUN38

* Protezione antibatterica non presente_No antimicrobial protectio_Der Antibakterielle Schutz nicht vorhanden_Protection antibactérienne pas présente

Urbanature

DECORI_DECORS

GRES PORCELLANATO LAMINATO_LAMINATED PORCELAIN STONEWARE **Zero.3**

LIME	CONCRETE	CEMENT	PORTLAND	SILICON
URBAN STRIPES* 50x100 cm Rect - 19 ¹ / ₂ "x39" ± 3 mm PZ9UNS0	URBAN STRIPES* 50x100 cm Rect - 19 ¹ / ₂ "x39" ± 3 mm PZ9UNS1	URBAN STRIPES* 50x100 cm Rect - 19 ¹ / ₂ "x39" ± 3 mm PZ9UNS2	URBAN STRIPES* 50x100 cm Rect - 19 ¹ / ₂ "x39" ± 3 mm PZ9UNS3	URBAN STRIPES* 50x100 cm Rect - 19 ¹ / ₂ "x39" ± 3 mm PZ9UNS4

URBAN LEAVES 1* 50x100 cm Rect - 19 ¹ / ₂ "x39" ± 3 mm PZ9UNL1	URBAN LEAVES 2* 50x100 cm Rect - 19 ¹ / ₂ "x39" ± 3 mm PZ9UNL2

URBAN TWEED 1 50x100 cm Rect - 19 ¹ / ₂ "x39" ± 3 mm PZ9UNT1	URBAN TWEED 2 50x100 cm Rect - 19 ¹ / ₂ "x39" ± 3 mm PZ9UNT2

URBAN STRIPES, URBAN LEAVES 1, URBAN LEAVES 2, URBAN TWEED 1, URBAN TWEED 2:

Posare solo a parete_Recommended only for wall applications_Nur an der Wand verlegen_Recommandé seulement pour les revêtements

* Sviluppato su 2 soggetti, venduto solo a scatole complete_Developed on 2 patterns, full boxes order only_Paarweise, nur als komplette Verpackung erhältlich_Developpé sur 2 éléments, vendu uniquement en boîtes complètes

Urbanature

DECORI_DECORS

GRES A MASSA COLORATA_COLOURED-BODY STONEWARE

LIME	CONCRETE	CEMENT	PORTLAND	SILICON
URBAN STEEL 60x60 cm Rect - 24"x24" ± 9,5 mm PGWUNS0	URBAN STEEL 60x60 cm Rect - 24"x24" ± 9,5 mm PGWUNS1	URBAN STEEL 60x60 cm Rect - 24"x24" ± 9,5 mm PGWUNS2	URBAN STEEL 60x60 cm Rect - 24"x24" ± 9,5 mm PGWUNS3	URBAN STEEL 60x60 cm Rect - 24"x24" ± 9,5 mm PGWUNS4

URBAN WAVY 15x60 cm Rect - 6"x24" ± 9,5 mm PG1UN00	URBAN WAVY 15x60 cm Rect - 6"x24" ± 9,5 mm PG1UN10	URBAN WAVY 15x60 cm Rect - 6"x24" ± 9,5 mm PG1UN20	URBAN WAVY 15x60 cm Rect - 6"x24" ± 9,5 mm PG1UN30	URBAN WAVY 15x60 cm Rect - 6"x24" ± 9,5 mm PG1UN40

MOSAICO 16 PEZZI 30x30 cm Rect - 12"x12" ± 9,5 mm PGZUN00	MOSAICO 16 PEZZI 30x30 cm Rect - 12"x12" ± 9,5 mm PGZUN10	MOSAICO 16 PEZZI 30x30 cm Rect - 12"x12" ± 9,5 mm PGZUN20	MOSAICO 16 PEZZI 30x30 cm Rect - 12"x12" ± 9,5 mm PGZUN30	MOSAICO 16 PEZZI 30x30 cm Rect - 12"x12" ± 9,5 mm PGZUN40

LIME	CEMENT	PORTLAND	SILICON
URBAN WOOD* 45x90 cm Rect - 18"x36" ± 9,5 mm PGHUN04	URBAN WOOD* 45x90 cm Rect - 18"x36" ± 9,5 mm PGHUN24	URBAN WOOD* 45x90 cm Rect - 18"x36" ± 9,5 mm PGHUN34	URBAN WOOD* 45x90 cm Rect - 18"x36" ± 9,5 mm PGHUN44

CONCRETE	PORTLAND
URBAN TEXTURE* 30x60 cm Rect - 12"x24" ± 9,5 mm PG-UN13	URBAN TEXTURE* 6x60 cm Rect - 2 ³ / ₈ "x24" ± 9,5 mm PGTUN13
URBAN TEXTURE* 30x60 cm Rect - 12"x24" ± 9,5 mm PG-UN33	URBAN TEXTURE* 6x60 cm Rect - 2 ³ / ₈ "x24" ± 9,5 mm PGTUN33

* Protezione antibatterica non presente_No antimicrobial protectio_Der Antibakterielle Schutz nicht vorhanden_Protection antibactérienne pas présente



Possibilità di utilizzo a pavimento in interni residenziali_Suitable for floor residential interiors_Es ist möglich die Boden- verlegung in Wohn- ambienten_Possibilité d'utilisation au sol dans les intérieurs résidentiels

Urbanature

PEZZI SPECIALI_TRIM PIECES

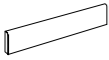
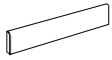
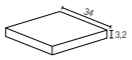
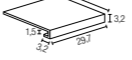
GRES A MASSA COLORATA_COLOURED-BODY STONEWARE

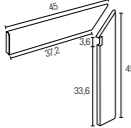
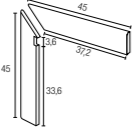

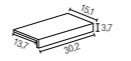
			
BATTISCOPA 10x60 cm Rect - 4"x24" ± 10 mm NATURALE	BATTISCOPA 10x60,3 cm Rect - 4"x24" ± 10 mm NATURALE	ANGOLO GRADONE A COSTA RETTA 34x34 cm Rect - 13.39"x13.39" ± 9,5 mm NATURALE	GRADONE A COSTA RETTA 30x34 cm Rect - 12"x13.39" ± 9,5 mm NATURALE
LIME PGRUNR0	PGRUN00	PGEUN01	PGEUN00
CONCRETE PGRUNR1	PGRUN10	PGEUN11	PGEUN10
CEMENT PGRUNR2	PGRUN20	PGEUN21	PGEUN20
PORTLAND PGRUNR3	PGRUN30	PGEUN31	PGEUN30
SILICON PGRUNR4	PGRUN40	PGEUN41	PGEUN40

				
BATTISCOPA SCALA DX (kit 2 pezzi) 10x45 cm - 4"x18" ± 10 mm NATURALE	BATTISCOPA SCALA SX (kit 2 pezzi) 10x45 cm - 4"x18" ± 10 mm NATURALE	RACCORDO* 1x30 cm Rect - 3/8"x12" NATURALE	ANGOLO RACCORDO* 1x1 cm - 3/8"x3/8" NATURALE	ELEMENTO "L"*** 15x30x4 cm Rect - 6"x12"x1.915" ± 9,5 mm STRUTTURATO
LIME PGZUN0D	PGZUN0S	PGZUNR0	PGZUN0A	/
CONCRETE PGZUN1D	PGZUN1S	PGZUNR1	PGZUN1A	PGZUNA1
CEMENT PGZUN2D	PGZUN2S	PGZUNR2	PGZUN2A	PGZUNA2
PORTLAND PGZUN3D	PGZUN3S	PGZUNR3	PGZUN3A	PGZUNA3
SILICON PGZUN4D	PGZUN4S	PGZUNR4	PGZUN4A	PGZUNA4

* Posare solo all'interno_Strictly for interiors_Nur im Innenraum zu verlegen_Poser seulement à l'intérieur

** Protezione antibatterica non presente_No antimicrobial protectio_Der Antibakterielle Schutz nicht vorhanden_Protection antibactérienne pas présente

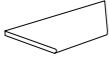
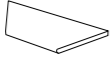
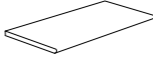
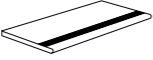
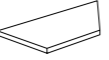
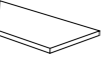
GRES A MASSA COLORATA_COLOURED-BODY STONEWARE 20 mm

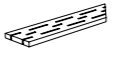
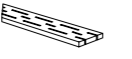
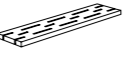
					
COSTA TORO ANGOLARE DX 30x60 cm Rect - 12"x24" STRUTTURATO	COSTA TORO ANGOLARE SX 30x60 cm Rect - 12"x24" STRUTTURATO	COSTA TORO 30x60 cm Rect - 12"x24" STRUTTURATO	COSTA TORO GRIP 30x60 cm Rect - 12"x24" STRUTTURATO	COSTA RETTA ANGOLARE DX 30x60 cm Rect - 12"x24" STRUTTURATO	COSTA RETTA ANGOLARE SX 30x60 cm Rect - 12"x24" STRUTTURATO
CEMENT PGDUNK4	PGDUNK2	PGDUNF2	PGDUNJ2	PGDUND4	PGDUND2
PORTLAND PGDUNK5	PGDUNK3	PGDUNF3	PGDUNJ3	PGDUND5	PGDUND3
					
COSTA RETTA 30x60 cm Rect - 12"x24" STRUTTURATO	COSTA RETTA GRIP 30x60 cm Rect - 12"x24" STRUTTURATO	GRIGLIA ANGOLARE DX 15x60 cm Rect - 6"x24" STRUTTURATO	GRIGLIA ANGOLARE SX 15x60 cm Rect - 6"x24" STRUTTURATO	GRIGLIA 15x60 cm Rect - 6"x24" STRUTTURATO	
CEMENT PGDUNC2	PGDUNG2	PGDUNA4	PGDUNA2	PGDUNZ2	
PORTLAND PGDUNC3	PGDUNG3	PGDUNA5	PGDUNA3	PGDUNZ3	







• Venduti solo a scatole complete_Only full boxes sold_Nur volle Karton_Vendus par boîte complete

• Lavorati solo su richiesta_Manufactured only upon special request_Nur auf Anfrage_Seulement à la demande

• Per tutti i pz speciali consegna 30 gg_For all trim pieces 30 days delivery_Formteile haben 30 Tage lieferzeit_Livraison en 30 jours pour toutes les pièces spéciales

Urbanature

IMBALLAGGI E PESI_PACKINGS AND WEIGHTS

DESCRIZIONE Description	± mm	FORMATI Sizes	SCATOLA_Box				PALLET		
									
FONDO NATURALE	3,5	100x300 RECT	1	25,35	3	-	20	507	60
FONDO NATURALE	3,5	100x100 RECT	3	24,1	3	-	25	602,5	75
FONDO NATURALE	3,5	50x100 RECT	5	20	2,5	-	32	640	80
FONDO NATURALE / EXT	9,5	90x90 RECT	2	34,6	1,62	-	25	865	40,5
FONDO NATURALE	9,5	45x90 RECT	3	25,9	1,215	-	30	777	36,5
FONDO NATURALE	9,5	22,5x90 RECT	4	17,3	0,81	-	44	760	35,6
FONDO NATURALE	9,5	60x60 RECT	4	31,8	1,44	-	32	1018	46,1
FONDO NATURALE	9,5	60,3x60,3	4	31,8	1,454	-	32	1018	46,5
FONDO NATURALE	9,5	30x60 RECT	8	31,8	1,44	-	32	1018	46,1
FONDO NATURALE	8	45,2x45,2	9	-	1,838	-	52	-	95,6
URBAN STRIPES	3	50x100 RECT	2	7	1	-	-	-	-
URBAN LEAVES	3	50x100 RECT	2	7	1	-	-	-	-
URBAN TWEED	3	50x100 RECT	2	7	1	-	-	-	-
URBAN STEEL	9,5	60x60 RECT	2	15,9	0,72	-	20	318	14,4
URBAN WAVY	9,5	15x60 RECT	4	7,9	0,36	-	48	379	17,3
MOSAICO 16 PZ	9,5	30x30 RECT	4	7,2	0,36	-	78	562	28,1
URBAN WOOD	9,5	45x90 RECT	2	17,3	0,81	-	15	259	12,2
URBAN WOOD LISTONE	9,5	22,5x90 RECT	2	8,6	0,405	-	45	389	18,2
URBAN TEXTURE	9,5	30x60 RECT	2	8	0,36	-	128	1024	46,1
LISTELLO URBAN TEXTURE	9,5	6x60 RECT	4	3	0,144	-	-	-	-
RACCORDO NATURALE	-	1x30	8	0,8	0,024	-	-	-	-
ANGOLO RACCORDO NATURALE	-	1x1	10	0,07	0,001	-	-	-	-
BATTISCOPA NATURALE	10	10x60 RECT	12	15,48	0,72	7,20	60	928,80	43,20
BATTISCOPA NATURALE	10	10x60,3	16	20	0,965	9,648	48	960	46,31
BATTISCOPA SCALA NATURALE	10	10x45	5	8,5	0,425	-	-	-	-
GRADONE A COSTA RETTA NATURALE	9,5	30x34	6	17,1	0,612	-	30	513	18,4
ANGOLO GRADONE A COSTA RETTA NATURALE	9,5	34x34	2	6,3	0,231	-	48	301	11,1
ELEMENTO "L" STRUTTURATO	9,5	15x30x4	8	9	0,36	2,4	48	432	17,3
FONDO STRUTTURATO	20	60x60 RECT	2	33,6	0,720	-	32	1075,2	23,04
FONDO STRUTTURATO	20	60,3x60,3	2	33,5	0,727	-	32	1072	23,27
COSTA TORO STRUTTURATO	20	30x60 RECT	1	8,125	0,180	-	100	812,5	18
ANGOLO COSTA TORO STRUTTURATO	20	30x60 RECT	1	6,10	0,135	-	100	610	13,50
COSTA TORO GRIP STRUTTURATO	20	30x60 RECT	1	8,125	0,180	-	100	812,5	18
COSTA RETTA STRUTTURATO	20	30x60 RECT	1	8,125	0,180	-	100	812,5	18
ANGOLO COSTA RETTA STRUTTURATO	20	30x60 RECT	1	6,10	0,135	-	100	610	13,50
COSTA RETTA GRIP STRUTTURATO	20	30x60 RECT	1	8,125	0,180	-	100	812,5	18
GRIGLIA STRUTTURATO	20	15x60 RECT	2	8	0,18	-	100	800	18
ANGOLO GRIGLIA STRUTTURATO	20	15x60 RECT	2	7	0,157	-	100	700	15,75



Effetto marmo



Marble look



RIVESTIMENTO / WALL - Marquina Black Lux 120x260 cm Rect - 48"x102"
 PAVIMENTO / FLOOR - Statuario White Lux 120x120 cm Rect - 48"x48"

Eternity



STATUARIO WHITE



ARABESQUE PEARL



BREACH GREY

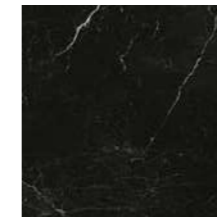

MARQUINA BLACK

GRES PORCELLANATO LAMINATO_LAMINATED PORCELAIN STONEWARE **Zero.3**



± 6 mm



120x260 cm Rect
48"x102"

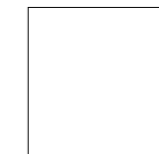

120x120 cm Rect
48"x48"

GRES A MASSA COLORATA_COLOURED-BODY STONEWARE



± 9,5 mm



60x120 cm Rect
24"x48"



60x60 cm Rect
24"x24"



30x60 cm Rect
12"x24"



RIVESTIMENTO / WALL Breach Grey Lux 120x260 cm Rect - 48"x102" _Marquina Black Lux 120x260 cm Rect - 48"x102"
PAVIMENTO / FLOOR Breach Grey Lux 120x120 cm Rect - 48"x48"



RIVESTIMENTO / WALL Statuario White Lux 120x260 cm Rect - 48"x102"_Statuario White Lux Bookmatch 120x260 cm Rect - 48"x102"
PAVIMENTO / FLOOR Statuario White Soft 120x260 cm Rect - 48"x102"



RIVESTIMENTO / WALL Arabesque Pearl Lux 120x260 cm Rect - 48"x102"
PAVIMENTO / FLOOR Marquina Black Soft 120x120 cm Rect - 48"x48"



RIVESTIMENTO / WALL Arabesque Pearl Lux Bookmatch 120x260 cm Rect - 48"x102"
PAVIMENTO / FLOOR Arabesque Pearl Lux 120x120 cm Rect - 48"x48"



PAVIMENTO / FLOOR Chevron Statuario White Soft 9,5x54 cm Rect - 3³/₄"x21¹/₄"

Eternity

PROTECT
ANTIBATTERICO - ANTIMICROBIAL

STATUARIO WHITE



ARABESQUE PEARL



BREACH GREY



MARQUINA BLACK



Eternity

GRES PORCELLANATO LAMINATO_LAMINATED PORCELAIN STONEWARE **Zero.3**

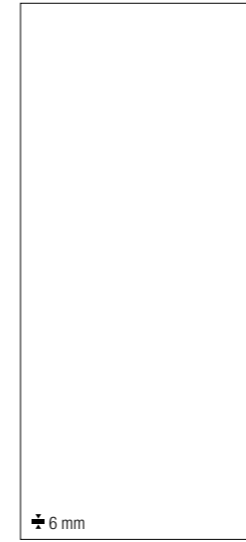

120x260 cm Rect - 48"x102"

Statuario White SOFT PZ6EN20
Arabesque Pearl SOFT PZ6EN00
Breach Grey SOFT PZ6EN10
Marquina Black SOFT PZ6EN30
Statuario White LUX PZ6EN25
Arabesque Pearl LUX PZ6EN05
Breach Grey LUX PZ6EN15
Marquina Black LUX PZ6EN35

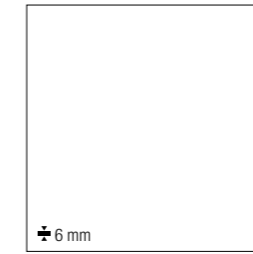

120x120 cm Rect - 48"x48"

Statuario White SOFT PZ8EN20
Arabesque Pearl SOFT PZ8EN00
Breach Grey SOFT PZ8EN10
Marquina Black SOFT PZ8EN30
Statuario White LUX PZ8EN25
Arabesque Pearl LUX PZ8EN05
Breach Grey LUX PZ8EN15
Marquina Black LUX PZ8EN35

GRES A MASSA COLORATA_COLOURED-BODY STONEWARE

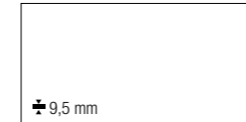

60x120 cm Rect - 24"x48"

Statuario White SOFT PGXEN20
Arabesque Pearl SOFT PGXEN00
Breach Grey SOFT PGXEN10
Marquina Black SOFT PGXEN30
Statuario White LUX PGXEN25
Arabesque Pearl LUX PGXEN05
Breach Grey LUX PGXEN15
Marquina Black LUX PGXEN35



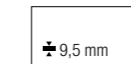

60x60 cm Rect - 24"x24"

Statuario White SOFT PGWEN20
Arabesque Pearl SOFT PGWEN00
Breach Grey SOFT PGWEN10
Marquina Black SOFT PGWEN30
Statuario White LUX PGWEN25
Arabesque Pearl LUX PGWEN05
Breach Grey LUX PGWEN15
Marquina Black LUX PGWEN35





30x60 cm Rect - 12"x24"

Statuario White SOFT PGVEN20
Arabesque Pearl SOFT PGVEN00
Breach Grey SOFT PGVEN10
Marquina Black SOFT PGVEN30
Statuario White LUX PGVEN25
Arabesque Pearl LUX PGVEN05
Breach Grey LUX PGVEN15
Marquina Black LUX PGVEN35

DESTINAZIONI D'USO_INTENDED USE: SOFT / LUX  

DATI TECNICI_TECHNICAL DATA:

GRES PORCELLANATO LAMINATO LAMINATED PORCELAIN STONEWARE	GRES A MASSA COLORATA COLOURED-BODY STONEWARE
6 mm	9,5 mm
 ANSI A326.3: DCOF ≥ 0.42 Soft	ANSI A326.3: DCOF ≥ 0.42 Soft
 ANSI A137.3: V2	ANSI A137.1: V2
PROTECT ANTIBATTERICO - ANTIMICROBIAL	PROTECT ANTIBATTERICO - ANTIMICROBIAL

Eternity

DECORI_DECORS

GRES PORCELLANATO LAMINATO_LAMINATED PORCELAIN STONEWARE **Zero.3**

STATUARIO WHITE BOOKMATCH LUX A+B



LUX A
120x260 cm Rect - 48"x102"
± 6 mm
PZ6ENA2

LUX B
120x260 cm Rect - 48"x102"
± 6 mm
PZ6ENB2

ARABESQUE PEARL BOOKMATCH LUX A+B



LUX A
120x260 cm Rect - 48"x102"
± 6 mm
PZ6ENA0

LUX B
120x260 cm Rect - 48"x102"
± 6 mm
PZ6ENB0

L'immagine è puramente indicativa. La grafica di bookmatch può presentare discontinuità di vena nel passaggio tra le lastre, al pari del materiale naturale. Eventuali differenze fino a 1,5 cm sono dunque da considerarsi caratteristica del prodotto. The picture is purely illustrative. The graphic design of bookmatch may result in discontinuities in the veining between panels, as with the natural material. Discontinuities of up to 1.5 cm are not defects, but are characteristic of the product. Die Abbildung ist rein indikativ. Die Grafik Bookmatch kann, wie beim natürlichen Material, Unterbrechungen in der Maserung beim Übergang zwischen den Platten aufweisen. Eventuelle Unterschiede bis zu 1,5 cm gelten daher als produkttypisch. L'image est purement indicative. Le graphisme de bookmatch peut présenter une discontinuité de veine lors du passage d'une plaque à une autre, comme le matériau naturel. Les différences éventuelles jusqu'à 1,5 mm doivent donc être considérées comme une caractéristique du produit.

GRES A MASSA COLORATA_COLOURED-BODY STONEWARE

STATUARIO WHITE



ANGOLO CLASSIC 1 LUX
(Statuario White, Marquina Black)
60x60 cm Rect - 24"x24"
± 9,5 mm
PGWENA1



FASCIA CLASSIC 1 LUX
(Statuario White, Marquina Black)
60x60 cm Rect - 24"x24"
± 9,5 mm
PGWENF1

MARQUINA BLACK



ANGOLO CLASSIC 2 LUX
(Marquina Black - Statuario White)
60x60 cm Rect - 24"x24"
± 9,5 mm
PGWENA2



FASCIA CLASSIC 2 LUX
(Marquina Black - Statuario White)
60x60 cm Rect - 24"x24"
± 9,5 mm
PGWENF2

ANGOLO CLASSIC 1, FASCIA CLASSIC 1, ANGOLO CLASSIC 2, FASCIA CLASSIC 2:

Possibilità di utilizzo a pavimento in interni_Suitable for interiors floor_Möglichkeit der Verwendung als Boden in Innenbereichen_Possibilité d'utilisation pour les sols à l'intérieur.

Eternity

DECORI_DECORS

GRES A MASSA COLORATA_COLOURED-BODY STONEWARE

STATUARIO WHITE



MOSAICO 36 SOFT
30x30 cm Rect - 12"x12"
± 9,5 mm
PGZEN62



MOSAICO KUBIK LUX
17x29,2 cm Rect - 6^{5/8}"x11^{1/2}"
± 9,5 mm
PGZENK2



CHEVRON SOFT
9,5x54 cm Rect - 3^{3/4}"x21^{1/4}"
± 9,5 mm
PGZENC2



LISTELLO LUX
7x60 cm Rect - 2^{3/4}"x24"
± 9,5 mm
PGZENL2



QUADRATO LUX
7x70 cm Rect - 2^{3/4}"x2^{3/4}"
± 9,5 mm
PGZENQ2



MOSAICO GEMS B LUX
(Statuario White, Marquina Black)
30x30 cm Rect - 12"x12"
± 9,5 mm
PGZEN51

ARABESQUE PEARL

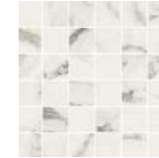

MOSAICO 36 SOFT
30x30 cm Rect - 12"x12"
± 9,5 mm
PGZEN60



MOSAICO KUBIK LUX
17x29,2 cm Rect - 6^{5/8}"x11^{1/2}"
± 9,5 mm
PGZENK0



CHEVRON SOFT
9,5x54 cm Rect - 3^{3/4}"x21^{1/4}"
± 9,5 mm
PGZENC0



LISTELLO LUX
7x60 cm Rect - 2^{3/4}"x24"
± 9,5 mm
PGZENL0



QUADRATO LUX
7x70 cm Rect - 2^{3/4}"x2^{3/4}"
± 9,5 mm
PGZENQ0



MOSAICO GEMS A LUX
(Arabesque Pearl, Breach Grey)
30x30 cm Rect - 12"x12"
± 9,5 mm
PGZEN50

BREACH GREY

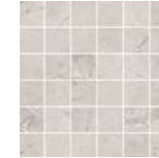

MOSAICO 36 SOFT
30x30 cm Rect - 12"x12"
± 9,5 mm
PGZEN61



MOSAICO KUBIK LUX
17x29,2 cm Rect - 6^{5/8}"x11^{1/2}"
± 9,5 mm
PGZENK1



CHEVRON SOFT
9,5x54 cm Rect - 3^{3/4}"x21^{1/4}"
± 9,5 mm
PGZENC1



LISTELLO LUX
7x60 cm Rect - 2^{3/4}"x24"
± 9,5 mm
PGZENL1



QUADRATO LUX
7x70 cm Rect - 2^{3/4}"x2^{3/4}"
± 9,5 mm
PGZENQ1

MARQUINA BLACK

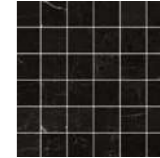

MOSAICO 36 SOFT
30x30 cm Rect - 12"x12"
± 9,5 mm
PGZEN63



MOSAICO KUBIK LUX
17x29,2 cm Rect - 6^{5/8}"x11^{1/2}"
± 9,5 mm
PGZENK3



CHEVRON SOFT
9,5x54 cm Rect - 3^{3/4}"x21^{1/4}"
± 9,5 mm
PGZENC3



LISTELLO LUX
7x60 cm Rect - 2^{3/4}"x24"
± 9,5 mm
PGZENL3



QUADRATO LUX
7x70 cm Rect - 2^{3/4}"x2^{3/4}"
± 9,5 mm
PGZENQ3



CONTEMPORARY LUX
(Statuario White, Marquina Black)
60x60 cm Rect - 24"x24"
± 9,5 mm
PGWENC0

CHEVRON:

Questi formati speciali vengono realizzati con un sistema di taglio a disco senza bisello. L'eventuale presenza di leggere irregolarità del bordo e di scostamenti dimensionali fino ad 1 mm sono da ritenersi conformi. These special formats are produced with a disc cutting system without a bevel. Any slight irregularities of the edge and size deviations of up to 1 mm should be regarded as compliant. Diese Sonderformate werden mit einem Scheibenschnittsystem ohne Fase hergestellt. Eventuelle leichte Unregelmäßigkeiten an der Kante und Größenabweichungen bis zu 1 mm sind als konform anzusehen. Ces formats spéciaux sont réalisés avec un système de découpe à disque sans biseau. L'éventuelle présence de légères irrégularités du bord et de différences de dimension jusqu'à 1 mm est tout à fait conforme.

CHEVRON, MOSAICO 36, LISTELLO, QUADRATO, CONTEMPORARY:

Possibilità di utilizzo a pavimento in interni_Suitable for interiors floor_Möglichkeit der Verwendung als Boden in Innenbereichen_Possibilité d'utilisation pour les sols à l'intérieur.

Eternity

ESEMPI COMPOSIZIONI_TILE LAYOUT EXAMPLES

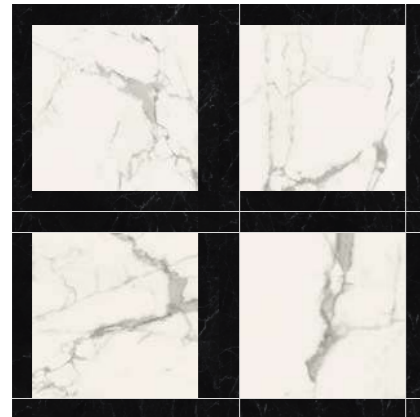

LISTELLO Marquina Black Lux 7x60 cm Rect
 QUADRATO Marquina Black Lux 7x7 cm Rect
 FONDO Statuario White Lux 60x60 cm Rect

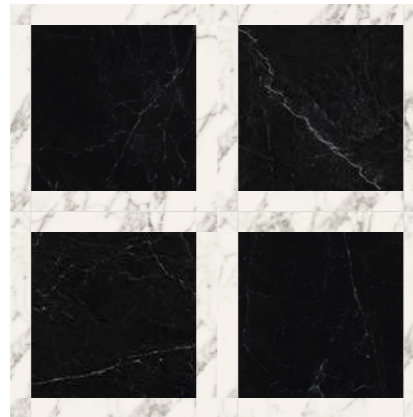

LISTELLO Arabesque Lux 7x60 cm Rect
 QUADRATO Arabesque Lux 7x7 cm Rect
 FONDO Marquina Black Lux 60x60 cm Rect

Per questo tipo di posa Listello e Quadrato Eternity sono abbinabili tra loro e con tutti i fondi 60x60 rettificati delle collezioni a catalogo. For this laying solution Eternity Listello and Quadrato are matchable with the 60x60 rectified of all collections. Bei dieser Art von Verlegung sind Listello und Quadrato Eternity untereinander und mit allen begradigten 60x60 Untergründen der Katalogkollektionen kombinierbar. Pour ce type de pose Listello et Quadrato Eternity sont combinables entre eux et avec tous les fonds de 60x60 rectifiés des collections du catalogue.

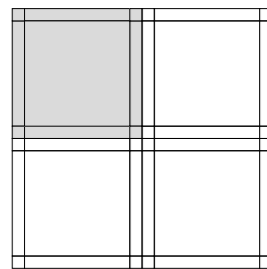

Modulo A_Modulo A_Modul A_Modulo A

4 PEZZI 7x60 (30,68%)
 4 PEZZI 7x7 (3,58%)
 1 PEZZO 60x60 (80,20%)

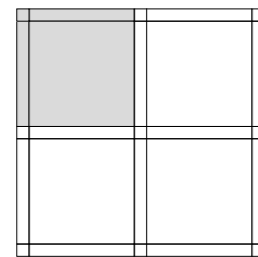

Modulo B_Modulo B_Modul B_Modulo B

2 PEZZI 7x60 (18,71%)
 1 PEZZI 7x7 (1,09%)
 1 PEZZO 60x60 (80,20%)

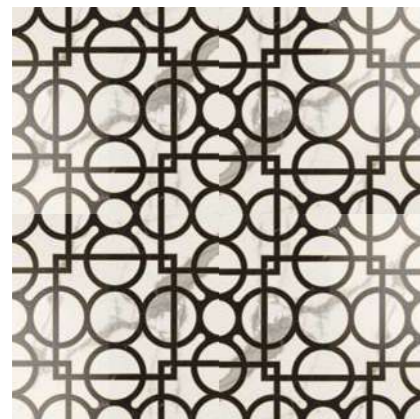

CONTEMPORARY LUX

Esempio composizione 4 pz_4 pz composition example_Beispiel
 Zusammensetzung 4 Stk_Example de composition 4 pièces



FASCIA E ANGOLO CLASSIC 1 LUX

Esempio composizione 6 pz_6 pz composition example_Beispiel
 Zusammensetzung 6 Stk_Example de composition 6 pièces



FASCIA E ANGOLO CLASSIC 2 LUX

Esempio composizione 6 pz_6 pz composition example_Beispiel
 Zusammensetzung 6 Stk_Example de composition 6 pièces

Eternity

PEZZI SPECIALI_TRIM PIECES

GRES A MASSA COLORATA_COLOURED-BODY STONEWARE

BATTISCOPA 10x60 cm Rect - 4"x24" ± 10 mm		GRADINO PLUS* 34x120x4,5 cm Rect - 13 3/8"x48x1 3/4" ± 9,5 mm		GRADINO ANGOLARE PLUS DX* 34x120x4,5 cm Rect - 13 3/8"x48x1 3/4" ± 9,5 mm		GRADINO ANGOLARE PLUS SX* 34x120x4,5 cm Rect - 13 3/8"x48x1 3/4" ± 9,5 mm		
SOFT	LUX*	SOFT	LUX*	SOFT	LUX*	SOFT	LUX*	
STATUARIO WHITE	PGREN20	PGREN25	PGDEN20	PGDEN70	PGDEN21	PGDEN71	PGDEN22	PGDEN72
ARABESQUE PEARL	PGREN00	PGREN05	PGDEN00	PGDEN50	PGDEN01	PGDEN51	PGDEN02	PGDEN52
BREACH GREY	PGREN10	PGREN15	PGDEN10	PGDEN60	PGDEN11	PGDEN61	PGDEN12	PGDEN62
MARQUINA BLACK	PGREN30	PGREN35	PGDEN30	PGDEN80	PGDEN31	PGDEN81	PGDEN32	PGDEN82

* Lavorati solo su richiesta_Manufactured only upon special request_Nur auf Anfrage_Seulement à la demande

IMBALLAGGI E PESI_PACKINGS AND WEIGHTS

DESCRIZIONE Description	± mm	FORMATI Sizes	SCATOLA_Box				PALLET		
FONDO SOFT / LUX	6	120x260 RECT	1	43,10	3,12	-	20	862	62,4
FONDO SOFT / LUX	6	120x120 RECT	2	39,80	2,88	-	25	995	72,0
BOOKMATCH A LUX	6	120x260 RECT	1	43,10	3,12	-	20	862	62,4
BOOKMATCH B LUX	6	120x260 RECT	1	43,10	3,12	-	20	862	62,4
FONDO SOFT / LUX	9,5	60x120 RECT	2	31,8	1,44	-	36	1145	51,8
FONDO SOFT / LUX	9,5	60x60 RECT	4	31,8	1,44	-	32	1018	46,1
FONDO SOFT / LUX	9,5	30x60 RECT	8	31,8	1,44	-	32	1018	46,1
MOSAICO 36 SOFT	9,5	30x30 RECT	4	7,2	0,36	-	78	562	28,1
MOSAICO KUBIK LUX	9,5	17x29,2 RECT	4	4,1	0,198	-	60	245	11,9
CHEVRON SOFT	9,5	9,5x54 RECT	8	9,2	0,41	-	60	553	24,6
MOSAICO GEMS LUX	9,5	30x30 RECT	4	7,4	0,36	-	48	356	17,3
CONTEMPORARY LUX	9,5	60x60 RECT	4	31,8	1,44	-	32	1018	46,1
ANGOLO CLASSIC 1/2 LUX	9,5	60x60 RECT	4	31,8	1,44	-	-	-	-
FASCIA CLASSIC 1/2 LUX	9,5	60x60 RECT	2	15,9	0,72	-	-	-	-
LISTELLO LUX	9,5	7x60 RECT	16	13,8	0,672	-	40	551	26,9
QUADRATO LUX	9,5	7x7 RECT	16	1,6	0,078	-	456	736	35,8
BATTISCOPA SOFT / LUX	10	10x60 RECT	12	15	0,72	7,2	60	900	43,2
GRADINO PLUS SOFT / LUX	9,5	34x120x4,5	2	33,3	0,816	-	12	399	9,8
GRADINO ANGOLARE PLUS SOFT / LUX	9,5	34x120x4,5	1	16,6	0,408	-	24	399	9,8



Trilogy



CALACATTA WHITE



ONYX LIGHT

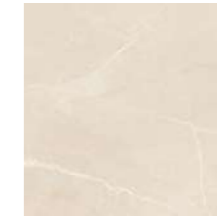

MOON BEIGE



SANDY GREY



SKY SMOKE

GRES PORCELLANATO LAMINATO_LAMINATED PORCELAIN STONEWARE **Zero.3**



± 5,5 mm



100x300 cm Rect
39"x118"



100x100 cm Rect
39"x39"



50x100 cm Rect
19 1/2"x39"

RIVESTIMENTO MONOPOROSA_SINGLE-FIRED WALL TILES



± 10,5 mm



35x100 cm Rect
13 3/4"x39"

GRES A MASSA COLORATA_COLOURED-BODY STONEWARE



± 9,5 mm

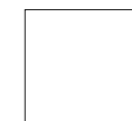

90x90 cm Rect
36"x36"
88x88 cm
34 5/8"x34 5/8"

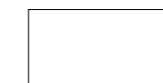

60x120 cm Rect
24"x48"



60x60 cm Rect
24"x24"



30x60 cm Rect
12"x24"

RIVESTIMENTO / WALL Sandy Grey Lux 100x300 cm Rect - 39"x118"
PAVIMENTO / FLOOR Sandy Grey Soft 60x120 cm Rect - 24"x48"



RIVESTIMENTO / WALL Moon Beige Soft 100x300 cm Rect - 39"x118"
 PAVIMENTO / FLOOR Moon Beige Soft 60x60 cm Rect - 24"x24"

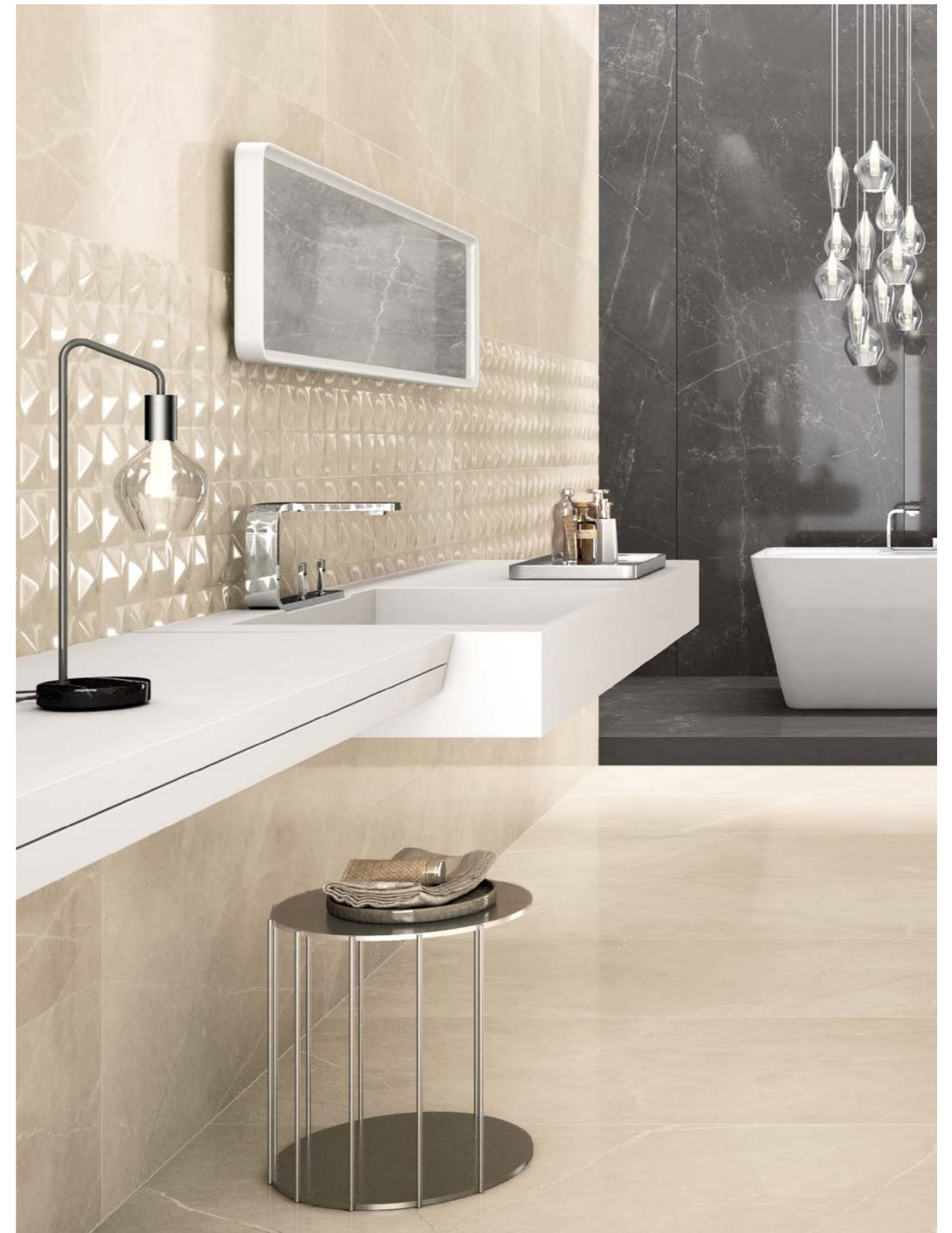

RIVESTIMENTO / WALL Moon Beige 35x100 cm Rect - 13^{3/4}"x39" Fusion Moon Beige 35x100 cm Rect - 13^{3/4}"x39" Sky Smoke Lux 100x300 cm Rect - 39"x118"
 PAVIMENTO / FLOOR Moon Beige Lux 60x120 cm Rect - 24"x48"



RIVESTIMENTO / WALL Calacatta White Lux 100x300 cm Rect - 39"x118"
PAVIMENTO / FLOOR Calacatta White Lux 100x100 cm Rect - 39"x39"



RIVESTIMENTO / WALL Curl Calacatta White 35x100 cm - 13^{3/4}"x39"



RIVESTIMENTO / WALL Onyx Light Soft 100x300 cm Rect - 39"x118"
PAVIMENTO / FLOOR Onyx Light Soft 100x100 cm Rect - 39"x39"



PAVIMENTO / FLOOR Sandy Grey Chevron Soft 9,5x54 cm Rect - 3³/₄"x21¹/₄"



RIVESTIMENTO / WALL Sky Smoke Mosaico Freccia 30x34,5 cm Rect - 12"x13³/₄"

Trilogy

PROTECT
ANTIBATTERICO - ANTIMICROBIAL

CALACATTA WHITE



ONYX LIGHT



MOON BEIGE





SANDY GREY





SKY SMOKE



DESTINAZIONI D'USO_INTENDED USE: SOFT / LUX  

DATI TECNICI_TECHNICAL DATA:

GRES PORCELLANATO LAMINATO LAMINATED PORCELAIN STONEWARE	RIVESTIMENTO MONOPOROSA SINGLE-FIRED WALL TILES	GRES A MASSA COLORATA COLOURED-BODY STONEWARE
± 5,5 mm	10,5 mm	9,5 mm
 ANSI A326.3: DCOF ≥ 0.42 Soft	/	ANSI A326.3: DCOF ≥ 0.42 Soft
 ANSI A137.3: V2	ANSI A137.1: V2	ANSI A137.1: V2
PROTECT ANTIBATTERICO - ANTIMICROBIAL Soft	/	PROTECT ANTIBATTERICO - ANTIMICROBIAL Soft

Trilogy

GRES PORCELLANATO LAMINATO_LAMINATED PORCELAIN STONEWARE **Zero.3**



100x300 cm Rect - 39"x118"

Calacatta White SOFT	PZ7TY00
Onyx Light SOFT	PZ7TY20
Moon Beige SOFT	PZ7TY10
Sandy Grey SOFT	PZ7TY30
Sky Smoke SOFT	PZ7TY40
Calacatta White LUX	PZ7TYX0
Onyx Light LUX	PZ7TYX2
Moon Beige LUX	PZ7TYX1
Sandy Grey LUX	PZ7TYX3
Sky Smoke LUX	PZ7TYX4

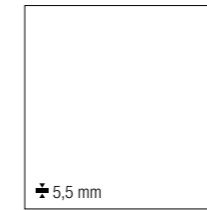

100x100 cm Rect - 39"x39"

Calacatta White SOFT	PZ8TY00
Onyx Light SOFT	PZ8TY20
Moon Beige SOFT	PZ8TY10
Sandy Grey SOFT	PZ8TY30
Sky Smoke SOFT	PZ8TY40
Calacatta White LUX	PZ8TYX0
Onyx Light LUX	PZ8TYX2
Moon Beige LUX	PZ8TYX1
Sandy Grey LUX	PZ8TYX3
Sky Smoke LUX	PZ8TYX4

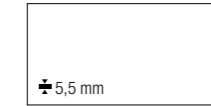

50x100 cm Rect - 19 1/2"x39"

Calacatta White SOFT	PZ9TY00
Onyx Light SOFT	PZ9TY20
Moon Beige SOFT	PZ9TY10
Sandy Grey SOFT	PZ9TY30
Sky Smoke SOFT	PZ9TY40
Calacatta White LUX	PZ9TYX0
Onyx Light LUX	PZ9TYX2
Moon Beige LUX	PZ9TYX1
Sandy Grey LUX	PZ9TYX3
Sky Smoke LUX	PZ9TYX4

GRES A MASSA COLORATA_COLOURED-BODY STONEWARE



90x90 cm Rect - 36"x36"

Calacatta White SOFT	PGGTY01
Moon Beige SOFT	PGGTY11
Sandy Grey SOFT	PGGTY31
88x88 cm - 34 5/8"x34 5/8"	
Calacatta White LUX	PGGTYL01
Moon Beige LUX	PGGTYL11
Sandy Grey LUX	PGGTYL31

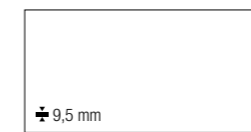

60x120 cm Rect - 24"x48"

Calacatta White SOFT	PGXTY02
Onyx Light SOFT	PGXTY22
Moon Beige SOFT	PGXTY12
Sandy Grey SOFT	PGXTY32
Sky Smoke SOFT	PGXTY42
Calacatta White LUX	PGXTY02
Onyx Light LUX	PGXTY22
Moon Beige LUX	PGXTY12
Sandy Grey LUX	PGXTY32
Sky Smoke LUX	PGXTY42

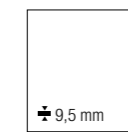

60x60 cm Rect - 24"x24"

Calacatta White SOFT	PGWTY05
Onyx Light SOFT	PGWTY25
Moon Beige SOFT	PGWTY15
Sandy Grey SOFT	PGWTY35
Sky Smoke SOFT	PGWTY45
Calacatta White LUX	PGWTY05
Onyx Light LUX	PGWTY25
Moon Beige LUX	PGWTY15
Sandy Grey LUX	PGWTY35
Sky Smoke LUX	PGWTY45

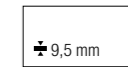

30x60 cm Rect - 12"x24"

Calacatta White SOFT	PGTY05
Onyx Light SOFT	PGTY25
Moon Beige SOFT	PGTY15
Sandy Grey SOFT	PGTY35
Sky Smoke SOFT	PGTY45
Calacatta White LUX	PGTY05
Onyx Light LUX	PGTY25
Moon Beige LUX	PGTY15
Sandy Grey LUX	PGTY35
Sky Smoke LUX	PGTY45

RIVESTIMENTO MONOPOROSA_SINGLE-FIRED WALL TILES

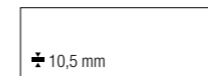

35x100 cm Rect - 13 3/4"x39"

Calacatta White	PBFTY002
Onyx Light	PBFTY202
Moon Beige	PBFTY102
Sandy Grey	PBFTY302
Sky Smoke	PBFTY402

SOFT:

Protezione antibatterica presente_Integrated antibacterial protection_Antibakterieller Schutz vorhanden_Protection antibactérienne présente

Trilogy

DECORI_DECORS

GRES A MASSA COLORATA_COLOURED-BODY STONEWARE

CALACATTA WHITE

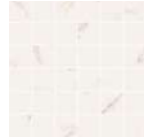

MOSAICO 36 SOFT
30x30 cm Rect - 12"x12"
± 9,5 mm
PGZTY00

ONYX LIGHT



MOSAICO 36 SOFT
30x30 cm Rect - 12"x12"
± 9,5 mm
PGZTY00

MOON BEIGE



MOSAICO 36 SOFT
30x30 cm Rect - 12"x12"
± 9,5 mm
PGZTY10

SANDY GREY

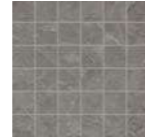

MOSAICO 36 SOFT
30x30 cm Rect - 12"x12"
± 9,5 mm
PGZTY30

SKY SMOKE

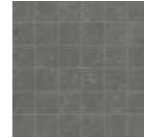

MOSAICO 36 SOFT
30x30 cm Rect - 12"x12"
± 9,5 mm
PGZTY40



MOSAICO 36 LUX
29x29 cm Rect - 11 1/2"x11 1/2"
± 9,5 mm
PGZTYL0



MOSAICO 36 LUX
29x29 cm Rect - 11 1/2"x11 1/2"
± 9,5 mm
PGZTYL2



MOSAICO 36 LUX
29x29 cm Rect - 11 1/2"x11 1/2"
± 9,5 mm
PGZTYL1



MOSAICO 36 LUX
29x29 cm Rect - 11 1/2"x11 1/2"
± 9,5 mm
PGZTYL3

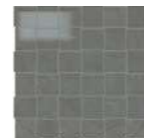

MOSAICO 36 LUX
29x29 cm Rect - 11 1/2"x11 1/2"
± 9,5 mm
PGZTYL4



MOSAICO 72 1 LUX
30x30 cm Rect - 12"x12"
± 9,5 mm
PGZTY71



MOSAICO 72 2 LUX
30x30 cm Rect - 12"x12"
± 9,5 mm
PGZTY72



MOSAICO FRECCIA
30x34,5 cm Rect - 12"x13 3/4"
± 9,5 mm
PGZTYE0



MOSAICO FRECCIA
30x34,5 cm Rect - 12"x13 3/4"
± 9,5 mm
PGZTYE2



MOSAICO FRECCIA
30x34,5 cm Rect - 12"x13 3/4"
± 9,5 mm
PGZTYE1



MOSAICO FRECCIA
30x34,5 cm Rect - 12"x13 3/4"
± 9,5 mm
PGZTYE3

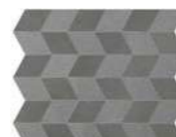

MOSAICO FRECCIA
30x34,5 cm Rect - 12"x13 3/4"
± 9,5 mm
PGZTYE4



CHEVRON SOFT
9,5x54 cm Rect - 3 3/4"x21 1/4"
± 9,5 mm
PGZTYC0



CHEVRON SOFT
9,5x54 cm Rect - 3 3/4"x21 1/4"
± 9,5 mm
PGZTYC2



CHEVRON SOFT
9,5x54 cm Rect - 3 3/4"x21 1/4"
± 9,5 mm
PGZTYC1



CHEVRON SOFT
9,5x54 cm Rect - 3 3/4"x21 1/4"
± 9,5 mm
PGZTYC3



CHEVRON SOFT
9,5x54 cm Rect - 3 3/4"x21 1/4"
± 9,5 mm
PGZTYC4

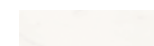

7,5x30 cm Rect - 3"x12 2/3"
± 9,5 mm
PGZTYM01 SOFT



7,5x30 cm Rect - 3"x12 2/3"
± 9,5 mm
PGZTYM21 SOFT



7,5x30 cm Rect - 3"x12 2/3"
± 9,5 mm
PGZTYM11 SOFT



7,5x30 cm Rect - 3"x12 2/3"
± 9,5 mm
PGZTYM31 SOFT



7,5x30 cm Rect - 3"x12 2/3"
± 9,5 mm
PGZTYM41 SOFT

CHEVRON:

Questi formati speciali vengono realizzati con un sistema di taglio a disco senza bisello. L'eventuale presenza di leggere irregolarità del bordo e di scostamenti dimensionali fino ad 1 mm sono da ritenersi conformi. These special formats are produced with a disc cutting system without a bevel. Any slight irregularities of the edge and size deviations of up to 1 mm should be regarded as compliant. Diese Sonderformate werden mit einem Scheibenschrittsystem ohne Fase hergestellt. Eventuelle leichte Unregelmäßigkeiten an der Kante und Größenabweichungen bis zu 1 mm sind als konform anzusehen. Ces formats spéciaux sont réalisés avec une système de découpe à disque sans biseau. L'éventuelle présence de légères irrégularités du bord et de différences de dimension jusqu'à 1 mm est tout à fait conforme.

SOFT:

Protezione antibatterica presente_Integrated antibacterial protection_Antibakterieller Schutz vorhanden_Protection antibactérienne présente

Trilogy

DECORI_DECORS

RIVESTIMENTO MONOPOROSA_SINGLE-FIRED WALL TILES

CALACATTA WHITE



JEWEL
35x100 cm Rect - 13 3/4"x39"
± 10,5 mm
PBFTYJ01

ONYX LIGHT



JEWEL
35x100 cm Rect - 13 3/4"x39"
± 10,5 mm
PBFTYJ21

MOON BEIGE



JEWEL
35x100 cm Rect - 13 3/4"x39"
± 10,5 mm
PBFTYJ11



FUSION
35x100 cm Rect - 13 3/4"x39"
± 10,5 mm
PBFTY052



FUSION
35x100 cm Rect - 13 3/4"x39"
± 10,5 mm
PBFTY252



FUSION
35x100 cm Rect - 13 3/4"x39"
± 10,5 mm
PBFTY152



SWING
35x100 cm Rect - 13 3/4"x39"
± 10,5 mm
PBFTYS0



SWING
35x100 cm Rect - 13 3/4"x39"
± 10,5 mm
PBFTYS2



SWING
35x100 cm Rect - 13 3/4"x39"
± 10,5 mm
PBFTYS1



SWING GLITTER
35x100 cm Rect - 13 3/4"x39"
± 10,5 mm
PBFTYF01



SWING GLITTER
35x100 cm Rect - 13 3/4"x39"
± 10,5 mm
PBFTYF21



SWING GLITTER
35x100 cm Rect - 13 3/4"x39"
± 10,5 mm
PBFTYF11

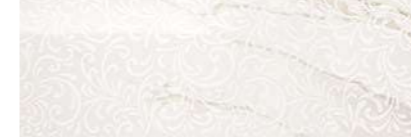

CURL
35x100 cm Rect - 13 3/4"x39"
± 10,5 mm
PBFTYC01



CURL
35x100 cm Rect - 13 3/4"x39"
± 10,5 mm
PBFTYC21



CURL
35x100 cm Rect - 13 3/4"x39"
± 10,5 mm
PBFTYC11



GLAMOUR MIX
35x100 cm Rect - 13 3/4"x39"
± 10,5 mm
PBFTYGO



GLAMOUR MIX
35x100 cm Rect - 13 3/4"x39"
± 10,5 mm
PBFTYG1

GLAMOUR MIX:

Sviluppato su 2 soggetti_Developed on 2 patterns_Paarweise entwickelt_Developpe sur 2 éléments

Trilogy

DECORI_DECORS

RIVESTIMENTO MONOPOROSA_SINGLE-FIRED WALL TILES

SANDY GREY



JEWEL
35x100 cm Rect - 13^{3/4}"x39"
± 10,5 mm
PBFTYJ31



FUSION
35x100 cm Rect - 13^{3/4}"x39"
± 10,5 mm
PBFTY352



SWING
35x100 cm Rect - 13^{3/4}"x39"
± 10,5 mm
PBFTYS3



SWING GLITTER
35x100 cm Rect - 13^{3/4}"x39"
± 10,5 mm
PBFTYF31

SKY SMOKE



JEWEL
35x100 cm Rect - 13^{3/4}"x39"
± 10,5 mm
PBFTYJ41



FUSION
35x100 cm Rect - 13^{3/4}"x39"
± 10,5 mm
PBFTY452



SWING
35x100 cm Rect - 13^{3/4}"x39"
± 10,5 mm
PBFTYS4

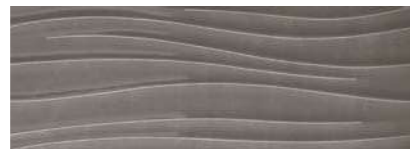

SWING GLITTER
35x100 cm Rect - 13^{3/4}"x39"
± 10,5 mm
PBFTYF41

Trilogy

PEZZI SPECIALI_TRIM PIECES

GRES A MASSA COLORATA_COLOURED-BODY STONEWARE

	BATTISCOPA 10x60 cm Rect - 4"x24" ± 10 mm		GRADINO PLUS* 34x120x4,5 cm Rect - 13 ^{3/8} "x48x1 ^{3/4} " ± 9,5 mm		GRADINO ANGOLARE PLUS DX* 34x120x4,5 cm Rect - 13 ^{3/8} "x48x1 ^{3/4} " ± 9,5 mm		GRADINO ANGOLARE PLUS SX* 34x120x4,5 cm Rect - 13 ^{3/8} "x48x1 ^{3/4} " ± 9,5 mm	
	SOFT	LUX*	SOFT	LUX*	SOFT	LUX*	SOFT	LUX*
CALACATTA WHITE	PGRTY00	PGRTY60	PGDTY00	PGDTY55	PGDTY01	PGDTY56	PGDTY02	PGDTY57
ONYX LIGHT	PGRTY20	PGRTY62	PGDTY20	PGDTY75	PGDTY21	PGDTY76	PGDTY22	PGDTY77
MOON BEIGE	PGRTY10	PGRTY61	PGDTY10	PGDTY65	PGDTY11	PGDTY66	PGDTY12	PGDTY67
SANDY GREY	PGRTY30	PGRTY63	PGDTY30	PGDTY85	PGDTY31	PGDTY86	PGDTY32	PGDTY87
SKY SMOKE	PGRTY40	PGRTY64	PGDTY40	PGDTY95	PGDTY41	PGDTY96	PGDTY42	PGDTY97

* Lavorati solo su richiesta_Manufactured only upon special request_Nur auf Anfrage_Seulement à la demande

RIVESTIMENTO MONOPOROSA_SINGLE-FIRED WALL TILES

	SPIGOLO 1x35 cm Rect - 3/8"x13 ^{3/4} " ± 10 mm		TORELLO 5x35 cm Rect - 2"x13 ^{3/4} " ± 10 mm		ANGOLO ESTERNO TORELLO 2x5 cm - 3/4"x2" ± 10 mm		ALZATA 12,5x35 cm - 5"x13 ^{3/4} " ± 10 mm		ANGOLO ESTERNO ALZATA 2x12,5 cm - 3/4"x5" ± 9 mm	
	PBZTY00	PBZTY01	PBZTY03	PBZTY02	PBZTY04					
CALACATTA WHITE	PBZTY00	PBZTY01	PBZTY03	PBZTY02	PBZTY04					
ONYX LIGHT	PBZTY20	PBZTY21	PBZTY23	PBZTY22	PBZTY24					
MOON BEIGE	PBZTY10	PBZTY11	PBZTY13	PBZTY12	PBZTY14					

IMBALLAGGI E PESI_PACKINGS AND WEIGHTS

DESCRIZIONE Description	± mm	FORMATI Sizes	SCATOLA_Box				PALLET		
FONDO SOFT / LUX	5,5	100x300 ^{RECT}	1	34,5	3	-	13	448,5	39
FONDO SOFT / LUX	5,5	100x100 ^{RECT}	2	23	2	-	25	575	50
FONDO SOFT / LUX	5,5	50x100 ^{RECT}	3	18,9	1,50	-	32	604,8	48
FONDO SOFT	9,5	90x90 ^{RECT}	2	34,6	1,62	-	25	865	40,5
FONDO LUX	9,5	88x88 ^{RECT}	2	33,5	1,549	-	25	839	38,7
FONDO SOFT / LUX	9,5	60x120 ^{RECT}	2	31,8	1,44	-	36	1145	51,8
FONDO SOFT / LUX	9,5	60x60 ^{RECT}	4	31,8	1,44	-	32	1018	46,1
FONDO SOFT / LUX	9,5	30x60 ^{RECT}	8	31,8	1,44	-	32	1018	46,1
MOSAICO 36 SOFT	9,5	30x30 ^{RECT}	4	7,2	0,36	-	78	562	28,1
MOSAICO 36 LUX	9,5	29x29 ^{RECT}	4	7,1	0,336	-	60	428	20,2
MOSAICO FRECCIA	9,5	30x34,5 ^{RECT}	4	9,3	0,414	-	-	-	-
MOSAICO 72 1/2 LUX	9,5	30x30 ^{RECT}	4	7,2	0,36	-	78	562	28,1
CHEVRON SOFT	9,5	9,5x54 ^{RECT}	8	9,2	0,407	-	64	590	26
FONDO SOFT	9,5	7,5x30 ^{RECT}	16	7,6	0,36	-	84	638	30,2
BATTISCOPA SOFT / LUX	10	10x60 ^{RECT}	12	15	0,72	7,20	60	900	43,2
GRADINO PLUS SOFT / LUX	9,5	34x120x4,5	2	33,3	0,816	-	12	399	9,8
GRADINO ANGOLARE PLUS SOFT / LUX	9,5	34x120x4,5	1	16,6	0,408	-	24	399	9,8
FONDO	10,5	35x100 ^{RECT}	3	20,15	1,05	-	28	564,20	29,40
JEWEL	10,5	35x100 ^{RECT}	3	19,80	1,05	-	12	237,6	12,6
FUSION	10,5	35x100 ^{RECT}	3	20,15	1,05	-	28	564,2	29,4
CURL	10,5	35x100 ^{RECT}	3	19,80	1,05	-	12	237,6	12,6
SWING	10,5	35x100 ^{RECT}	3	20,15	1,05	-	26	523,9	27,3
GLITTER	10,5	35x100 ^{RECT}	3	19,80	1,05	-	12	237,6	12,6
GLAMOUR MIX	10,5	35x100 ^{RECT}	2	13,2	0,7	-	18	237,6	12,6
SPIGOLO	10	1x35 ^{RECT}	8	0,80	0,028	-	-	-	-
TORELLO	10	5x35 ^{RECT}	6	1,8	0,105	-	-	-	-
ANGOLO ESTERNO TORELLO	-	2x5	4	0,2	0,004	-	-	-	-
ALZATA	10	12,5x35 ^{RECT}	6	3,6	0,262	-	-	-	-
ANGOLO ESTERNO ALZATA	-	2x12,5	4	0,4	0,01	-	-	-	-

SOFT:

Protezione antibatterica presente_Integrated antibacterial protection_Antibakterieller Schutz vorhanden_Protection antibactérienne présente



Effetto legno



Wood look



Assi d'Alpe



CHALET



BADIA



CIASA



MASO



STUBE

GRES A MASSA COLORATA_COLOURED-BODY STONEWARE



± 9,5 mm

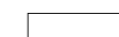

20x90,5 cm
8"x36"



PAVIMENTO / FLOOR Badia 20x90,5 cm - 8"x36"



PAVIMENTO / FLOOR Chalet 20x90,5 cm - 8"x36"



PAVIMENTO / FLOOR Ciasa 20x90,5 cm - 8"x36"

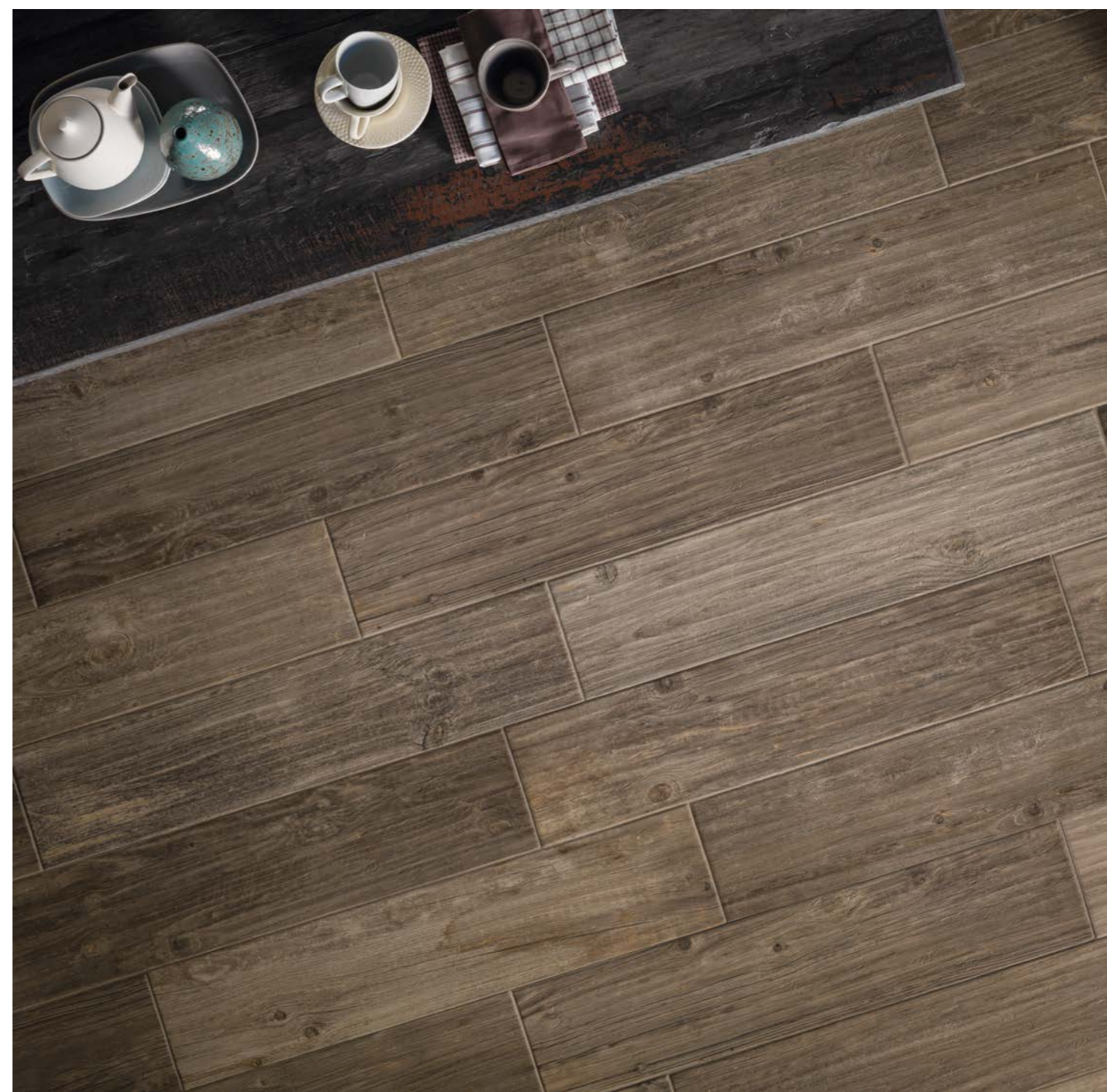

PAVIMENTO / FLOOR Maso 20x90,5 cm - 8"x36"

Assi d'Alpe

CHALET



BADIA



CIASA





MASO



STUBE





DESTINAZIONI D'USO_INTENDED USE: NATURALE   

DATI TECNICI_TECHNICAL DATA:

GRES A MASSA COLORATA
COLOURED-BODY STONEWARE

± 9,5 mm

 DIN 51130: R10
DIN 51097: A
BCR TORTUS: $\mu > 0,40$
ANSI A326.3: DCOF $\geq 0,42$

 ANSI A137.1: V2 Badia, Ciasa, Chalet
V3 Stube, Maso

PROTECT
ANTIBATTERICO - ANTIMICROBIAL

* Per ordini superiori ai 1.000 Mq può essere richiesta la protezione antibatterica con una maggiorazione di 2,5€ netti al Mq. For orders above 1.000 Sqm the anti-bacterial protection may be requested and added, with a €2,50/Sqm net price increase. Sie koennen den antibakterielle Hygieneschutz von nachfragen für alle Aufträge ab 1000 QM, mit einer Preiserhöhung von Euro 2,50/QM netto. Pour commandes supérieures à 1.000 m² vous pouvez demander la protection antibactérienne avec un prix majoré de 2,5 Euro net/m²

Assi d'Alpe

GRES A MASSA COLORATA_COLOURED-BODY STONEWARE

± 9,5 mm

20x90,5 cm - 8"x36"

Chalet NATURALE PG2DA001
Badia NATURALE PG2DA301
Ciasa NATURALE PG2DA201
Maso NATURALE PG2DA401
Stube NATURALE PG2DA101

PEZZI SPECIALI_TRIM PIECES







GRES A MASSA COLORATA_COLOURED-BODY STONEWARE



BATTISCOPA
10x60,3 cm Rect - 4"x24"
± 10 mm
NATURALE

CHALET	PGRDA00
BADIA	PGRDA30
CIASA	PGRDA20
MASO	PGRDA40
STUBE	PGRDA10

IMBALLAGGI E PESI_PACKINGS AND WEIGHTS

DESCRIZIONE Description	± mm	FORMATI Sizes	SCATOLA_Box				PALLET			
										
FONDO NATURALE	9,5	20x90,5	6	23,3	1,086	-	48	1117	52,1	
BATTISCOPA NATURALE	10	10x60,3	16	20	0,966	9,648	48	960	46,387	



Chic Wood



MILK



HONEY



COCO



FOAM



EMBER

GRES A MASSA COLORATA_COLOURED-BODY STONEWARE



± 9,5 mm



20x120 cm Rect
8"x48"



PAVIMENTO / FLOOR Coco 20x120 cm Rect - 8"x48"



PAVIMENTO / FLOOR Milk 20x120 cm Rect - 8"x48"

Chic Wood

PROTECT
ANTIBATTERICO - ANTIMICROBIAL

MILK



HONEY



COCO



FOAM



EMBER





Chic Wood

GRES A MASSA COLORATA_COLOURED-BODY STONEWARE

± 9,5 mm

20x120 cm Rect - 8"x48"

Milk NATURALE PG0CH40
Honey NATURALE PG0CH30
Coco NATURALE PG0CH00
Foam NATURALE PG0CH20
Ember NATURALE PG0CH10

DESTINAZIONI D'USO_INTENDED USE: NATURALE   

DATI TECNICI_TECHNICAL DATA:

GRES A MASSA COLORATA
COLOURED-BODY STONEWARE

± 9,5 mm

 DIN 51130: R10
DIN 51097: B (A+B)
BCR TORTUS: $\mu > 0,40$
ANSI A326.3: DCOF $\geq 0,42$

 ANSI A137.1: V2

PROTECT
ANTIBATTERICO - ANTIMICROBIAL

PEZZI SPECIALI_TRIM PIECES

GRES A MASSA COLORATA_COLOURED-BODY STONEWARE

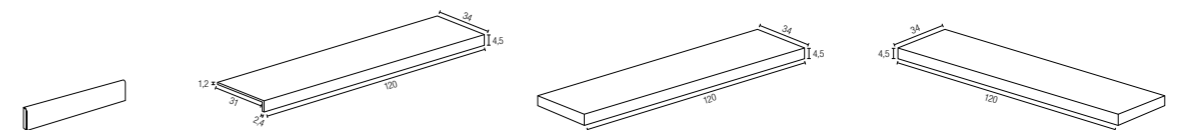

BATTISCOPA
10x60 cm - 4"x24"
± 10 mm
NATURALE







GRADINO BORDO PLUS
34x120x4,5 cm Rect - 13^{3/8}"x48x1^{3/4}"
± 9,5 mm
NATURALE

GRADINO ANGOLARE PLUS DX
34x120x4,5 cm Rect - 13^{3/8}"x48x1^{3/4}"
± 9,5 mm
NATURALE

GRADINO ANGOLARE PLUS SX
34x120x4,5 cm Rect - 13^{3/8}"x48x1^{3/4}"
± 9,5 mm
NATURALE

MILK	PGRCH40	PGDCH40	PGDCH41	PGDCH42
HONEY	PGRCH30	PGDCH30	PGDCH31	PGDCH32
COCO	PGRCH00	PGDCH00	PGDCH01	PGDCH02
FOAM	PGRCH20	PGDCH20	PGDCH21	PGDCH22
EMBER	PGRCH10	PGDCH10	PGDCH11	PGDCH12

IMBALLAGGI E PESI_PACKINGS AND WEIGHTS

DESCRIZIONE Description	± mm	FORMATI Sizes	SCATOLA_Box				PALLET		
									
FONDO NATURALE	9,5	20x120 RECT	5	27,2	1,2	-	24	653	28,8
BATTISCOPA NATURALE	10	10x60 RECT	12	15,48	0,72	7,2	60	928,8	43,2
GRADINO BORDO PLUS NATURALE	9,5	34x120x4,5 RECT	2	33,3	0,816	-	12	399	9,8
GRADINO ANGOLARE PLUS NATURALE	9,5	34x120x4,5 RECT	1	16,6	0,408	-	24	399	9,8



Cross Wood



BONE



BUFF



DUST



CINDER



EBONY

GRES A MASSA COLORATA_COLOURED-BODY STONEWARE 

± 9,5 mm

20x121,5 cm
8"x48"

GRES A MASSA COLORATA_COLOURED-BODY STONEWARE **20 mm** 

± 20 mm

30x120 cm Rect
12"x48"



PAVIMENTO / FLOOR Buff 20x121,5 cm - 8"x48"



PAVIMENTO / FLOOR Bone 20x121,5 cm - 8"x48"



RIVESTIMENTO / WALL Experience 0.3 Nero Puro 100x300 cm Rect - 39"x118"
PAVIMENTO / FLOOR Ebony 20x121,5 cm - 8"x48"



PAVIMENTO / FLOOR Dust Strutturato 30x120 cm Rect_12"x48" 20mm

Cross Wood

BONE



BUFF



DUST



CINDER



EBONY



DESTINAZIONI D'USO_INTENDED USE:



DATI TECNICI_TECHNICAL DATA:

GRES A MASSA COLORATA COLOURED-BODY STONEWARE		GRES A MASSA COLORATA COLOURED-BODY STONEWARE	
+	9,5 mm	20 mm	
	DIN 51130: R10 Naturale DIN 51097: R11 Ext BCR TORTUS: C (A+B+C) Ext ANSI A326.3: $\mu > 0,40$ AS/NZS 4586: DCOF $\geq 0,42$ UNE ENV 12633: P4 Ext BS 7976-2: CLASE 3 Ext PTV 36+WET (Sl.96 - Sl.55) Ext	DIN 51130: R11 DIN 51097: C (A+B+C) BCR TORTUS: $\mu > 0,40$ ANSI A326.3: DCOF $\geq 0,42$ AS/NZS 4586: P4 UNE ENV 12633: CLASE 3 BS 7976-2: PTV 36+WET (Sl.96 - Sl.55)	ANSI A137.1: V3 V3 Buff, Cinder, Dust, Ebony

Cross Wood

GRES A MASSA COLORATA_COLOURED-BODY STONEWARE



20x121,5 cm - 8"x48"

Bone NATURALE	PG0CW00
Buff NATURALE	PG0CW10
Dust NATURALE	PG0CW40
Cinder NATURALE	PG0CW30
Ebony NATURALE	PG0CW20
Buff EXT	PG0CWS1
Dust EXT	PG0CWS4
Cinder EXT	PG0CWS3
Ebony EXT	PG0CWS2

PEZZI SPECIALI_TRIM PIECES

GRES A MASSA COLORATA_COLOURED-BODY STONEWARE

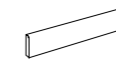

BATTISCOPA
10x60,3 cm - 4"x24"
+ 10 mm
NATURALE

BONE	PGRCW00
BUFF	PGRCW10
DUST	PGRCW40
CINDER	PGRCW30
EBONY	PGRCW20

GRES A MASSA COLORATA_COLOURED-BODY STONEWARE 20 mm



COSTA TORO ANGOLARE DX
30x60 cm Rect - 12"x24"
STRUTTURATO



COSTA TORO ANGOLARE SX
30x60 cm Rect - 12"x24"
STRUTTURATO

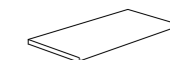

COSTA TORO
30x60 cm Rect - 12"x24"
STRUTTURATO



COSTA TORO GRIP
30x60 cm Rect - 12"x24"
STRUTTURATO

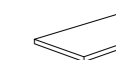

COSTA RETTA ANGOLARE DX
30x60 cm Rect - 12"x24"
STRUTTURATO

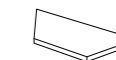

COSTA RETTA ANGOLARE SX
30x60 cm Rect - 12"x24"
STRUTTURATO

BUFF	PGDCWK1	PGDCWK6	PGDCWF1	PGDCWJ1	PGDCWD1	PGDCWD6
DUST	PGDCWK4	PGDCWK8	PGDCWF4	PGDCWJ4	PGDCWD4	PGDCWD8
CINDER	PGDCWK3	PGDCWK7	PGDCWF3	PGDCWJ3	PGDCWD3	PGDCWD7



COSTA RETTA
30x60 cm Rect - 12"x24"
STRUTTURATO



COSTA RETTA GRIP
30x60 cm Rect - 12"x24"
STRUTTURATO



GRIGLIA ANGOLARE DX
15x60 cm Rect - 6"x24"
STRUTTURATO



GRIGLIA ANGOLARE SX
15x60 cm Rect - 6"x24"
STRUTTURATO

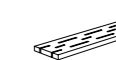

GRIGLIA
15x60 cm Rect - 6"x24"
STRUTTURATO

BUFF	PGDCWC1	PGDCWG1	PGDCWA1	PGDCWA6	PGDCWZ1
DUST	PGDCWC4	PGDCWG4	PGDCWA4	PGDCWA8	PGDCWZ4
CINDER	PGDCWC3	PGDCWG3	PGDCWA3	PGDCWA7	PGDCWZ4

- Venduti solo a scatole complete_Only full boxes sold_Nur volle Karton_Vendus par boîte complete
- Lavorati solo su richiesta_Manufactured only upon special request_Nur auf Anfrage_Seulement à la demande
- Per tutti i pz speciali consegna 30 gg_For all trim pieces 30 days delivery_Formteile haben 30 Tage lieferzeit_Livraison en 30 jours pour toutes les pièces spéciales

IMBALLAGGI E PESI_PACKINGS AND WEIGHTS

DESCRIZIONE Description	+ mm	FORMATI Sizes	SCATOLA_Box				PALLET			
			📦	KG	M ²	ML	📦	KG	M ²	
FONDO NATURALE / EXT	9,5	20x121,5	5	27,3	1,215	-	24	655	29,2	
BATTISCOPA NATURALE	10	10x60,3	16	20	0,964	9,648	48	960	46,310	
FONDO STRUTTURATO	20	30x120 ^{RECT}	2	33,25	0,72	-	32	1064	23,04	
COSTA TORO STRUTTURATO	20	30x60 ^{RECT}	1	8,125	0,180	-	100	812,5	18	
ANGOLO COSTA TORO STRUTTURATO	20	30x60 ^{RECT}	1	6,10	0,135	-	100	610	13,50	
COSTA TORO GRIP STRUTTURATO	20	30x60 ^{RECT}	1	8,125	0,180	-	100	812,5	18	
COSTA RETTA STRUTTURATO	20	30x60 ^{RECT}	1	8,125	0,180	-	100	812,5	18	
ANGOLO COSTA RETTA STRUTTURATO	20	30x60 ^{RECT}	1	6,10	0,135	-	100	610	13,50	
COSTA RETTA GRIP STRUTTURATO	20	30x60 ^{RECT}	1	8,125	0,180	-	100	812,5	18	
GRIGLIA STRUTTURATO	20	15x60 ^{RECT}	2	8	0,180	-	100	800	18	
ANGOLO GRIGLIA STRUTTURATO	20	15x60 ^{RECT}	2	7	0,157	-	100	700	15,75	



Doghe



ROVERE NATURALE



ROVERE OLIATO



ROVERE VERNICIATO

GRES PORCELLANATO LAMINATO_LAMINATED PORCELAIN STONEWARE **Zero.3**



± 3,5 mm



100x300 cm Rect
39"x118"



20x200 cm Rect
8"x79"



20x150 cm Rect
8"x59"



20x100 cm Rect
8"x39"



RIVESTIMENTO / WALL Rovere Naturale 20x150 cm Rect - 8"x59" _Rovere Naturale 20x100 cm Rect - 8"x39"
Rovere Verniciato 20x150 cm Rect - 8"x59" _Rovere Verniciato 20x100 cm Rect - 8"x39"
PAVIMENTO / FLOOR Rovere Oliato 20x200 cm Rect - 8"x79" _Rovere Oliato 20x150 cm Rect - 8"x59" _Rovere Oliato 20x100 cm Rect - 8"x39"

Doghe

ROVERE NATURALE





ROVERE OLIATO





ROVERE VERNICIATO



DESTINAZIONI D'USO_INTENDED USE: NATURALE  

DATI TECNICI_TECHNICAL DATA:

GRES PORCELLANATO LAMINATO LAMINATED PORCELAIN STONEWARE	
+	3,5 mm
	DIN 51130: R10 DIN 51097: B (A+B) BCR TORTUS: $\mu > 0,40$ ANSI A326.3: DCOF $\geq 0,42$ AS/NZS 4586: P3 BS 7976-2: PTV 36+WET (SI.96)
	ANSI A137.1: V2

Doghe

GRES PORCELLANATO LAMINATO_LAMINATED PORCELAIN STONEWARE **Zero.3**



100x300 cm Rect - 39"x118"

Rovere Naturale NATURALE PZ7DG065
Rovere Oliato NATURALE PZ7DG165
Rovere Verniciato NATURALE PZ7DG265



20x200 cm Rect - 8"x79"

Rovere Naturale NATURALE PZ3DG06
Rovere Oliato NATURALE PZ3DG16
Rovere Verniciato NATURALE PZ3DG26



20x150 cm Rect - 8"x59"







Rovere Naturale NATURALE PZ1DG06
Rovere Oliato NATURALE PZ1DG16
Rovere Verniciato NATURALE PZ1DG26



20x100 cm Rect - 8"x39"

Rovere Naturale NATURALE PZ2DG061
Rovere Oliato NATURALE PZ2DG161
Rovere Verniciato NATURALE PZ2DG261

IMBALLAGGI E PESI_PACKINGS AND WEIGHTS

DESCRIZIONE Description	+ mm	FORMATI Sizes	SCATOLA_Box				PALLET		
									
FONDO NATURALE	3,5	20x150 ^{RECT}	5	11,7	1,5	-	40	468	60
FONDO NATURALE	3,5	20x100 ^{RECT}	5	7,8	1	-	60	468	60
FONDO NATURALE	3,5	20x200 ^{RECT}	4	12,48	1,6	-	40	499,2	64
FONDO NATURALE	3,5	300x100 ^{RECT}	1	23,4	3	-	20	468	60



In-Wood

Fiordo



IN-MOOD



IN-LIFE

GRES SMALTATO_GLAZED PORCELAIN STONEWARE



± 9,5 mm



20x121,5 cm
8"x48"



RIVESTIMENTO / WALL Motion Dun Blocks 30x56,5 cm - 12"x24 1/4"
 PAVIMENTO / FLOOR In-Life 20x121,5 cm - 8"x48"



In-Wood

IN-MOOD



IN-LIFE





DESTINAZIONI D'USO_INTENDED USE: NATURALE   

DATI TECNICI_TECHNICAL DATA:

GRES SMALTATO
GLAZED PORCELAIN STONWARE

 9,5 mm

 DIN 51130: **R10** Naturale
DIN 51097: **A** Naturale
BCR TORTUS: $\mu > 0,40$
ANSI A326.3: **DCOF $\geq 0,42$**
ISO 10545-7: **PEI 5**

 ANSI A137.1: **V2**

In-Wood

GRES SMALTATO_GLAZED PORCELAIN STONWARE

 9,5 mm

20x121,5 cm - 8"x48"

In-Mood NATURALE FG0IW20

In-Life NATURALE FG0IW10

PEZZI SPECIALI_TRIM PIECES

GRES SMALTATO_GLAZED PORCELAIN STONWARE

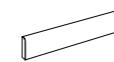

BATTISCOPA
10x60,4 cm - 4"x24"







 10 mm

NATURALE

IN-MOOD **FGRIW20**

IN-LIFE **FGRIW10**

IMBALLAGGI E PESI_PACKINGS AND WEIGHTS

DESCRIZIONE Description	+ mm	FORMATI Sizes	SCATOLA_Box				PALLET			
										
FONDO NATURALE	9,5	20x121,5	5	27,3	1,215	-	24	655	29,2	
BATTISCOPA NATURALE	10	10x60,4	16	20	0,966	9,664	48	960	46,387	



North Cape



REISA



DROVE



RONDANE



GUTULIA

GRES A MASSA COLORATA_COLOURED-BODY STONEWARE



± 12 mm
± 9,5 mm



30x180 cm Rect
12"x71"

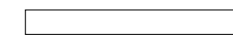

20x180 cm Rect
8"x71"



20x90,5 cm
8"x36"



PAVIMENTO / FLOOR Drove 30x180 cm Rect - 12"x71" _Drove 20x180 cm Rect - 8"x71"



PAVIMENTO / FLOOR Rondane 30x180 cm Rect - 12"x71"

North Cape

PROTECT
ANTIBATTERICO - ANTIMICROBIAL

REISA



DROVE





RONDANE





GUTULIA



DESTINAZIONI D'USO_INTENDED USE: NATURALE   

DATI TECNICI_TECHNICAL DATA:

	GRES A MASSA COLORATA COLOURED-BODY STONEWARE	GRES A MASSA COLORATA COLOURED-BODY STONEWARE
±	9,5 mm	12 mm
	DIN 51130: R9 BCR TORTUS: $\mu > 0,40$ ANSI A326.3: DCOF $\geq 0,42$	DIN 51130: R9 BCR TORTUS: $\mu > 0,40$ ANSI A326.3: DCOF $\geq 0,42$
	ANSI A137.1: V2 Rondane V3 Gutulia, Drove, Reisa	ANSI A137.1: V2 Rondane V3 Gutulia, Drove, Reisa

PROTECT
ANTIBATTERICO - ANTIMICROBIAL

North Cape

GRES A MASSA COLORATA_COLOURED-BODY STONEWARE



30x180 cm Rect - 12"x71"

Reisa NATURALE	PGICN201
Drove NATURALE	PGICN001
Rondane NATURALE	PGICN301
Gutulia NATURALE	PGICN101



20x180 cm Rect - 8"x71"

Reisa NATURALE	PG4CN201
Drove NATURALE	PG4CN001
Rondane NATURALE	PG4CN301
Gutulia NATURALE	PG4CN101



20x90,5 cm - 8"x36"

Reisa NATURALE*	PG2NC20
Drove NATURALE*	PG2NC00
Rondane NATURALE*	PG2NC30
Gutulia NATURALE*	PG2NC10

PEZZI SPECIALI_TRIM PIECES



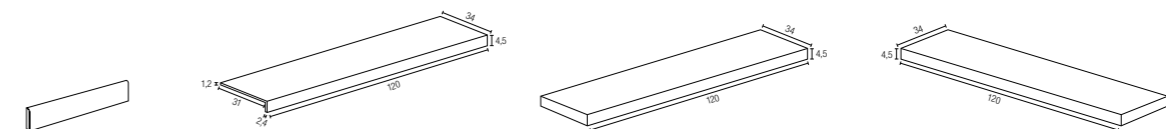



GRES A MASSA COLORATA_COLOURED-BODY STONEWARE



	BATTISCOPIA 10x60,3 cm - 4"x24" ± 10 mm NATURALE	GRADINO BORDO PLUS 34x120x4,5 cm Rect - 13 ^{3/8} "x48x1 ^{3/4} " ± 12 mm NATURALE	GRADINO ANGOLARE PLUS DX 34x120x4,5 cm Rect - 13 ^{3/8} "x48x1 ^{3/4} " ± 12 mm NATURALE	GRADINO ANGOLARE PLUS SX 34x120x4,5 cm Rect - 13 ^{3/8} "x48x1 ^{3/4} " ± 12 mm NATURALE
REISA	PGRNC20	PGDNC20	PGDNC21	PGDNC22
DROVE	PGRNC00	PGDNC00	PGDNC01	PGDNC02
RONDANE	PGRNC30	PGDNC30	PGDNC31	PGDNC32
GUTULIA	PGRNC10	PGDNC10	PGDNC11	PGDNC12

Trattandosi di pezzi artigianali possono verificarsi piccole variazioni dimensionali_Handmade pieces: light size variations may occur_Da es sich um handgemachte Teile handelt, können es kleine dimensionale Veränderungen auftreten_Étant donné qu'il s'agit de pièces faites à la main il peut y avoir des petits changements dimensionnels

IMBALLAGGI E PESI_PACKINGS AND WEIGHTS

DESCRIZIONE Description	± mm	FORMATI Sizes	SCATOLA_Box				PALLET		
									
FONDO NATURALE	12	30x180 RECT	2	30,20	1,08	-	45	1359	48,60
FONDO NATURALE	12	20x180 RECT	3	30	1,08	-	48	1440	51,84
FONDO NATURALE	9,5	20x90,5	6	23,3	1,086	-	48	1117	52,1
BATTISCOPIA NATURALE	10	10x60,3	16	20	0,964	9,648	48	960	46,31
GRADINO BORDO PLUS NATURALE	12	120x34x4,5 RECT	2	35	0,816	-	12	420	9,792
GRADINO ANGOLARE PLUS NATURALE	12	120x34x4,5 RECT	1	17,50	0,408	-	24	420	9,792

* Protezione antibatterica non presente_No antimicrobial protectio_Der Antibakterielle Schutz nicht vorhanden_Protection antibactérienne pas présente



Nuance



CARAMEL



MIEL



TABAC



CENDRE



PERLE

GRES A MASSA COLORATA_COLOURED-BODY STONEWARE



± 12 mm
± 9,5 mm

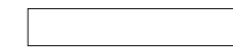

30x180 cm
12"x71"



20x180 cm
8"x71"



30x120 cm
12"x48"



20x120 cm
8"x48"

GRES A MASSA COLORATA_COLOURED-BODY STONEWARE 20 mm



± 20 mm

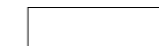

40x120 cm
16"x48"



RIVESTIMENTO / WALL Chevron Miel 55x38 cm Rect - 21 5/8" x 15"
PAVIMENTO / FLOOR Miel 20x120 cm Rect - 8" x 48"



RIVESTIMENTO / WALL Décoratif Perle 60x60 cm Rect - 24" x 24"
PAVIMENTO / FLOOR Cendre 30x120 cm Rect - 12" x 48"



RIVESTIMENTO / WALL Eternity 0.3 Breach Grey Lux 120x260 cm Rect - 48"x102"
PAVIMENTO / FLOOR Caramel 30x180 cm Rect - 12"x71"_Caramel 20x180 cm Rect - 8"x71"



PAVIMENTO / FLOOR Listello Tabac 7x60 cm Rect - 2³/₄"x24" _Quadrato Tabac 7x7 cm Rect - 2³/₄"x2³/₄"
Trilogy Calacatta White Lux 60x60 cm Rect - 24"x24"



PAVIMENTO / FLOOR Chevron Cendre 55x38 cm Rect_21⁵/₈"x15"



PAVIMENTO / FLOOR Tabac 20x120 cm Rect - 8"x48" _Tabac Strutturato 20x120 cm Rect - 8"x48"

Nuance

PROTECT
ANTIBATTERICO - ANTIMICROBIAL

CARAMEL



MIEL



TABAC



CENDRE



PERLE



DESTINAZIONI D'USO_INTENDED USE: NATURALE STRUTTURATO

DATI TECNICI_TECHNICAL DATA:

GRES A MASSA COLORATA COLOURED-BODY STONEWARE		GRES A MASSA COLORATA COLOURED-BODY STONEWARE	
±	12 / 9,5 mm	±	20 mm
DIN 51130:	R10 Naturale R11 Strutturato	DIN 51130:	R11
DIN 51097:	C (A+B+C) Strutturato	DIN 51097:	C (A+B+C)
BCR TORTUS:	μ > 0,40	BCR TORTUS:	μ > 0,40
ANSI A326.3:	DCOF ≥ 0,42	ANSI A326.3:	DCOF ≥ 0,42
AS/NZS 4586:	P4 Strutturato	AS/NZS 4586:	P4
BS 7976-2:	PTV 36+WET (SI.96 - SI.55) Strutturato	UNE ENV 12633:	CLASE 3
		BS 7976-2:	PTV 36+WET (SI.96 - SI.55)
	ANSI A137.1: V3		ANSI A137.1: V3
PROTECT ANTIBATTERICO - ANTIMICROBIAL			

Nuance

GRES A MASSA COLORATA_COLOURED-BODY STONEWARE



30x180 cm Rect - 12"x71"

Caramel NATURALE	PG1N100
Miel NATURALE	PG1N120
Tabac NATURALE	PG1N140
Cendre NATURALE	PG1N110
Perle NATURALE	PG1N130



20x180 cm Rect - 8"x71"

Caramel NATURALE	PG4N100
Miel NATURALE	PG4N120
Tabac NATURALE	PG4N140
Cendre NATURALE	PG4N110
Perle NATURALE	PG4N130



30x120 cm Rect - 12"x48"

Caramel NATURALE	PG6N100
Miel NATURALE	PG6N120
Tabac NATURALE	PG6N140
Cendre NATURALE	PG6N110
Perle NATURALE	PG6N130



20x120 cm Rect - 8"x48"

Caramel NATURALE	PGON100
Miel NATURALE	PGON120
Tabac NATURALE	PGON140
Cendre NATURALE	PGON110
Perle NATURALE	PGON130
Caramel STRUTTURATO*	PGON105
Miel STRUTTURATO*	PGON125
Tabac STRUTTURATO*	PGON145
Cendre STRUTTURATO*	PGON115
Perle STRUTTURATO*	PGON135

GRES A MASSA COLORATA_COLOURED-BODY STONEWARE 20 mm



40x120 cm Rect - 16"x48"

Caramel STRUTTURATO*	PG9N100
Miel STRUTTURATO*	PG9N120
Tabac STRUTTURATO*	PG9N140

DECORI_DECORS

GRES A MASSA COLORATA_COLOURED-BODY STONEWARE

CARAMEL



DÉCORATIF NATURALE
60x60 cm Rect - 24"x24"
± 9,5 mm

PGWN100

MIEL



DÉCORATIF NATURALE
60x60 cm Rect - 24"x24"
± 9,5 mm

PGWN120

TABAC



DÉCORATIF NATURALE
60x60 cm Rect - 24"x24"
± 9,5 mm

PGWN140

CENDRE



DÉCORATIF NATURALE
60x60 cm Rect - 24"x24"
± 9,5 mm

PGWN110

PERLE



DÉCORATIF NATURALE
60x60 cm Rect - 24"x24"
± 9,5 mm

PGWN130



CHEVRON NATURALE
55x38 cm Rect - 21^{5/8}"x15"
± 9,5 mm

PGZN110



CHEVRON NATURALE
55x38 cm Rect - 21^{5/8}"x15"
± 9,5 mm

PGZN112



CHEVRON NATURALE
55x38 cm Rect - 21^{5/8}"x15"
± 9,5 mm

PGZN114



CHEVRON NATURALE
55x38 cm Rect - 21^{5/8}"x15"
± 9,5 mm

PGZN111



CHEVRON NATURALE
55x38 cm Rect - 21^{5/8}"x15"
± 9,5 mm

PGZN113

* Protezione antibatterica non presente_No antimicrobial protectio_Der Antibakterielle Schutz nicht vorhanden_Protection antibactérienne pas présente

CHEVRON:

Questi formati speciali vengono realizzati con un sistema di taglio a disco senza bisello. L'eventuale presenza di leggere irregolarità del bordo e di scostamenti dimensionali fino ad 1 mm sono da ritenersi conformi. Possibilità di utilizzo a pavimento in interni_These special formats are produced with a disc cutting system without a bevel. Any slight irregularities of the edge and size deviations of up to 1 mm should be regarded as compliant. Suitable for interiors floor_Diese Sonderformate werden mit einem Scheibenschnittsystem ohne Fase hergestellt. Eventuelle leichte Unregelmäßigkeiten an der Kante und Größenabweichungen bis zu 1 mm sind als konform anzusehen. Möglichkeit der Verwendung als Boden in Innenbereichen_Ces formats spéciaux sont réalisés avec une système de découpe à disque sans biseau. L'éventuelle présence de légères irrégularités du bord et de différences de dimension jusqu'à 1 mm est tout à fait conforme. Possibilité d'utilisation pour les sols à l'intérieur.

Nuance

DECORI_DECORS

GRES A MASSA COLORATA_COLOURED-BODY STONEWARE

CARAMEL



MOSAIQUE NATURALE
30x30 cm Rect - 12"x12"
± 9,5 mm
PGZN120

MIEL



MOSAIQUE NATURALE
30x30 cm Rect - 12"x12"
± 9,5 mm
PGZN122

TABAC



MOSAIQUE NATURALE
30x30 cm Rect - 12"x12"
± 9,5 mm
PGZN124

CENDRE



MOSAIQUE NATURALE
30x30 cm Rect - 12"x12"
± 9,5 mm
PGZN121

PERLE



MOSAIQUE NATURALE
30x30 cm Rect - 12"x12"
± 9,5 mm
PGZN123



LISTELLO NATURALE
7x60 cm Rect - 2^{3/4}"x24"
± 9,5 mm
PGZN1L0



LISTELLO NATURALE
7x60 cm Rect - 2^{3/4}"x24"
± 9,5 mm
PGZN1L2



LISTELLO NATURALE
7x60 cm Rect - 2^{3/4}"x24"
± 9,5 mm
PGZN1L4



LISTELLO NATURALE
7x60 cm Rect - 2^{3/4}"x24"
± 9,5 mm
PGZN1L1



LISTELLO NATURALE
7x60 cm Rect - 2^{3/4}"x24"
± 9,5 mm
PGZN1L3



QUADRATO NATURALE
7x7 cm Rect - 2^{3/4}"x2^{3/4}"
± 9,5 mm
PGZN100



QUADRATO NATURALE
7x7 cm Rect - 2^{3/4}"x2^{3/4}"
± 9,5 mm
PGZN102



QUADRATO NATURALE
7x7 cm Rect - 2^{3/4}"x2^{3/4}"
± 9,5 mm
PGZN104



QUADRATO NATURALE
7x7 cm Rect - 2^{3/4}"x2^{3/4}"
± 9,5 mm
PGZN101



QUADRATO NATURALE
7x7 cm Rect - 2^{3/4}"x2^{3/4}"
± 9,5 mm
PGZN103

ESEMPI COMPOSIZIONI_TILE LAYOUT EXAMPLES



NUANCE LISTELLO Tabac
NUANCE QUADRATO Tabac
TRILOGY Calacatta White Lux 60x60 cm Rect



NUANCE LISTELLO Perle
NUANCE QUADRATO Cendre
TRILOGY Calacatta White Lux 60x60 cm Rect



NUANCE LISTELLO Cendre
NUANCE QUADRATO Perle
TRILOGY Calacatta White Lux 60x60 cm Rect

Per questo tipo di posa Listello e Quadrato Nuance sono abbinabili tra loro e con tutti i fondi 60x60 rettificati delle collezioni a catalogo. For this laying solution Nuance Listello and Quadrato are matchable with the 60x60 rectified of all collections. Bei dieser Art von Verlegung sind Listello und Quadrato Nuance untereinander und mit allen begnadigten 60x60 Untergründen der Katalogkolektionen kombinierbar. Pour ce type de pose Listello et Quadrato Nuance sont combinables entre eux et avec tous les fonds de 60x60 rectifiés des collections du catalogue.

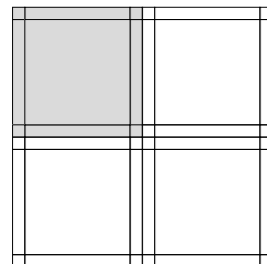

Modulo A_Modulo A_Modul A_Modulo A
4 PEZZI 7x60 (30,68%)
4 PEZZI 7x7 (3,58%)
1 PEZZO 60x60 (80,20%)

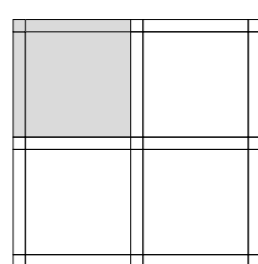

Modulo B_Modulo B_Modul B_Modulo B
2 PEZZI 7x60 (18,71%)
1 PEZZI 7x7 (1,09%)
1 PEZZO 60x60 (80,20%)

MOSAIQUE, LISTELLO, QUADRATO:

Possibilità di utilizzo a pavimento in interni_Suitable for interiors floor_Möglichkeit der Verwendung als Boden in Innenbereichen_Possibilité d'utilisation pour les sols à l'intérieur.

Nuance

PEZZI SPECIALI_TRIM PIECES

GRES A MASSA COLORATA_COLOURED-BODY STONEWARE

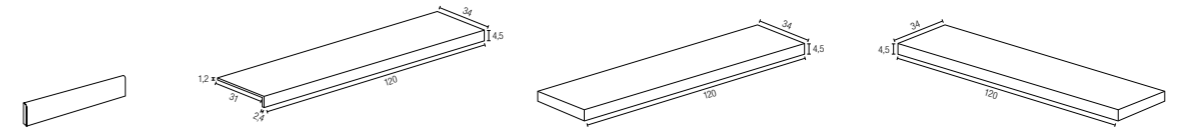

BATTISCOPA
10x60 cm - 4"x24"
± 10 mm
NATURALE

GRADINO BORDO PLUS
34x120x4,5 cm Rect - 13^{3/8}"x48x1^{3/4}"
± 9,5 mm
NATURALE

GRADINO ANGOLARE PLUS DX
34x120x4,5 cm Rect - 13^{3/8}"x48x1^{3/4}"
± 9,5 mm
NATURALE

GRADINO ANGOLARE PLUS SX
34x120x4,5 cm Rect - 13^{3/8}"x48x1^{3/4}"
± 9,5 mm
NATURALE

CARAMEL	PGRN100	PGDN100	PGDN101	PGDN102
MIEL	PGRN120	PGDN120	PGDN121	PGDN122
TABAC	PGRN140	PGDN140	PGDN141	PGDN142
CENDRE	PGRN110	PGDN110	PGDN111	PGDN112
PERLE	PGRN130	PGDN130	PGDN131	PGDN132

GRES A MASSA COLORATA_COLOURED-BODY STONEWARE 20 mm

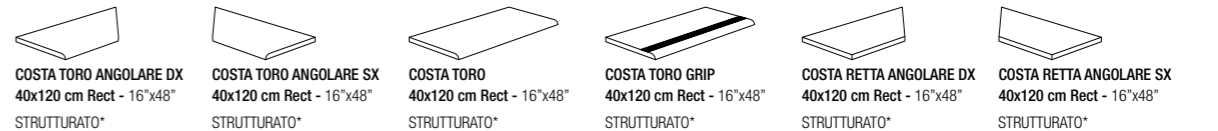

COSTA TORO ANGOLARE DX
40x120 cm Rect - 16"x48"
STRUTTURATO*

COSTA TORO ANGOLARE SX
40x120 cm Rect - 16"x48"
STRUTTURATO*

COSTA TORO
40x120 cm Rect - 16"x48"
STRUTTURATO*

COSTA TORO GRIP
40x120 cm Rect - 16"x48"
STRUTTURATO*

COSTA RETTA ANGOLARE DX
40x120 cm Rect - 16"x48"
STRUTTURATO*

COSTA RETTA ANGOLARE SX
40x120 cm Rect - 16"x48"
STRUTTURATO*

CARAMEL	PGDN1K3	PGDN1K0	PGDN1F0	PGDN1J0	PGDN1D3	PGDN1D0
MIEL	PGDN1K4	PGDN1K1	PGDN1F2	PGDN1J2	PGDN1D4	PGDN1D1
TABAC	PGDN1K5	PGDN1K2	PGDN1F4	PGDN1J4	PGDN1D5	PGDN1D2



COSTA RETTA
40x120 cm Rect - 16"x48"
STRUTTURATO*



COSTA RETTA GRIP
40x120 cm Rect - 16"x48"
STRUTTURATO*



GRIGLIA ANGOLARE DX
15x60 cm Rect - 6"x24"
STRUTTURATO*



GRIGLIA ANGOLARE SX
15x60 cm Rect - 6"x24"
STRUTTURATO*



GRIGLIA
15x60 cm Rect - 6"x24"
STRUTTURATO*

* Protezione antibatterica non presente_No antimicrobial protectio_Der Antibakterielle Schutz nicht vorhanden_Protection antibactérienne pas présente

IMBALLAGGI E PESI_PACKINGS AND WEIGHTS

DESCRIZIONE Description	± mm	FORMATI Sizes	SCATOLA_Box				PALLET			
			📦	📊	📏	📏	📦	📊	📏	📏
FONDO NATURALE	9,5	20x120 RECT	5	27,2	1,2	-	24	653	28,8	
FONDO STRUTTURATO	9,5	20x120 RECT	5	27,2	1,2	-	24	653	28,8	
FONDO NATURALE	9,5	30x120 RECT	4	30,4	1,44	-	18	547	25,9	
FONDO NATURALE	12	20x180 RECT	3	30	1,08	-	48	1440	51,84	
FONDO NATURALE	12	30x180 RECT	2	30,2	1,08	-	45	1359	48,60	
DÉCORATIF	9,5	60x60 RECT	2	15,9	0,72	-	30	477	21,60	
CHEVRON	9,5	55x38 RECT	4	17,1	0,836	-	24	410	20,1	
MOSAIQUE	9,5	30x30 RECT	6	11,1	0,54	-	42	467	22,7	
LISTELLO	9,5	7x60 RECT	16	13,8	0,672	-	40	551	26,9	
QUADRATO	9,5	7x7 RECT	16	1,6	0,078	-	456	736	35,8	
GRADINO BORDO PLUS NATURALE	9,5	34x120x4,5 RECT	2	33,3	0,816	-	12	399	9,8	
GRADINO ANGOLARE PLUS NATURALE	9,5	34x120x4,5 RECT	1	16,6	0,408	-	24	399	9,8	
BATTISCOPA NATURALE	10	10x60 RECT	12	15,48	0,72	7,20	60	928,8	43,2	
FONDO STRUTTURATO	20	40x120 RECT	1	23	0,48	-	32	736	15,36	
COSTA TORO STRUTTURATO	20	40x120 RECT	1	23	0,48	-	-	-	-	
ANGOLO COSTA TORO STRUTTURATO	20	40x120 RECT	1	21	0,4	-	-	-	-	
COSTA TORO GRIP STRUTTURATO	20	40x120 RECT	1	23	0,48	-	-	-	-	
COSTA RETTA STRUTTURATO	20	40x120 RECT	1	23	0,48	-	-	-	-	
ANGOLO COSTA RETTA STRUTTURATO	20	40x120 RECT	1	21	0,4	-	-	-	-	
COSTA RETTA GRIP STRUTTURATO	20	40x120 RECT	1	23	0,48	-	-	-	-	
GRIGLIA STRUTTURATO	20	15x60 RECT	2	8	0,18	-	100	800	18	
ANGOLO GRIGLIA STRUTTURATO	20	15x60 RECT	2	4	0,1575	-	100	700	15,75	



Wood Relive

Fiordo



FLORIDA

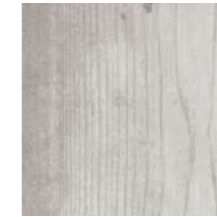

ALASKA



OREGON



MONTANA

GRES SMALTATO_GLAZED PORCELAIN STONEWARE



± 9,5 mm

20x121,5 cm
8"x48"



PAVIMENTO / FLOOR Alaska 20x121,5 cm - 8"x48"



PAVIMENTO / FLOOR Oregon 20x121,5 cm - 8"x48"



RIVESTIMENTO / WALL Florida 20x121,5 cm - 8"x48"



PAVIMENTO / FLOOR Florida 20x121,5 cm - 8"x48"

Wood Relive

FLORIDA



ALASKA





OREGON



MONTANA





DESTINAZIONI D'USO_INTENDED USE: NATURALE   

DATI TECNICI_TECHNICAL DATA:

GRES SMALTATO
GLAZED PORCELAIN STONEWARE

 9,5 mm

 DIN 51130: **R10**
DIN 51097: **B (A+B)**
BCR TORTUS: $\mu > 0,40$
ANSI A326.3: **DCOF $\geq 0,42$**

 ANSI A137.1: **V2** Florida
V3 Alaska, Oregon, Montana

Wood Relive

GRES SMALTATO_GLAZED PORCELAIN STONEWARE

 9,5 mm

20x121,5 cm - 8"x48"

Florida NATURALE FGOWR10
Alaska NATURALE FGOWR00
Oregon NATURALE FGOWR30
Montana NATURALE FGOWR20

PEZZI SPECIALI_TRIM PIECES



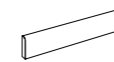





GRES SMALTATO_GLAZED PORCELAIN STONEWARE



BATTISCOPIA
10x60,4 cm - 4"x24"
 10 mm
NATURALE

FLORIDA **FGRWR10**
ALASKA **FGRWR00**
OREGON **FGRWR30**
MONTANA **FGRWR20**

IMBALLAGGI E PESI_PACKINGS AND WEIGHTS

DESCRIZIONE Description	 mm	FORMATI Sizes	SCATOLA_Box				PALLET			
				 KG	 M ²	 ML		 KG	 M ²	
FONDO NATURALE	9,5	20x121,5	5	27,3	1,215	-	24	655	29,2	
BATTISCOPIA NATURALE	10	10x60,4	16	20	0,966	9,664	48	960	46,387	



Effetto cromatico



Chromatic look



Even

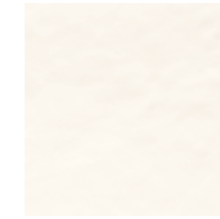

SNOW



IVORY



DOVE



CHERRY



LEAF



OCEAN

RIVESTIMENTO MONOPOROSA_SINGLE-FIRED WALL TILES

± 10,5 mm



35x100 cm Rect
13^{3/4}"x39"



RIVESTIMENTO / WALL Ocean 35x100 cm Rect - 13^{3/4}"x39" Framework 35x100 cm Rect - 13^{3/4}"x39"
PAVIMENTO / FLOOR Nuance Caramel 20x120 cm - 8"x48" 30x120 cm - 12"x48"



RIVESTIMENTO / WALL Cherry 35x100 cm Rect - 13^{3/4}"x39" _Geometric Warm 35x35 cm Rect - 13^{3/4}"x13^{3/4}" _Shapes Snow 35x100 cm Rect - 13^{3/4}"x39"
PAVIMENTO / FLOOR Context Loft 60x60 cm Rect - 24"x24"



PAVIMENTO / FLOOR Optical 35x100 cm Rect - 13^{3/4}"x39"

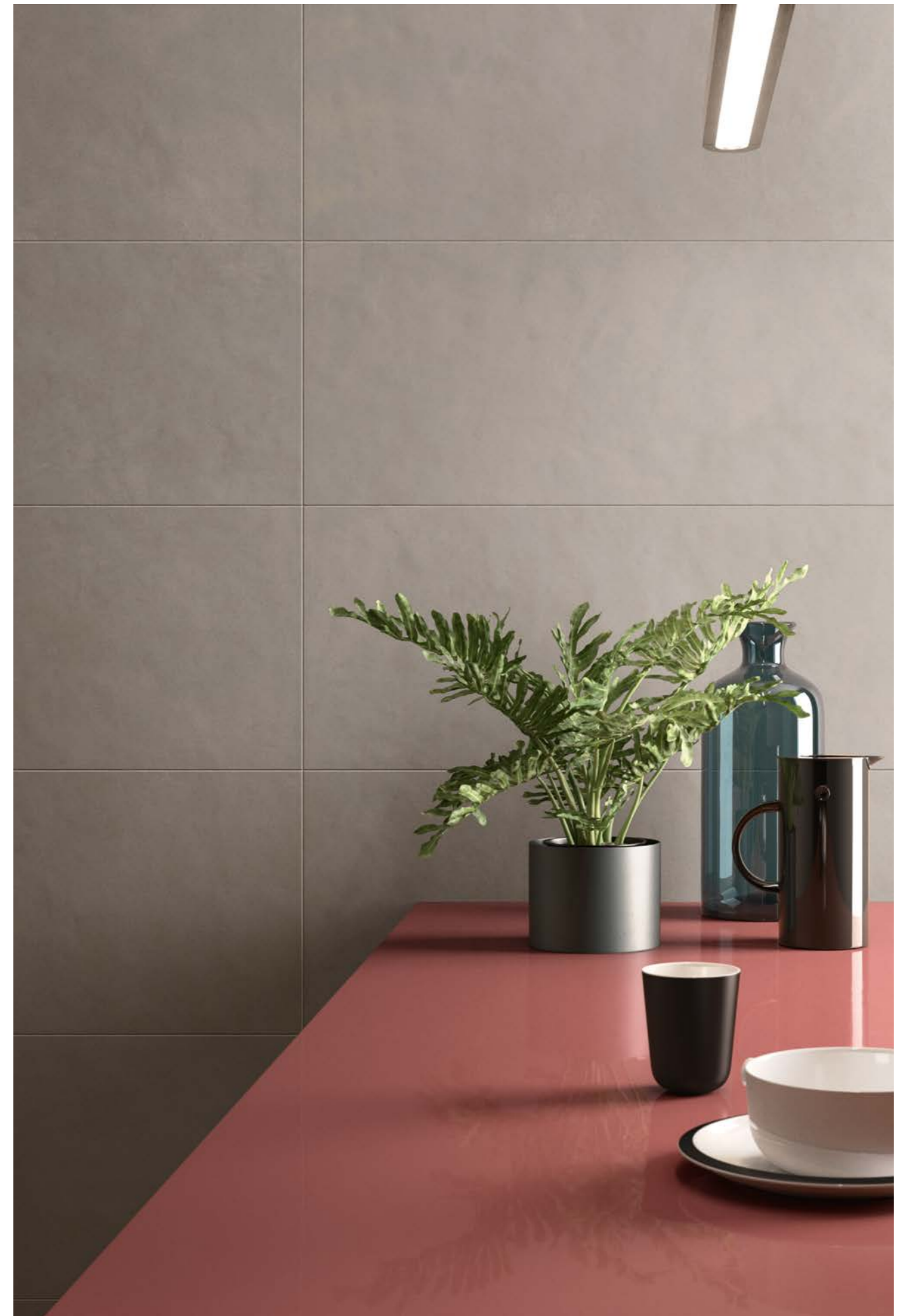

RIVESTIMENTO / WALL Dove 35x100 cm Rect - 13^{3/4}"x39"



RIVESTIMENTO / WALL Shapes Snow 35x100 cm Rect - 13^{3/4}"x39" _Medley Cold 35x100 cm Rect - 13^{3/4}"x39"



RIVESTIMENTO / WALL Leaf 35x100 cm Rect - 13^{3/4}"x39" _Shapes Ivory 35x100 cm Rect - 13^{3/4}"x39"



RIVESTIMENTO / WALL Ocean 35x100 cm Rect - 13^{3/4}"x39" _Shapes Ocean 35x100 cm Rect - 13^{3/4}"x39"
PAVIMENTO / FLOOR Context Hangar 120x120 cm Rect - 48"x48"

Even

SNOW

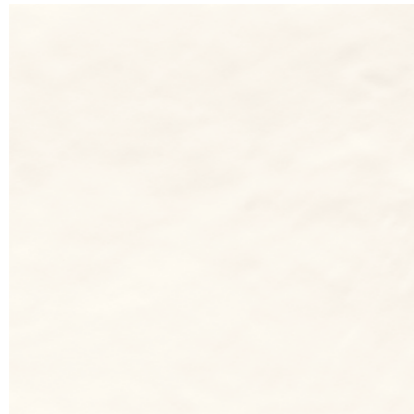

IVORY



DOVE



CHERRY



LEAF



OCEAN

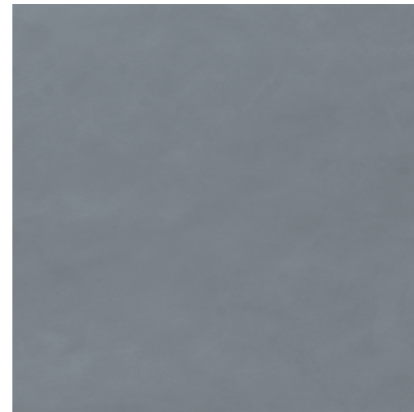

DATI TECNICI / TECHNICAL DATA:

RIVESTIMENTO MONOPOROSA SINGLE-FIRED WALL TILES	
	10,5 mm
	ANSI A137.1: V1

Even

RIVESTIMENTO MONOPOROSA_SINGLE-FIRED WALL TILES

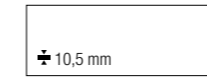

35x100 cm Rect - 13^{3/4}"x39"

- Snow PBF50
- Ivory PBF20
- Dove PBF10
- Cherry PBF00
- Leaf PBF30
- Ocean PBF40

DECORI_DECORS

RIVESTIMENTO MONOPOROSA_SINGLE-FIRED WALL TILES



FRAMEWORK
35x100 cm Rect - 13^{3/4}"x39"
✚ 10,5 mm
PBF50



OPTICAL
35x100 cm Rect - 13^{3/4}"x39"
✚ 10,5 mm
PBF50



MEDLEY COLD
35x100 cm Rect - 13^{3/4}"x39"
✚ 10,5 mm
PBF50



MEDLEY WARM
35x100 cm Rect - 13^{3/4}"x39"
✚ 10,5 mm
PBF50



MEDLEY MIX
35x100 cm Rect - 13^{3/4}"x39"
✚ 10,5 mm
PBF50

MEDLEY:

Sviluppati su 6 soggetti_Developed on 6 patterns_Entwickelt auf 6 Bilder_Développe sur 6 éléments
I soggetti all'interno della scatola sono presenti in modo casuale_The six patterns are placed in the box randomly_Die Dekor-Bilder sind zufällig eingepack_Les sujets à l'intérieurs de la boîte son présent de façon casuelle

FRAMEWORK:

Sviluppato su 4 soggetti_Developed on 4 patterns_Entwickelt auf 4 Bilder_Développe sur 4 éléments

Even

DECORI_DECORS

RIVESTIMENTO MONOPOROSA_SINGLE-FIRED WALL TILES

SNOW



SHAPES
35x100 cm Rect - 13^{3/4}"x39"
± 10,5 mm
PBFEVS5

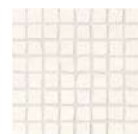

MOSAICO
20x20 cm Rect - 8"x8"
± 10,5 mm
PBEEV50

IVORY



SHAPES
35x100 cm Rect - 13^{3/4}"x39"
± 10,5 mm
PBFEVS2



MOSAICO
20x20 cm Rect - 8"x8"
± 10,5 mm
PBEEV20

DOVE



SHAPES
35x100 cm Rect - 13^{3/4}"x39"
± 10,5 mm
PBFEVS1

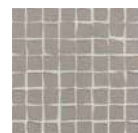

MOSAICO
20x20 cm Rect - 8"x8"
± 10,5 mm
PBEEV10

CHERRY



SHAPES
35x100 cm Rect - 13^{3/4}"x39"
± 10,5 mm
PBFEVS0



MOSAICO
20x20 cm Rect - 8"x8"
± 10,5 mm
PBEEV00

Even

LEAF



SHAPES
35x100 cm Rect - 13^{3/4}"x39"
± 10,5 mm
PBFEVS3



MOSAICO
20x20 cm Rect - 8"x8"
± 10,5 mm
PBEEV30

OCEAN



SHAPES
35x100 cm Rect - 13^{3/4}"x39"
± 10,5 mm
PBFEVS4



MOSAICO
20x20 cm Rect - 8"x8"
± 10,5 mm
PBEEV40



GEOMETRIC WARM
35x35 cm Rect - 13^{3/4}"x13^{3/4}"
± 10,5 mm
PBCEVG1



GEOMETRIC COLD
35x35 cm Rect - 13^{3/4}"x13^{3/4}"
± 10,5 mm
PBCEVG0

IMBALLAGGI E PESI_PACKINGS AND WEIGHTS

DESCRIZIONE Description	± mm	FORMATI Sizes	SCATOLA_Box				PALLET		
FONDO	10,5	35x100 ^{RECT}	3	20,15	1,05	-	28	564,2	29,4
SHAPES	10,5	35x100 ^{RECT}	3	20,15	1,05	-	26	523,9	27,3
MEDLEY COLD	10,5	35x100 ^{RECT}	3	20,15	1,05	-	28	564,2	29,4
MEDLEY WARM	10,5	35x100 ^{RECT}	3	20,15	1,05	-	28	564,2	29,4
MEDLEY MIX	10,5	35x100 ^{RECT}	3	20,15	1,05	-	28	564,2	29,4
FRAMEWORK	10,5	35x100 ^{RECT}	3	20,15	1,05	-	28	564,2	29,4
OPTICAL	10,5	35x100 ^{RECT}	3	19,8	1,05	-	12	237,6	12,6
GEOMETRIC COLD	10,5	35x35 ^{RECT}	4	12,4	0,49	-	60	744	29,4
GEOMETRIC WARM	10,5	35x35 ^{RECT}	4	12,4	0,49	-	60	744	29,4
MOSAICO	10,5	20x20 ^{RECT}	9	4,837	0,36	-	90	435,37	32,4



Must

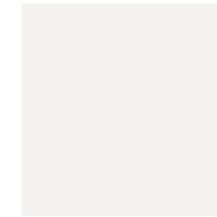

BE WHITE



BE BLACK

GRES PORCELLANATO LAMINATO / LAMINATED PORCELAIN STONEWARE **Zero.3**



± 5,5 mm



100x300 cm Rect
39"x118"



100x100 cm Rect
39"x39"



RIVESTIMENTO / WALL Be White Soft 100x300 cm Rect - 39"x118"
PAVIMENTO / FLOOR Be White Lux 100x100 cm Rect - 39"x39"



PAVIMENTO / FLOOR Be White Lux 100x100 cm Rect - 39"x39"

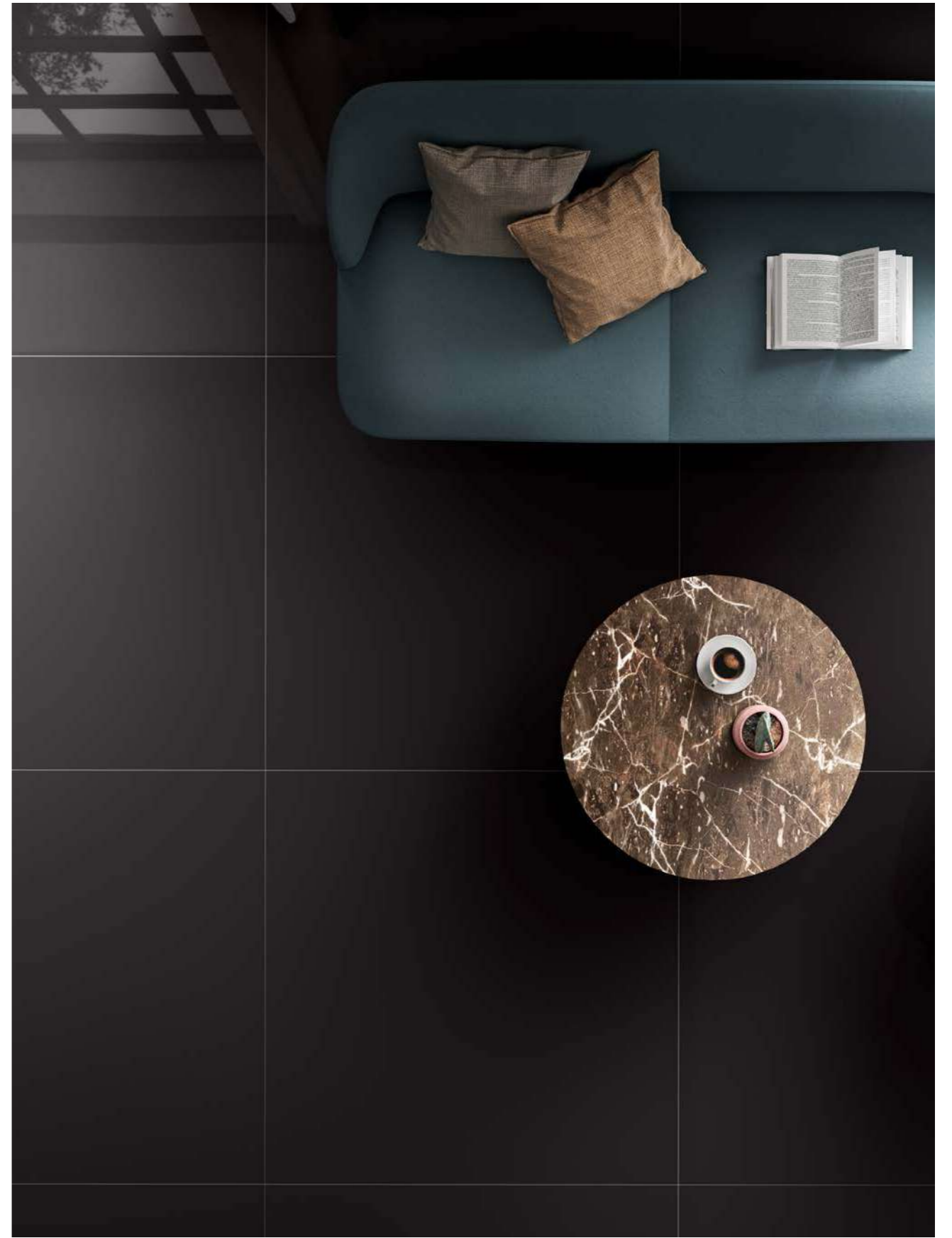

PAVIMENTO / FLOOR Be Black Lux 100x100 cm Rect - 39"x39"



RIVESTIMENTO / WALL Be Black Soft 100x300 cm Rect - 39"x118"
PAVIMENTO / FLOOR Be Black Lux 100x100 cm Rect - 39"x39"

Must

PROTECT
ANTIBATTERICO - ANTIMICROBIAL

BE WHITE

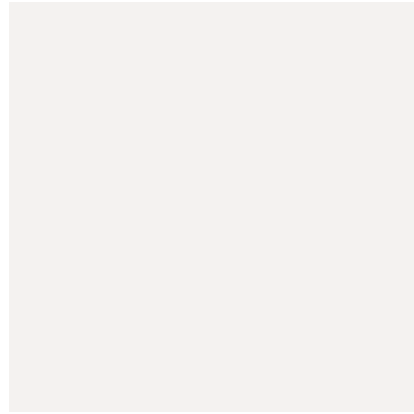

BE BLACK



Must

GRES PORCELLANATO LAMINATO / LAMINATED PORCELAIN STONEWARE **Zero.3**

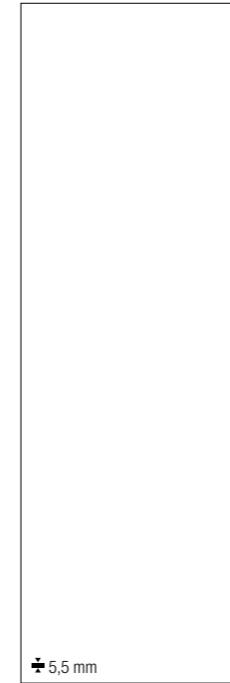

100x300 cm Rect - 39"x118"
Be White SOFT PZ7MT10
Be Black SOFT PZ7MT00
Be White LUX PZ7MTX1
Be Black LUX PZ7MTX0

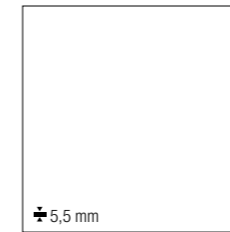

100x100 cm Rect - 39"x39"
Be White SOFT PZ8MT10
Be Black SOFT PZ8MT00
Be White LUX PZ8MTX1
Be Black LUX PZ8MTX0

DESTINAZIONI D'USO / INTENDED USE: SOFT LUX *solo Be White_only Be White

DATI TECNICI / TECHNICAL DATA:

GRES PORCELLANATO LAMINATO LAMINATED PORCELAIN STONEWARE	
5,5 mm	
ANSI A326.3: DCOF ≥ 0.42 Soft	
ANSI A137.3: V1	
PROTECT ANTIBATTERICO - ANTIMICROBIAL	

IMBALLAGGI E PESI / PACKINGS AND WEIGHTS

DESCRIZIONE Description	mm	FORMATI Sizes	SCATOLA / Box				PALLET			
				KG	M ²	ML		KG	M ²	
FONDO SOFT / LUX	5,5	100x300 RECT	1	34,50	3,00	-	13	448,5	39	
FONDO SOFT / LUX	5,5	100x100 RECT	2	23	2,00	-	25	575	50	

Dati tecnici



Technical data

Caratteristiche tecniche <i>Technical features</i>	370
Caratteristiche di sicurezza e termiche <i>Safety and thermal features</i>	378
Informazioni per la posa <i>Laying information</i>	380
Resistenza allo scivolamento <i>Slip resistance</i>	383
Tabelle calibri <i>Size table</i>	384
Pulizia <i>Cleaning</i>	386
Panaria e l'ambiente <i>Panaria and the environment</i>	393
Certificazioni di qualità <i>Quality certifications</i>	405
Indice alfabetico dei prodotti <i>List of products in alphabetical order</i>	408
Condizioni generali di vendita <i>General conditions of sale</i>	412

Caratteristiche tecniche

Technical features_Technische Eigenschaften_Caractéristiques techniques

Zero.3 GRES PORCELLANATO LAMINATO_LAMINATED PORCELAIN STONEWARE_LAMINIERTES FEINSTEINZEUG_GRÈS LAMINÉ

Conforme_according to_Gemäß_conforme: ISO 13006-G ED EN 14411-G Gruppo/Group BIA- UGL

CARATTERISTICHE TECNICHE TECHNICAL FEATURES TECHNISCHE EIGENSCHAFTEN CARACTÉRISTIQUES TECHNIQUES	METODO DI PROVA TEST METHOD PRÜFMETHODE MÉTHODE D'ESSAI	REQUISITI PRESCRITTI REQUIRED VALUE VORGESCHRIEBENER WERT VALEUR REQUISE ISO 13006-G ed EN 14411-G Gruppo BIA-UGL	VALORI MEDI AVERAGE VALUES DURCHSCHNITTLICHE WERTE VALEURS MOYENNES ZERO.3, 3PLUS*, 5PLUS*, 6mm
ASSORBIMENTO D'ACQUA WATER ABSORPTION WASSERABSORPTION ABSORPTION D'EAU	ISO 10545-3	≤ 0,5%	0,1% (1)
RESISTENZA ALLA FLESSIONE MODULUS OF RUPTURE BIEGEFESTIGKEIT RÉSISTANCE À LA FLEXION	ISO 10545-4	≥ 35 N/mm ²	50 N/mm²
RESISTENZA ALL'ABRASIONE PROFONDA DEEP ABRASION RESISTANCE WIDERSTAND GEGEN TIEFENABRIEB RÉSISTANCE À L'ABRASION PROFONDE	ISO 10545-6	≤ 175 mm ³	CONFORME CONFORMS GEMÄSS CONFORME
DILATAZIONE TERMICA LINEARE LINEAR THERMAL EXPANSION THERMISCHE DILATATION DILATATION THERMIQUE LINÉAIRE	ISO 10545-8	Requisito non previsto No provision Nicht erforderlich Non prévu	α ≤ 7 x 10⁻⁶ °C⁻¹
RESISTENZA AGLI SBALZI TERMICI THERMAL SHOCK RESISTANCE TEMPERATURWECHSELBESTÄNDIGKEIT RÉSISTANCE AUX CHOCS THERMIQUES	ISO 10545-9	Nessuna alterazione No alterations Keine Änderung Aucune altération	RESISTENTE RESISTANT BESTÄNDIG RÉSISTANT
RESISTENZA ALL'ATTACCO CHIMICO (2) CHEMICAL RESISTANCE (2) CHEMISCHE BESTÄNDIGKEIT (2) RÉSISTANCE CHIMIQUE (2)	ISO 10545-13	Come indicato dal produttore As indicated by manufacturer Wie vom Hersteller angegeben Comme indiqué par le producteur	LA - HA RESISTENTE RESISTANT BESTÄNDIG RÉSISTANT LB - HB (Lux)
RESISTENZA ALLE MACCHIE STAIN RESISTANCE FLECKENBESTÄNDIGKEIT RÉSISTANCE AUX TACHES	ISO 10545-14	Classe 3 min.	5 RESISTENTE RESISTANT BESTÄNDIG RÉSISTANT ≥ 3 (Lux)
RESISTENZA AL GELO FROST RESISTANCE FROSTBESTÄNDIGKEIT RÉSISTANCE AU GEL	ISO 10545-12	Nessuna alterazione No alterations Keine Änderung Aucune altération	RESISTENTE RESISTANT BESTÄNDIG RÉSISTANT
CARATTERISTICHE DIMENSIONALI DIMENSIONS SEITENMASSE CARACTÉRISTIQUES DIMENSIONNELLES	ISO 10545-2	LUNGHEZZA E LARGHEZZA LENGTH AND WIDTH LÄNGE UND BREITE LONGUEUR ET LARGEUR	± 0,3 % max ± 1 mm CONFORME CONFORMS GEMÄSS CONFORME
		RETTILINEITÀ SPIGOLI STRAIGHTNESS OF SIDES KANTENGERADHEIT RECTITUDE DES ARÊTES	± 0,3 % max ± 0,8 mm CONFORME CONFORMS GEMÄSS CONFORME
		ORTOGONALITÀ RECTANGULARITY RECHTWINKLIGKEIT ORTHOGONALITÉ	± 0,3 % max ± 1,5 mm CONFORME CONFORMS GEMÄSS CONFORME
		PLANARITÀ WARPAGE EBENFLÄCHIGKEIT PLANEITÉ	± 0,4 % max ± 1,8 mm CONFORME CONFORMS GEMÄSS CONFORME
		SPESSORE THICKNESS STÄRKE ÉPAISSEUR	± 5 % max ± 0,5 mm CONFORME CONFORMS GEMÄSS CONFORME

(1) Valore riferito al solo materiale ceramico_Value referred to ceramic material only_Der Wert bezieht sich ausschließlich auf keramisches Material_Valeur qui se réfère uniquement au matériel céramique
(2) Ad esclusione dell'acido fluoridrico e suoi derivati_Excluding hydrofluoric acid and its derivatives_Ausgenommen den Fluorwasserstoff und seine Derivate_Sauf l'acide fluorhydrique et ses dérivés
(*) Plus: lastra + fibra di vetro_Plus: slab and fiberglass_Plus: Fliese + Glass-Gewebe_Plus: dalle + fibre de verres

Zero.3 GRES PORCELLANATO LAMINATO_LAMINATED PORCELAIN STONEWARE

Conforme_according to: ANSI A137.3 (unglazed back layered gauged porcelain slabs)

CARATTERISTICHE TECNICHE TECHNICAL FEATURES	METODO DI PROVA TEST METHOD	REQUISITI PRESCRITTI REQUIRED VALUE ANSI A137.3	VALORI MEDI AVERAGE VALUES ZERO.3, 3PLUS*, 5PLUS*, 6mm
ASSORBIMENTO D'ACQUA WATER ABSORPTION	ASTM C373	≤ 0.5%	0.1% (1)
RESISTENZA ALLA FLESSIONE MODULUS OF RUPTURE	ASTM C1505	≥ 6000 lbf	≥ 6000 lbf
CARICO DI ROTTURA BREAKING STRENGTH	ASTM C1505	Thickness 3.5-4.9 mm: ≥ 85 lbf	≥ 85 lbf (Plus 3.5 mm)
		Thickness 5-6.5 mm: ≥ 175 lbf	≥ 175 lbf (Plus 5.5 mm / 6 mm)
RESISTENZA ALL'ABRASIONE PROFONDA DEEP ABRASION RESISTANCE	ASTM C1243	≤ 175 mm ³	CONFORME CONFORMS
DILATAZIONE TERMICA LINEARE LINEAR THERMAL EXPANSION	ASTM C372	Requisito non previsto No provision	α ≤ 8 x 10⁻⁶ °C⁻¹ α ≤ 4.4 x 10⁻⁶ °F⁻¹
RESISTENZA AGLI SBALZI TERMICI THERMAL SHOCK RESISTANCE	ASTM C484	Nessuna alterazione No alterations	RESISTENTE RESISTANT
RESISTENZA ALL'ATTACCO CHIMICO (2) CHEMICAL RESISTANCE (2)	ASTM C650	Come indicato dal produttore As indicated by manufacturer	A RESISTENTE RESISTANT C (Lux)
RESISTENZA ALLE MACCHIE STAIN RESISTANCE	ASTM C1378	Come indicato dal produttore As indicated by manufacturer	A RESISTENTE RESISTANT C (Lux)
RESISTENZA AL GELO FROST RESISTANCE	ASTM C1026	Come indicato dal produttore As indicated by manufacturer	RESISTENTE RESISTANT
CARATTERISTICHE DIMENSIONALI DIMENSIONS	ASTM C499	DIMENSIONI NOMINALI NOMINAL DIMENSIONS	Max ±3.0% of nominal dimensions CONFORME CONFORMS
		INTERVALLO CALIBRO CALIBER RANGE	Max ±0.25% or max ±0.03" CONFORME CONFORMS
		SPESSORE THICKNESS	Max ±0.5 mm (±0.02") from nominal thickness CONFORME CONFORMS
		VARIAZIONE SPESSORE THICKNESS VARIATION	0.5 mm (0.02") CONFORME CONFORMS
		PARALLELISMO DEI LATI WEDGING	Max ±0.25% or max ±0.03" CONFORME CONFORMS

(1) Valore riferito al solo materiale ceramico_Value referred to ceramic material only
(2) Ad esclusione dell'acido fluoridrico e suoi derivati_Excluding hydrofluoric acid and its derivatives
(*) Plus: lastra + fibra di vetro_Plus: slab and fiberglass

Caratteristiche tecniche

Technical features_Technische Eigenschaften_Caractéristiques techniques

GRES PORCELLANATO_PORCELAIN TILES_FEINSTEINZEUG_GRÈS CÉRAMÉ

Conforme_according to_Gemäß_conforme: **ISO 13006 G - EN 14411 G Gruppo/Group BIA**

CARATTERISTICHE TECNICHE TECHNICAL FEATURES TECHNISCHE EIGENSCHAFTEN CARACTÉRISTIQUES TECHNIQUES	METODO DI PROVA TEST METHOD PRÜFMETHODE MÉTHODE D'ESSAI	REQUISITI PRESCRITTI REQUIRED VALUE VORGESCHRIEBENER WERT VALEUR REQUISE ISO 13006-G EN 14411-G Gruppo Bia	VALORI MEDI AVERAGE VALUES DURCHSCHNITTLICHE WERTE VALEURS MOYENNES Non smaltato Unglazed UGL	VALORI MEDI AVERAGE VALUES DURCHSCHNITTLICHE WERTE VALEURS MOYENNES Levigato Polished Lappato UGL	VALORI MEDI AVERAGE VALUES DURCHSCHNITTLICHE WERTE VALEURS MOYENNES Smaltato Glazed GL
ASSORBIMENTO D'ACQUA WATER ABSORPTION WASSERABSORPTION ABSORPTION D'EAU	ISO 10545-3	≤ 0,5%	0,05%	0,05%	0,05%
RESISTENZA ALLA FLESSIONE MODULUS OF RUPTURE BIEGEFESTIGKEIT RÉSISTANCE À LA FLEXION	ISO 10545-4	≥ 35 N/mm ²	50 N/mm²	50 N/mm²	50 N/mm²
SFORZO DI ROTTURA (S) BREAKING STRENGTH (S) BRUCHLAST (S) CHARGE DE RUPTURE (S)	ISO 10545-4	≥ 1300 N	CONFORME CONFORMS GEMÄSS CONFORME	CONFORME CONFORMS GEMÄSS CONFORME	CONFORME CONFORMS GEMÄSS CONFORME
RESISTENZA ALL'ABRASIONE PROFONDA DEEP ABRASION RESISTANCE WIDERSTAND GEGEN TIEFENABRIEB RÉSISTANCE À L'ABRASION PROFONDE	ISO 10545-6	≤ 175 mm ³	145 mm³	145 mm³	NON APPLICABILE NOT APPLICABLE NON APPLICABLE NICHT ANWENDBAR
DILATAZIONE TERMICA LINEARE LINEAR THERMAL EXPANSION THERMISCHE DILATATION DILATATION THERMIQUE LINÉAIRE	ISO 10545-8	Requisito non previsto No provision Nicht erforderlich Non prévu	α ≤ 7 x 10⁻⁶ °C⁻¹	α ≤ 7 x 10⁻⁶ °C⁻¹	α ≤ 7 x 10⁻⁶ °C⁻¹
RESISTENZA AGLI SBALZI TERMICI THERMAL SHOCK RESISTANCE TEMPERATURWECHSELBESTÄNDIGKEIT RÉSISTANCE AUX CHOCS THERMIQUES	ISO 10545-9	Nessuna alterazione No alterations Keine Änderung Aucune alteration	RESISTENTE RESISTANT BESTÄNDIG RÉSISTANT	RESISTENTE RESISTANT BESTÄNDIG RÉSISTANT	RESISTENTE RESISTANT BESTÄNDIG RÉSISTANT
RESISTENZA AL CAVILLO CRAZING RESISTANCE HAARISSEBESTÄNDIGKEIT RÉSISTANCE AU TRESSILLAGE	ISO 10545-11	Nessuna alterazione No alterations Keine Änderung Aucune alteration	NON APPLICABILE NOT APPLICABLE NICHT ANWENDBAR NON APPLICABLE	NON APPLICABILE NOT APPLICABLE NICHT ANWENDBAR NON APPLICABLE	RESISTENTE RESISTANT BESTÄNDIG RÉSISTANT
RESISTENZA ALL'ATTACCO CHIMICO (1) CHEMICAL RESISTANCE (1) CHEMISCHE BESTÄNDIGKEIT (1) RÉSISTANCE CHIMIQUE (1)	ISO 10545-13	Come indicato dal produttore As indicated by manufacturer Wie vom Hersteller angegeben Comme indiqué par le producteur	LA - HA RESISTENTE RESISTANT BESTÄNDIG RÉSISTANT	LA - HA RESISTENTE RESISTANT BESTÄNDIG RÉSISTANT	LA - HA RESISTENTE RESISTANT BESTÄNDIG RÉSISTANT
RESISTENZA ALLE MACCHIE STAIN RESISTANCE FLECKENBESTÄNDIGKEIT RÉSISTANCE AUX TACHES	ISO 10545-14	Classe 3 min.	5 RESISTENTE RESISTANT BESTÄNDIG RÉSISTANT	5 RESISTENTE RESISTANT BESTÄNDIG RÉSISTANT	5 RESISTENTE RESISTANT BESTÄNDIG RÉSISTANT
CESSIONE DI PIOMBO E CADMIO LEAD AND CADMIUM GIVEN OFF ABGABE VON KADMIIUM UND BLEI DÉGAGEMENT DE CADMIUM ET PLOMB	ISO 10545-15	Requisito non previsto No provision Nicht erforderlich Non prévu	NON APPLICABILE NOT APPLICABLE NICHT ANWENDBAR NON APPLICABLE	NON APPLICABILE NOT APPLICABLE NICHT ANWENDBAR NON APPLICABLE	RESISTENTE RESISTANT BESTÄNDIG RÉSISTANT
RESISTENZA AL GELO FROST RESISTANCE FROSTBESTÄNDIGKEIT RÉSISTANCE AU GEL	ISO 10545-12	Nessuna alterazione No alterations Keine Änderung Aucune alteration	RESISTENTE RESISTANT BESTÄNDIG RÉSISTANT	RESISTENTE RESISTANT BESTÄNDIG RÉSISTANT	RESISTENTE RESISTANT BESTÄNDIG RÉSISTANT
CARATTERISTICHE DIMENSIONALI DIMENSIONS SEITENMASSE CARACTÉRISTIQUES DIMENSIONNELLES	ISO 10545-2	LUNGHEZZA E LARGHEZZA LENGTH AND WIDTH LÄNGE UND BREITE LONGUEUR ET LARGEUR Non rettificato / Not rectified / Nicht Rektifiziert / Non Rectifié ± 0,6% max ± 2 mm Rettificato / Rectified / Rektifiziert / Rectifié ± 0,3% max ± 1 mm	CONFORME CONFORMS GEMÄSS CONFORME	CONFORME CONFORMS GEMÄSS CONFORME	CONFORME CONFORMS GEMÄSS CONFORME
RETTLINEITÀ SPIGOLI STRAIGHTNESS OF SIDES KANTENGERADHEIT RECTITUDE DES ARÊTES		Non rettificato / Not rectified / Nicht Rektifiziert / Non Rectifié ± 0,5% max ± 1,5 mm Rettificato / Rectified / Rektifiziert / Rectifié ± 0,3% max ± 0,8 mm	CONFORME CONFORMS GEMÄSS CONFORME	CONFORME CONFORMS GEMÄSS CONFORME	CONFORME CONFORMS GEMÄSS CONFORME
ORTOGONALITÀ RECTANGULARITY RECHTWINKLIGKEIT ORTHOGONALITÉ		Non rettificato / Not rectified / Nicht Rektifiziert / Non Rectifié ± 0,5% max ± 2 mm Rettificato / Rectified / Rektifiziert / Rectifié ± 0,3% max ± 1,5 mm	CONFORME CONFORMS GEMÄSS CONFORME	CONFORME CONFORMS GEMÄSS CONFORME	CONFORME CONFORMS GEMÄSS CONFORME
PLANARITÀ WARPAGE EBENFLÄCHIGKEIT PLANÉITÉ		Non rettificato / Not rectified / Nicht Rektifiziert / Non Rectifié ± 0,5% max ± 2 mm Rettificato / Rectified / Rektifiziert / Rectifié ± 0,4% max ± 1,8 mm	CONFORME CONFORMS GEMÄSS CONFORME	CONFORME CONFORMS GEMÄSS CONFORME	CONFORME CONFORMS GEMÄSS CONFORME
SPESSORE THICKNESS STÄRKE ÉPAISSEUR		± 5% max ± 0,5 mm	CONFORME CONFORMS GEMÄSS CONFORME	CONFORME CONFORMS GEMÄSS CONFORME	CONFORME CONFORMS GEMÄSS CONFORME

(1) Ad esclusione dell'acido fluoridrico e suoi derivati_Excluding hydrofluoric acid and its derivatives_Ausgenommen den Fluorwasserstoff und seine Derivate_Sauf l'acide fluorhydrique et ses dérivés

GRES PORCELLANATO_PORCELAIN TILES

Conforme_according to: **ANSI A137.1 (glazed and unglazed porcelain tiles - P1 Class)**

CARATTERISTICHE TECNICHE TECHNICAL FEATURES	METODO DI PROVA TEST METHOD	REQUISITI PRESCRITTI REQUIRED VALUE ANSI A137.1 Porcelain Tiles P1 Class	VALORI MEDI AVERAGE VALUES Non smaltato Unglazed UGL	VALORI MEDI AVERAGE VALUES Levigato Polished Lappato UGL	VALORI MEDI AVERAGE VALUES Smaltato Glazed GL
ASSORBIMENTO D'ACQUA WATER ABSORPTION	ASTM C373	≤ 0.5%	0.05%	0.05%	0.05%
SFORZO DI ROTTURA BREAKING STRENGTH	ASTM C648	≥ 250 lbf	CONFORME CONFORMS	CONFORME CONFORMS	CONFORME CONFORMS
RESISTENZA ALL'ABRASIONE PROFONDA DEEP ABRASION RESISTANCE	ASTM C1243	≤ 175 mm ³	145 mm³	145 mm³	NON APPLICABILE NOT APPLICABLE
DILATAZIONE TERMICA LINEARE LINEAR THERMAL EXPANSION	ASTM C372	Requisito non previsto No provision	α ≤ 8 X 10⁻⁶ °C⁻¹ α ≤ 4.4 X 10⁻⁶ °F⁻¹	α ≤ 8 X 10⁻⁶ °C⁻¹ α ≤ 4.4 X 10⁻⁶ °F⁻¹	α ≤ 8 X 10⁻⁶ °C⁻¹ α ≤ 4.4 X 10⁻⁶ °F⁻¹
RESISTENZA AGLI SBALZI TERMICI THERMAL SHOCK RESISTANCE	ASTM C484	Nessuna alterazione No alterations	RESISTENTE RESISTANT	RESISTENTE RESISTANT	RESISTENTE RESISTANT
RESISTENZA AL CAVILLO CRAZING RESISTANCE	ASTM C424	Nessuna alterazione No alterations	NON APPLICABILE NOT APPLICABLE	NON APPLICABILE NOT APPLICABLE	RESISTENTE RESISTANT
RESISTENZA ALL'ATTACCO CHIMICO (1) CHEMICAL RESISTANCE (1)	ASTM C650	Come indicato dal produttore As indicated by manufacturer	A RESISTENTE RESISTANT	A RESISTENTE RESISTANT	A RESISTENTE RESISTANT
RESISTENZA ALLE MACCHIE STAIN RESISTANCE	ASTM C1378	Come indicato dal produttore As indicated by manufacturer	A RESISTENTE RESISTANT	A RESISTENTE RESISTANT C (Lux)	A RESISTENTE RESISTANT
CESSIONE DI PIOMBO E CADMIO LEAD AND CADMIUM GIVEN OFF	ASTM C895	Requisito non previsto No provision	NON APPLICABILE NOT APPLICABLE	NON APPLICABILE NOT APPLICABLE	RESISTENTE RESISTANT
RESISTENZA AL GELO FROST RESISTANCE	ASTM C1026	Come indicato dal produttore As indicated by manufacturer	RESISTENTE RESISTANT	RESISTENTE RESISTANT	RESISTENTE RESISTANT
RESISTENZA AL DISTACCO DA MALTA STANDARD BOND STRENGTH	ASTM C482	≥ 50 PSI	CONFORME CONFORMS	CONFORME CONFORMS	CONFORME CONFORMS
CARATTERISTICHE DIMENSIONALI DIMENSIONS	ASTM C485	PLANARITÀ DEI LATI EDGE WARPAGE Rettificato / Rectified ± 0.40% or max ± 0.05" for tiles up to 24"x24" or max ± 0.07" for tiles larger than 24"x24" Calibrato / Calibrated ± 0.75% or max ± 0.09"	CONFORME CONFORMS	CONFORME CONFORMS	CONFORME CONFORMS
RETTLINEITÀ SPIGOLI STRAIGHTNESS OF SIDES KANTENGERADHEIT RECTITUDE DES ARÊTES		PLANARITÀ DIAGONALI DIAGONAL WARPAGE Rettificato / Rectified ± 0.40% or max ± 0.07"	CONFORME CONFORMS	CONFORME CONFORMS	CONFORME CONFORMS
ORTOGONALITÀ RECTANGULARITY RECHTWINKLIGKEIT ORTHOGONALITÉ		DIMENSIONI NOMINALI NOMINAL DIMENSIONS Rettificato / Rectified - 3.0% / +2.0% of nominal dimensions Calibrato / Calibrated ± 3.0% of nominal dimensions	CONFORME CONFORMS	CONFORME CONFORMS	CONFORME CONFORMS
PLANARITÀ WARPAGE EBENFLÄCHIGKEIT PLANÉITÉ		INTERVALLO CALIBRO CALIBER RANGE Rettificato / Rectified ± 0.25% or max ± 0.03" Calibrato / Calibrated ± 0.50% or max ± 0.08"	CONFORME CONFORMS	CONFORME CONFORMS	CONFORME CONFORMS
SPESSORE THICKNESS		SPESSORE THICKNESS ≤ 0.040" Calibrato / Calibrated ± 0.50% or max ± 0.08"	CONFORME CONFORMS	CONFORME CONFORMS	CONFORME CONFORMS
PARALLELISMO DEI LATI WEDGING		PARALLELISMO DEI LATI WEDGING Rettificato / Rectified ± 0.25% or max ± 0.03" Calibrato / Calibrated ± 0.50% or max ± 0.08"	CONFORME CONFORMS	CONFORME CONFORMS	CONFORME CONFORMS















(1) Ad esclusione dell'acido fluoridrico e suoi derivati_Excluding hydrofluoric acid and its derivatives

Caratteristiche tecniche

Technical features_Technische Eigenschaften_Caractéristiques techniques

RIVESTIMENTO MONOPOROSA_SINGLE FIRED WALL TILES_GLASIERTES STEINGUT_REVÊTEMENT MONOCUISSON











Conforme_according to_Gemäß_conforme: **ISO 13006 L - EN 14411 L Gruppo/Group BIII - GL**

CARATTERISTICHE TECNICHE TECHNICAL FEATURES TECHNISCHE EIGENSCHAFTEN CARACTÉRISTIQUES TECHNIQUES	METODO DI PROVA TEST METHOD PRÜFMETHODE MÉTHODE D'ESSAI	REQUISITI PRESCRITTI REQUIRED VALUE VORGESCHRIEBENER WERT VALEUR REQUISE ISO 13006-L-EN 14411-L Gruppo/ Group BIII GL	VALORI MEDI AVERAGE VALUES DURCHSCHNITTLICHE WERTE VALEURS MOYENNES Smaltato/ Glazed BIII GL
 ASSORBIMENTO D'ACQUA WATER ABSORPTION WASSERABSORPTION ABSORPTION D'EAU	ISO 10545-3	> 10%	> 10%
 RESISTENZA ALLA FLESSIONE BENDING STRENGTH BIEGEFESTIGKEIT RÉSISTANCE À LA FLEXION	ISO 10545-4	≥ 12 N/mm ²	18 N/mm ²
 SFORZO DI ROTTURA (S) BREAKING STRENGTH (S) BRUCHLAST (S) CHARGE DE RUPTURE (S)	ISO 10545-4	≥ 600 N	≥ 600 N
 DILATAZIONE TERMICA LINEARE LINEAR THERMAL EXPANSION THERMISCHE DILATATION DILATATION THERMIQUE LINÉAIRE	ISO 10545-8	Requisito non previsto No provision Nicht erforderlich Non prévu	$\alpha \leq 7 \times 10^{-6} \text{ } ^\circ\text{C}^{-1}$
 RESISTENZA AGLI SBALZI TERMICI THERMAL SHOCK RESISTANCE TEMPERATURWECHSELBESTÄNDIGKEIT RÉSISTANCE AUX CHOCS THERMIQUES	ISO 10545-9	Nessuna alterazione No alterations Keine Änderung Aucune altération	RESISTENTE RESISTANT BESTÄNDIG RÉSISTANT
 RESISTENZA AL CAVILLO CRAZING RESISTANCE HAARISBESTÄNDIGKEIT RÉSISTANCE AU TRESSILLAGE	ISO 10545-11	Nessuna alterazione No alterations Keine Änderung Aucune altération	RESISTENTE RESISTANT BESTÄNDIG RÉSISTANT
 RESISTENZA ALL'ATTACCO CHIMICO (1) CHEMICAL RESISTANCE (1) CHEMISCHE BESTÄNDIGKEIT (1) RÉSISTANCE CHIMIQUE (1)	ISO 10545-13	Come indicato dal produttore As indicated by manufacturer Wie vom Hersteller angegeben Comme indiqué par le producteur	LA - HA RESISTENTE RESISTANT BESTÄNDIG RÉSISTANT
 RESISTENZA ALLE MACCHIE STAIN RESISTANCE FLECKENBESTÄNDIGKEIT RÉSISTANCE AUX TACHES	ISO 10545-14	Classe 3 min.	5 RESISTENTE RESISTANT BESTÄNDIG RÉSISTANT
 CESSIONE DI PIOMBO E CADMIO LEAD AND CADMIUM GIVEN OFF ABGABE VON KADMIIUM UND BLEI DÉGAGEMENT DE CADMIUM ET PLOMB	ISO 10545-15	Requisito non previsto No provision Nicht erforderlich Non prévu	RESISTENTE RESISTANT BESTÄNDIG RÉSISTANT
 RESISTENZA AL GELO FROST RESISTANCE FROSTBESTÄNDIGKEIT RÉSISTANCE AU GEL	ISO 10545-12	Come indicato dal produttore As indicated by manufacturer Wie vom Hersteller angegeben Comme indiqué par le producteur	NON RESISTENTE NOT RESISTANT NICHT BESTÄNDIG PAS RÉSISTANT
 CARATTERISTICHE DIMENSIONALI DIMENSIONS SEITENMASSE CARACTÉRISTIQUES DIMENSIONNELLES	ISO 10545-2	LUNGHEZZA E LARGHEZZA LENGTH AND WIDTH LÄNGE UND BREITE LONGUEUR ET LARGEUR Non rettificato / Not rectified / Nicht Rektifiziert / Non Rectifié ± 0,6 % max ± 2 mm Rettificato / Rectified / Rektifiziert / Rectifié ± 0,3 % max ± 1 mm	CONFORME CONFORMS GEMÄSS CONFORME
 RETTILINEITÀ SPIGOLI STRAIGHTNESS OF SIDES KANTENGERADHEIT RECTITUDE DES ARÊTES		Non rettificato / Not rectified / Nicht Rektifiziert / Non Rectifié ± 0,5 % max ± 1,5 mm Rettificato / Rectified / Rektifiziert / Rectifié ± 0,3 % max ± 0,8 mm	CONFORME CONFORMS GEMÄSS CONFORME
 ORTOGONALITÀ RECTANGULARITY RECHTWINKLIGKEIT ORTHOGONALITÉ		Non rettificato / Not rectified / Nicht Rektifiziert / Non Rectifié ± 0,5 % max ± 2 mm Rettificato / Rectified / Rektifiziert / Rectifié ± 0,3 % max ± 1,5 mm	CONFORME CONFORMS GEMÄSS CONFORME
 PLANARITÀ WARPAGE EBENFLÄCHIGKEIT PLANÉITÉ		Non rettificato / Not rectified / Nicht Rektifiziert / Non Rectifié ± 0,5 % max ± 2 mm Rettificato / Rectified / Rektifiziert / Rectifié ± 0,4 % max ± 1,8 mm	CONFORME CONFORMS GEMÄSS CONFORME
 SPESSORE THICKNESS STÄRKE ÉPAISSEUR		± 10 % max ± 0,5 mm	CONFORME CONFORMS GEMÄSS CONFORME

(1) Ad esclusione dell'acido fluoridrico e suoi derivati_Excluding hydrofluoric acid and its derivatives_Ausgenommen den Fluorwasserstoff und seine Derivate_Sauf l'acide fluorhydrique et ses dérivés

RIVESTIMENTO MONOPOROSA_SINGLE FIRED WALL TILES

Conforme_according to: **ANSI A137.1 (glazed wall tiles - P4 Class)**

CARATTERISTICHE TECNICHE TECHNICAL FEATURES	METODO DI PROVA TEST METHOD	REQUISITI PRESCRITTI REQUIRED VALUE ANSI A137.1 wall tiles P4 Class	VALORI MEDI AVERAGE VALUES Smaltato Glazed - GL
 ASSORBIMENTO D'ACQUA WATER ABSORPTION	ASTM C373	7% < e ≤ 20%	7% < e ≤ 20%
 SFORZO DI ROTTURA BREAKING STRENGTH	ASTM C648	≥ 125 lbf	≥ 125 lbf
 DILATAZIONE TERMICA LINEARE LINEAR THERMAL EXPANSION	ASTM C372	Requisito non previsto No provision	$\alpha \leq 8 \times 10^{-6} \text{ } ^\circ\text{C}^{-1}$ $\alpha \leq 4.4 \times 10^{-6} \text{ } ^\circ\text{F}^{-1}$
 RESISTENZA AGLI SBALZI TERMICI THERMAL SHOCK RESISTANCE	ASTM C484	Nessuna alterazione No alterations	RESISTENTE RESISTANT
 RESISTENZA AL CAVILLO CRAZING RESISTANCE	ASTM C424	Nessuna alterazione No alterations	RESISTENTE RESISTANT
 RESISTENZA ALL'ATTACCO CHIMICO (1) CHEMICAL RESISTANCE (1)	ASTM C650	Come indicato dal produttore As indicated by manufacturer	A RESISTENTE RESISTANT
 RESISTENZA ALLE MACCHIE STAIN RESISTANCE	ASTM C1378	Come indicato dal produttore As indicated by manufacturer	A RESISTENTE RESISTANT
 CESSIONE DI PIOMBO E CADMIO LEAD AND CADMIUM GIVEN OFF	ASTM C895	Requisito non previsto No provision	RESISTENTE RESISTANT
 RESISTENZA AL GELO FROST RESISTANCE	ASTM C1026	Come indicato dal produttore As indicated by manufacturer	NON RESISTENTE NOT RESISTANT
 RESISTENZA AL DISTACCO DA MALTA STANDARD BOND STRENGTH	ASTM C482	≥ 50 PSI	CONFORME CONFORMS
 CARATTERISTICHE DIMENSIONALI DIMENSIONS	ASTM C485	PLANARITÀ DEI LATI EDGE WARPAGE Rettificato / Rectified - 0.30% / + 0.40% or max - 0.04" / +0.05" Calibrato / Calibrated - 0.30% / + 0.40% or max - 0.04" / +0.05"	CONFORME CONFORMS
		PLANARITÀ DIAGONALI DIAGONAL WARPAGE Rettificato / Rectified - 0.30% / + 0.40% or max - 0.05" / +0.07" Calibrato / Calibrated - 0.30% / + 0.40% or max - 0.05" / +0.07"	CONFORME CONFORMS
		DIMENSIONI NOMINALI NOMINAL DIMENSIONS Rettificato / Rectified ±2.0% of nominal dimensions Calibrato / Calibrated ±2.0% of nominal dimensions	± 1.0%
		INTERVALLO CALIBRO CALIBER RANGE Rettificato / Rectified ± 0.25% or max ± 0.03" Calibrato / Calibrated ± 0.30% or max ± 0.04"	CONFORME CONFORMS
		SPESSORE THICKNESS ≤ 0.031" ≤ 0.031"	CONFORME CONFORMS
		PARALLELISMO DEI LATI WEDGING Rettificato / Rectified ± 0.25% or max ± 0.03" Calibrato / Calibrated ± 0.40% or max ± 0.05"	CONFORME CONFORMS















(1) Ad esclusione dell'acido fluoridrico e suoi derivati_Excluding hydrofluoric acid and its derivatives

Caratteristiche tecniche

Technical features_Technische Eigenschaften_Caractéristiques techniques

20 mm GRES PORCELLANATO_PORCELAIN TILES_FEINSTEINZEUG_GRÈS CÉRAMÉ















Conforme_according to_Gemäß_conforme: **ISO 13006 G - EN 14411 G Gruppo/Group BIA**

CARATTERISTICHE TECNICHE TECHNICAL FEATURES TECHNISCHE EIGENSCHAFTEN CARACTÉRISTIQUES TECHNIQUES	METODO DI PROVA TEST METHOD PRÜFMETHODE MÉTHODE D'ESSAI	REQUISITI PRESCRITTI REQUIRED VALUE VORGESCHRIEBENER WERT VALEUR REQUISE ISO 13006-G EN 14411-G Gruppo Bia	VALORI MEDI AVERAGE VALUES DURCHSCHNITTliche WERTE VALEURS MOYENNES Non smaltato Unglazed UGL
 ASSORBIMENTO D'ACQUA WATER ABSORPTION WASSERABSORPTION ABSORPTION D'EAU	ISO 10545-3	≤ 0,5%	0,05%
 RESISTENZA ALLA FLESSIONE MODULUS OF RUPTURE BIEGEFESTIGKEIT RÉSISTANCE À LA FLEXION	ISO 10545-4	≥ 35 N/mm ²	50 N/mm²
 SFORZO DI ROTTURA (S) BREAKING STRENGTH (S) BRUCHLAST (S) CHARGE DE RUPTURE (S)	ISO 10545-4	≥ 1300 N	13600 N
 CLASSE REQUISITI MECCANICI MECHANICAL CLASSIFICATION KLASSE MECHANISCHES ERFORDERNIS RÉSISTANCE MÉCANIQUE	EN 1339-F	Requisito non previsto No provision Nicht erforderlich Non prévu	U14 (2)
 RESISTENZA ALL'ABRASIONE PROFONDA DEEP ABRASION RESISTANCE WIDERSTAND GEGEN TIEFENABRIEB RÉSISTANCE À L'ABRASION PROFONDE	ISO 10545-6	≤ 175 mm ³	145 mm³
 DILATAZIONE TERMICA LINEARE LINEAR THERMAL EXPANSION THERMISCHE DILATATION DILATATION THERMIQUE LINÉAIRE	ISO 10545-8	Requisito non previsto No provision Nicht erforderlich Non prévu	α ≤ 7 X 10⁻⁶ °C⁻¹
 RESISTENZA AGLI SBALZI TERMICI THERMAL SHOCK RESISTANCE TEMPERATURWECHSELBESTÄNDIGKEIT RÉSISTANCE AUX CHOCS THERMIQUES	ISO 10545-9	Nessuna alterazione No alterations Keine Änderung Aucune altération	RESISTENTE RESISTANT BESTÄNDIG RÉSISTANT
 RESISTENZA ALL'ATTACCO CHIMICO (1) CHEMICAL RESISTANCE (1) CHEMISCHE BESTÄNDIGKEIT (1) RÉSISTANCE CHIMIQUE (1)	ISO 10545-13	Come indicato dal produttore As indicated by manufacturer Wie vom Hersteller angegeben Comme indiqué par le producteur	LA - HA RESISTENTE RESISTANT BESTÄNDIG RÉSISTANT
 RESISTENZA ALLE MACCHIE STAIN RESISTANCE FLECKENBESTÄNDIGKEIT RÉSISTANCE AUX TÂCHES	ISO 10545-14	Classe 3 min.	5 RESISTENTE RESISTANT BESTÄNDIG RÉSISTANT
 RESISTENZA AL GELO FROST RESISTANCE FROSTBESTÄNDIGKEIT RÉSISTANCE AU GEL	ISO 10545-12	Nessuna alterazione No alterations Keine Änderung Aucune altération	RESISTENTE RESISTANT BESTÄNDIG RÉSISTANT
 CARATTERISTICHE DIMENSIONALI DIMENSIONS SEITENMASSE CARACTÉRISTIQUES DIMENSIONNELLES	ISO 10545-2	LUNGHEZZA E LARGHEZZA LENGTH AND WIDTH LÄNGE UND BREITE LONGUEUR ET LARGEUR Non rettificato / Not rectified / Nicht Rektifiziert / Non Rectifié ± 0,6% max ± 2 mm Rettificato / Rectified / Rektifiziert / Rectifié ± 0,3% max ± 1 mm	CONFORME CONFORMS GEMÄSS CONFORME
 RETILINEITÀ SPIGOLI STRAIGHTNESS OF SIDES KANTENGERADHEIT RECTITUDE DES ARÊTES		Non rettificato / Not rectified / Nicht Rektifiziert / Non Rectifié ± 0,5% max ± 1,5 mm Rettificato / Rectified / Rektifiziert / Rectifié ± 0,3 % max ± 0,8 mm	CONFORME CONFORMS GEMÄSS CONFORME
 ORTOGONALITÀ RECTANGULARITY RECHTWINKLIGKEIT ORTHOGONALITÉ		Non rettificato / Not rectified / Nicht Rektifiziert / Non Rectifié ± 0,5 % max ± 2 mm Rettificato / Rectified / Rektifiziert / Rectifié ± 0,3 % max ± 1,5 mm	CONFORME CONFORMS GEMÄSS CONFORME
 PLANARITÀ WARPAGE EBENFLÄCHIGKEIT PLANÉITÉ		Non rettificato / Not rectified / Nicht Rektifiziert / Non Rectifié ± 0,5 % max ± 2 mm Rettificato / Rectified / Rektifiziert / Rectifié ± 0,4 % max ± 1,8 mm	CONFORME CONFORMS GEMÄSS CONFORME
 SPESSORE THICKNESS STÄRKE ÉPAISSEUR		± 5% max ± 0,5 mm	CONFORME CONFORMS GEMÄSS CONFORME

(1) Ad esclusione dell'acido fluoridrico e suoi derivati_Excluding hydrofluoric acid and its derivatives_Ausgenommen den Fluorwasserstoff und seine Derivate_Sauf l'acide fluorhydrique et ses dérivés
(2) Carrabile quando incollata su massetto. La classificazione si riferisce al solo formato quadrato (fino a 60x60 cm)._Transitable when applied to a screed with adhesive. This information applies only to square formats (up to 60x60 cm)._Fahrbar bei Verkleben auf Estrich. Diese Information bezieht sich nur auf quadratische Formate (bis zu 60x60 cm)._Praticable après collage sur chapebe. Cette information n'est valable que pour les formats carrés (jusqu'a 60x60 cm).

20 mm GRES PORCELLANATO_PORCELAIN TILES

Conforme_according to: **ANSI A137.1 (unglazed porcelain tiles - P1 Class)**

CARATTERISTICHE TECNICHE TECHNICAL FEATURES	METODO DI PROVA TEST METHOD	REQUISITI PRESCRITTI REQUIRED VALUE ANSI A137.1 Unglazed Porcelain Tiles P1 Class	VALORI MEDI AVERAGE VALUES Non smaltato Unglazed UGL
 ASSORBIMENTO D'ACQUA WATER ABSORPTION	ASTM C373	≤ 0.5%	0.05%
 SFORZO DI ROTTURA BREAKING STRENGTH	ASTM C648	≥ 250 lbf	2800 lbf
 RESISTENZA ALL'ABRASIONE PROFONDA DEEP ABRASION RESISTANCE	ASTM C1243	≤ 175 mm ³	145 mm³
 DILATAZIONE TERMICA LINEARE LINEAR THERMAL EXPANSION	ASTM C372	Requisito non previsto No provision	α ≤ 8 X 10⁻⁶ °C⁻¹ α ≤ 4.4 X 10⁻⁶ °F⁻¹
 RESISTENZA AGLI SBALZI TERMICI THERMAL SHOCK RESISTANCE	ASTM C484	Nessuna alterazione No alterations	RESISTENTE RESISTANT
 RESISTENZA ALL'ATTACCO CHIMICO (1) CHEMICAL RESISTANCE (1)	ASTM C650	Come indicato dal produttore As indicated by manufacturer	A RESISTENTE RESISTANT
 RESISTENZA ALLE MACCHIE STAIN RESISTANCE	ASTM C1378	Come indicato dal produttore As indicated by manufacturer	A RESISTENTE RESISTANT
 RESISTENZA AL GELO FROST RESISTANCE	ASTM C1026	Come indicato dal produttore As indicated by manufacturer	CONFORME CONFORMS
 RESISTENZA AL DISTACCO DA MALTA STANDARD BOND STRENGTH	ASTM C482	≥ 50 PSI	CONFORME CONFORMS
 CARATTERISTICHE DIMENSIONALI DIMENSIONS	ASTM C485	PLANARITÀ DEI LATI EDGE WARPAGE Rettificato / Rectified ± 0.40% or max ± 0.05" for tiles up to 24"x24" or max ± 0.07" for tiles larger than 24"x24"	CONFORME CONFORMS
 CARATTERISTICHE DIMENSIONALI DIMENSIONS		PLANARITÀ DIAGONALI DIAGONAL WARPAGE Rettificato / Rectified ± 0.40% or max ± 0.07"	CONFORME CONFORMS
 CARATTERISTICHE DIMENSIONALI DIMENSIONS		DIMENSIONI NOMINALI NOMINAL DIMENSIONS Rettificato / Rectified - 3.0% / +2.0% of nominal dimensions	± 1.5%
 CARATTERISTICHE DIMENSIONALI DIMENSIONS		INTERVALLO CALIBRO CALIBER RANGE Rettificato / Rectified ± 0.25% or max ± 0.03"	CONFORME CONFORMS
 SPESSORE THICKNESS		≤ 0.040"	≤ 0.030"
 PARALLELISMO DEI LATI WEDGING		Rettificato / Rectified ± 0.25% or max ± 0.03"	CONFORME CONFORMS



(1) Ad esclusione dell'acido fluoridrico e suoi derivati_Excluding hydrofluoric acid and its derivatives

Caratteristiche di sicurezza e termiche

Safety and thermal features_Sicherheit und Thermische Eigenschaften_Caractéristiques de sécurité et thermique

Zero.3 GRES PORCELLANATO LAMINATO_LAMINATED PORCELAIN STONEWARE_LAMINIERTES FEINSTEINZEUG_GRÈS LAMINÉ

REAZIONE AL FUOCO_FIRE REACTION_FEUERREAKTION_RÉACTION AU FEU

CARATTERISTICHE TECNICHE TECHNICAL FEATURES TECHNISCHE EIGENSCHAFTEN CARACTÉRISTIQUES TECHNIQUES	METODO DI PROVA TEST METHOD PRÜFMETHODE MÉTHODE D'ESSAI	RIFERIMENTI PER LA CLASSIFICAZIONE REFERENCES FOR THE CLASSIFICATION REFERENZEN FÜR DIE EINSTUFUNG RÉFÉRENCES POUR LE CLASEMENT	VALORI VALUES WERTE VALEURS	VALORI VALUES WERTE VALEURS
 REAZIONE AL FUOCO FIRE REACTION FEUERREAKTION RÉACTION AU FEU	EN 13823 EN 9239-1		ZERO.3, 6mm	ZERO.3 PLUS, 5 PLUS*
			Classe A1_R Posa a pavimento Floor installation Bodeninstallation Pose au sol	Classe A1_R - s1 Posa a pavimento Floor installation Bodeninstallation Pose au sol
			Classe A1 Posa a parete Wall installation Wandinstallation Pose au mur	Classe A2 - s1, d0 Posa a parete Wall installation Wandinstallation Pose au mur
 FLAME SPREAD	ASTM E84		Class A	Class A



CARATTERISTICHE TERMICHE_THERMAL FEATURES_THERMISCHE EIGENSCHAFTEN_CARACTÉRISTIQUES THERMIQUES

 CONDUCIBILITÀ TERMICA THERMAL CONDUCTIVITY WÄRMELEITFÄHIGKEIT CONDUCTIBILITÉ THERMIQUE	EN 12524	-	α = 1,3 W/m²K α = 0.7 Btu/ft h°F	α = 1,3 W/m²K α = 0.7 Btu/ft h°F
--	----------	---	---	---

(* Plus: lastra + fibra di vetro_Plus: slab and fiberglass_Plus: Fliese + Glass- Gewebe_Plus: dalle + fibre de verres

GRES PORCELLANATO_PORCELAIN TILES_FEINSTEINZEUG_GRÈS CÉRAME

REAZIONE AL FUOCO_FIRE REACTION_FEUERREAKTION_RÉACTION AU FEU



CARATTERISTICHE TECNICHE TECHNICAL FEATURES TECHNISCHE EIGENSCHAFTEN CARACTÉRISTIQUES TECHNIQUES	METODO DI PROVA TEST METHOD PRÜFMETHODE MÉTHODE D'ESSAI	RIFERIMENTI PER LA CLASSIFICAZIONE REFERENCES FOR THE CLASSIFICATION REFERENZEN FÜR DIE EINSTUFUNG RÉFÉRENCES POUR LE CLASEMENT	VALORI VALUES WERTE VALEURS
 REAZIONE AL FUOCO FIRE REACTION FEUERREAKTION RÉACTION AU FEU	EN 13823 EN 9239-1	CPR (UE) 305/2011, 2000/147/CE, UNI EN 13501-1	Classe A1_R Posa a pavimento Floor installation Bodeninstallation Pose au sol
			Classe A1 Posa a parete Wall installation Wandinstallation Pose au mur
 FLAME SPREAD	ASTM E84	-	Class A

CARATTERISTICHE TERMICHE_THERMAL FEATURES_THERMISCHE EIGENSCHAFTEN_CARACTÉRISTIQUES THERMIQUES

 CONDUCIBILITÀ TERMICA THERMAL CONDUCTIVITY WÄRMELEITFÄHIGKEIT CONDUCTIBILITÉ THERMIQUE	EN 12524	-	α = 1,3 W/m²K α = 0.7 Btu/ft h°F
--	----------	---	---

RIVESTIMENTO MONOPOROSA_SINGLE FIRED WALL TILES_GLASIERTES STEINGUT_REVÊTEMENT MONOCUISSON

REAZIONE AL FUOCO_FIRE REACTION_FEUERREAKTION_RÉACTION AU FEU



CARATTERISTICHE TECNICHE TECHNICAL FEATURES TECHNISCHE EIGENSCHAFTEN CARACTÉRISTIQUES TECHNIQUES	METODO DI PROVA TEST METHOD PRÜFMETHODE MÉTHODE D'ESSAI	RIFERIMENTI PER LA CLASSIFICAZIONE REFERENCES FOR THE CLASSIFICATION REFERENZEN FÜR DIE EINSTUFUNG RÉFÉRENCES POUR LE CLASEMENT	VALORI VALUES WERTE VALEURS
 REAZIONE AL FUOCO FIRE REACTION FEUERREAKTION RÉACTION AU FEU	EN 13823 EN 9239-1	CPR (UE) 305/2011, 2000/147/CE, UNI EN 13501-1	Classe A1_R Posa a pavimento Floor installation Bodeninstallation Pose au sol
			Classe A1 Posa a parete Wall installation Wandinstallation Pose au mur
 FLAME SPREAD	ASTM E84	-	Class A

CARATTERISTICHE TERMICHE_THERMAL FEATURES_THERMISCHE EIGENSCHAFTEN_CARACTÉRISTIQUES THERMIQUES

 CONDUCIBILITÀ TERMICA THERMAL CONDUCTIVITY WÄRMELEITFÄHIGKEIT CONDUCTIBILITÉ THERMIQUE	EN 12524	-	α = 0,7 W/m²K α = 0.4 Btu/ft h°F
--	----------	---	---

20 mm GRES PORCELLANATO_PORCELAIN TILES_FEINSTEINZEUG_GRÈS CÉRAME

REAZIONE AL FUOCO_FIRE REACTION_FEUERREAKTION_RÉACTION AU FEU

CARATTERISTICHE TECNICHE TECHNICAL FEATURES TECHNISCHE EIGENSCHAFTEN CARACTÉRISTIQUES TECHNIQUES	METODO DI PROVA TEST METHOD PRÜFMETHODE MÉTHODE D'ESSAI	RIFERIMENTI PER LA CLASSIFICAZIONE REFERENCES FOR THE CLASSIFICATION REFERENZEN FÜR DIE EINSTUFUNG RÉFÉRENCES POUR LE CLASEMENT	VALORI VALUES WERTE VALEURS
 REAZIONE AL FUOCO FIRE REACTION FEUERREAKTION RÉACTION AU FEU	EN 9239-1		Classe A1_R Posa a pavimento Floor installation Bodeninstallation Pose au sol
 FLAME SPREAD	ASTM E84		Class A

CARATTERISTICHE TERMICHE_THERMAL FEATURES_THERMISCHE EIGENSCHAFTEN_CARACTÉRISTIQUES THERMIQUES

 CONDUCIBILITÀ TERMICA THERMAL CONDUCTIVITY WÄRMELEITFÄHIGKEIT CONDUCTIBILITÉ THERMIQUE	EN 12524	-	α = 1,3 W/m²K α = 0.7 Btu/ft h°F
--	----------	---	---

Informazioni per la posa

Laying information_Informationen für die verlegung_Informations pour la pose

Suggerimenti per la posa

Laying suggestions_Conseils pour la pose_Empfehlungen für das verlegen

È compito del posatore controllare sempre il materiale prima della posa. Stendere a terra alcune piastrelle (circa 3 mq) e verificarne accuratamente le specifiche tecniche ed estetiche d'insieme.

The person in charge of installation must check all material before installing it. Place some tiles on the floor (approx. 3 m²) and check the overall technical and aesthetic characteristics with particular care.

POSA

Con collanti indicati per prodotti a bassa porosità.

Dopo aver effettuato la stuccatura, rimuovere in breve tempo con frequenti lavaggi di spugna ed acqua gli eccessi fino alla totale pulizia del pavimento. Successivamente fare lavaggio acido e alcalino come da istruzioni Panaria.

Per la realizzazione di tagli interni e a «L» si consiglia di arrotondare i vertici dell'apertura utilizzando punte con diametro di almeno 5 mm, per ridurre il rischio di rottura o fessurazioni, nel materiale già posato.

È consigliabile posare il gres porcellanato Panaria utilizzando livellatori meccanici. Va però evidenziato che in commercio sono disponibili molteplici modelli, alcuni dei quali per le loro modalità di utilizzo, possono risultare non indicati per prodotti ceramici con particolari finiture. In caso di necessità si prega di contattare il Technical Department Panariagroup prima dell'installazione.

Per le indicazioni di posa di ZERO.3 far riferimento al Manuale Tecnico ZERO.3.

SOTTOFONDO

Massetto cementizio.

DIMENSIONE FUGA

2 mm per i prodotti rettificati e 4 mm per i prodotti non rettificati. Salvo diversa indicazione dei Codici di Posa Nazionali. La larghezza delle fughe deve comunque essere decisa dalla Direzione Lavori.

COLORE FUGA

Grigio cemento o colore in tono con la piastrella.

Prima di usare stucchi colorati a grana fine su prodotti lappati, LEVIGATI O SPAZZOLATI, fare sempre un test di prova. Se il pigmento colorato è molto tenace la rimozione potrebbe risultare molto difficoltosa.

LAYING

With adhesives for products with a low porosity.

After grouting, remove any excess product as quickly as possible by repeatedly washing the area with a sponge and water. Then perform acid washing, as instructed by Panaria.

To create interior and "L" cuts it is advisable to round off the tops of the opening using drill bits with a diameter of at least 5 mm to reduce the risk of breakage or cracks in the already laid material.

It is advisable to lay Panaria porcelain stoneware using mechanical levellers. However, it should be noted that many models are available on the market, some of which, due to their operating methods, may not be suitable for ceramic products with particular finishes. If necessary, please contact the Panariagroup Technical Department before installation.

For instructions on laying ZERO.3, refer to the ZERO.3 Technical Manual.

SUBSTRATE

Compact cement bed.

JOINT WIDTH

2 mm for rectified tiles and 4 mm for not ground tiles. The width of grout joints must be established by the installation supervisor, unless grout widths are regulated by national laying standards.

GROUT COLOUR

Grey or matching the colour of the tile.

Before using fine-grain coloured grout on lapped, polished or brushed products, always perform a test. If the coloured pigment is very adhesive, it may be very difficult to remove.

Le poseur doit donc toujours contrôler le matériel avant la pose. Poser quelques carreaux (environ 3 m²) sur le sol sans les coller et en contrôler soigneusement les spécifications techniques et esthétiques générales.

Es ist Aufgabe des Fliesenlegers das Material vor der Verlegung stets zu kontrollieren. Einige Fliesen auf den Boden legen (circa 3 qm) und sorgfältig die spezifische ganzheitlichen Technik und Ästhetik überprüfen.

POSE

Avec des colles adaptées aux produits à faible porosité.

Après avoir effectué le stucage, éliminer rapidement les excès par des lavages fréquents avec une éponge et de l'eau jusqu'à ce que le sol soit complètement propre. Effectuer ensuite le lavage acide et alcalin selon les instructions fournies par Panaria. Sous-couche: lit de ciment compact. Pour réaliser des découpes internes en « L » nous conseillons d'arrondir les sommets de l'ouverture avec des forets de 5mm de diamètre minimum, afin de réduire le risque de rupture ou de fissure du matériau déjà en place.

Nous conseillons de poser le grès cérame Panaria en utilisant des niveleuses mécaniques. Nous faisons remarquer qu'il existe dans le commerce plusieurs modèles, dont certains peuvent, à cause de leur mode d'emploi, ne pas être indiqués pour les produits en céramique ayant des finitions particulières. En cas de besoin veuillez contacter le Service technique de Panariagroup avant de procéder à l'installation.

Pour les indications de pose de ZERO.3 consultez le Manuel technique de ZERO.3.

SOUS-COUCHE

Lit de ciment compact.

DIMENSION JOINT

2 mm pour les carreaux rectifiés et 4 mm pour les carreaux pas rectifiés. Sauf indication contraire contenue dans les Normes de Pose Nationaux, la dimension des joints doit en tous cas être définie par le directeur des travaux.

COULEUR JOINT

Ciment griso ou dans la teinte du carreau.

Toujours effectuer un test avant d'utiliser des stucs colorés à granulométrie fine sur des produits ponces, polis et brossés. L'élimination d'un pigment très prononcé pourrait s'avérer difficile.

VERLEGUNG

Mit klebern für produkte mit geringer porosität.

Nach vorgenommener spachtelung schnell mit häufigem reinigen mit schwamm und wasser das überschüssige material bis zur vollständigen reinigung des fußbodens entfernen. Anschließend saures und alkalines nachspülen vornehmen, gemäß den vorgaben von Panaria. Für Innen- und „L“-Schnitte empfehlen wir, die Kanten der Öffnung mit Aufsätzen mit mindestens 5 mm Durchmesser abzurunden, um das Risiko von Bruchstellen oder Rissen im bereits verlegten Material zu verhindern.

Feinsteinzeug von Panaria sollte mithilfe von mechanischen Richtmaschinen verlegt werden. Es ist jedoch zu beachten, dass auf dem Markt eine Vielzahl von Modellen erhältlich ist. Einige davon könnten aufgrund der Art und Weise, wie sie verwendet werden, für Keramikprodukte mit speziellem Finish nicht geeignet sein. Bei Bedarf bitte vor dem Verlegen mit der Technischen Abteilung von Panariagroup Rücksprache halten.

Für Anweisungen zum Verlegen von ZERO.3 bitte im Technischen Handbuch von ZERO.3 nachlesen.

UNTERGRUND

Kompakter Zementestrich.

FUGENBREITE

2 mm für geschliffene Platten und 4 mm für ungeschliffene Platten. Sofern in den Nationalen Verlegungsstandards nicht anders angegeben, ist die Breite der Fugen von der Bauleitung zu bestimmen.

FUGENFARBE

Grau oder auf die Fliesenfarbe abgestimmt.

Bevor farbige fugenfüller mit feiner körnung auf geläppten, gehonten und gebürsteten produkten eingesetzt werden ist stets eine probeanwendung erforderlich. Wenn das farbpigment sehr resistent ist, könnte der fugenfüller sehr schwer zu entfernen sein.



FUGA MINIMA CONSIGLIATA^(*)
RECOMMENDED MINIMUM JOINT^(*)
MINIMALE EMPFOHLENE FUGE^(*)
JOINT MINIMUM CONSEILLÉ^(*)

RECT (INTERNO / INDOOR / INNEN / INTÉRIEUR)

2 mm

NOT RECT (INTERNO / INDOOR / INNEN / INTÉRIEUR)

3-4 mm circa / approx. / z.ka / environs

ESTERNO / OUTDOOR / AUSSEN / EXTÉRIEUR

5-6 mm circa / approx. / z.ka / environs

() Salvo diversa indicazione dei Codici di Posa Nazionali. La larghezza delle fughe deve comunque essere decisa dalla Direzione Lavori.** The width of grout joints must be established by the installation supervisor, unless grout widths are regulated by national laying standards. Ausgenommen eigene gesetzlichen Verlege-Regelungen. Die Breite der Fuge muss von der Bauleitung entscheiden worden. Sauf indication différente du DTU. La dimension des joints doit être, de toute façon, décidé par le responsable du chantier.

Tabelle calibri

Size table_Formattabellen_Tableaux des calibres

FUGA MINIMA CONSIGLIATA 2 mm_RECOMMENDED MINIMUM JOINT 2 mm_MINIMALE EMPFOHLENE FUGE 2 mm_JOINT MINIMUM CONSEILLÉ 2 mm

CALIBRO CALIBRE KALIBER CALIBRE	30x30 RECT		40x60 RECT		30x60 RECT		60x60 RECT		40x120 RECT		60x120 RECT		20x120 RECT		30x120 RECT		45x45 RECT	
O	299,0	299,0	399,3	600,0	299,0	600,0	600,0	600,0	399,3	1202,0	600,0	1202,0	198,7	1202,0	299,0	1202,0	449,5	449,5
P	298,0	298,0	398,0	598,0	298,0	598,0	598,0	598,0	398,0	1198,0	598,0	1198,0	198,0	1198,0	298,0	1198,0	448,0	448,0
Q	297,0	297,0	396,7	596,0	297,0	596,0	596,0	596,0	396,7	1195,0	596,0	1195,0	197,0	1195,0	297,0	1195,0	446,5	446,5
R	296,0	296,0	395,3	595,0	296,0	595,0	595,0	595,0	395,3	1192,0	595,0	1192,0					445,0	445,0

CALIBRO CALIBRE KALIBER CALIBRE	37,5x75 RECT		75x75 RECT		15x90 RECT		30x90 RECT		45x90 RECT		60x90 RECT		90x90 RECT		20x180 RECT		30x180 RECT	
O	374,2	750,5	750,5	750,5	148,5	901,0	299,0	901,0	449,5	901,0	599,0	901,0	901,0	901,0	198,7	1803,0	298,0	1803,0
P	373,0	748,0	748,0	748,0	148,0	898,0	298,0	898,0	448,0	898,0	598,0	898,0	898,0	898,0	198,0	1799,0	297,0	1799,0
Q	371,7	745,5	745,5	745,5	147,5	895,0	297,0	895,0	446,5	895,0	596,0	895,0	895,0	895,0	197,0	1795,0	296,0	1795,0

CALIBRO CALIBRE KALIBER CALIBRE	44x88 RECT		88x88 RECT	
S	439,5	881,0	881,0	881,0
T	438,0	878,0	878,0	878,0
U	436,5	875,0	875,0	875,0

FUGA MINIMA CONSIGLIATA 3 mm_RECOMMENDED MINIMUM JOINT 3 mm_MINIMALE EMPFOHLENE FUGE 3 mm_JOINT MINIMUM CONSEILLÉ 3 mm

CALIBRO CALIBRE KALIBER CALIBRE	45,2x45,2 NAT	30x60,3 NAT	60,3x60,3 NAT
F	447,9x447,9	297,6x598,2	598,2x598,2
G	449,7x449,7	298,8x600,6	600,6x600,6
J	451,5x451,5	300,0x603,0	603,0x603,0
K	453,3x453,3	301,2x605,4	605,4x605,4
Y	455,1x455,1	302,4x607,8	607,8x607,8

FUGA MINIMA CONSIGLIATA 4 mm_RECOMMENDED MINIMUM JOINT 4 mm_MINIMALE EMPFOHLENE FUGE 4 mm_JOINT MINIMUM CONSEILLÉ 4 mm

CALIBRO CALIBRE KALIBER CALIBRE	20,0x90,5 NAT	20,0x121,5 NAT
M	198,0 x 899,0	198,0 x 1201,0
Q	198,4 x 900,8	198,4 x 1203,4
S	198,8 x 902,6	198,8 x 1205,8
T	199,2 x 904,4	199,2 x 1208,2
X	199,6 x 906,2	199,6 x 1210,6
U	200,0 x 908,0	200,0 x 1213,0
A	200,4x909,8	200,4 x 1215,4

FUGA MINIMA CONSIGLIATA 4 mm_RECOMMENDED MINIMUM JOINT 4 mm_MINIMALE EMPFOHLENE FUGE 4 mm_JOINT MINIMUM CONSEILLÉ 4 mm (Petra Solis)

CALIBRO CALIBRE KALIBER CALIBRE	20,0x20,0 NAT	20,0x40,4 NAT	40,4x40,4 NAT	40,4x60,8 NAT	60,8x60,8 NAT
I	197,6x197,6	197,6x399,2	399,2x399,2	399,2x600,8	600,8x600,8
Q	198,4x198,4	198,4x400,8	400,8x400,8	400,8x603,2	603,2x603,2
T	199,2x199,2	199,2x402,4	402,4x402,4	402,4x605,6	605,6x605,6
U	200,0x200,0	200,0x404,0	404,0x404,0	404,0x608,0	608,0x608,0
V	200,8x200,8	200,8x405,6	405,6x405,6	405,6x610,4	610,4x610,4

FUGA MINIMA CONSIGLIATA 10 mm_RECOMMENDED MINIMUM JOINT 10 mm_MINIMALE EMPFOHLENE FUGE 10 mm_JOINT MINIMUM CONSEILLÉ 10 mm (Bioarch e Pietre di Fanes)

CALIBRO CALIBRE KALIBER CALIBRE	20x20 NAT	20x30,5 NAT	20x41 NAT
B	197,6x197,6	197,6x301,4	197,6x405,2
E	200,0x200,0	200,0x305,0	200,0x410,0
M	202,4x202,4	202,4x308,6	202,4x414,8

Zero.3 SPESSORE 5,5 mm_THICKNESS 5,5 mm_STÄRKE 5,5 mm_EPAISSEUR 5,5 mm

CALIBRO CALIBRE KALIBER CALIBRE	20x100		20x150		20x200		20x120		20x180		33x300		33x100		50x100		100x100	
F	197	1000	197	1500	197	2000	197	1200	197	1800	330	3000	330	997	497	997	997	997

CALIBRO CALIBRE KALIBER CALIBRE	100x150		50x150		100x250		100x300	
F	997	1500	497	1500	997	2500	997	3000

Zero.3 SPESSORE 6 mm_THICKNESS 6 mm_STÄRKE 6 mm_EPAISSEUR 6 mm

CALIBRO CALIBRE KALIBER CALIBRE	20x120		30x240		40x120		60x60		60x120		120x120		120x240		120x250		120x260	
P	198	1198	298	2398	398	1198	598	598	598	1198	1198	1198	2398	1198	2500	1198	2600	

Pulizia

Cleaning_Reinigung_Nettoyage

Pulizia stucchi cementizi miscelati con acqua

Cleaning cement-based grouts mixed with water_Reinigung des mit wasser Angemischten zementmörtels
Nettoyage des enduits de ciments mélangés à de l'eau

PULIZIA "DOPOPOSA"

La pulizia "dopoposa" serve per rimuovere i residui di stucchi per le fughe, cemento, calce, boiaccia. È obbligatoria a fine cantiere, sia per le piastrelle smaltate che per quelle non smaltate. Effettuare la pulizia dopo 4-5 giorni dalla stuccatura (lo stucco deve indurire) e non oltre 10 giorni. Oltre questi tempi la pulizia può diventare molto più laboriosa.

Superfici antiscivolo

Per loro peculiarità, le superfici antiscivolo, ruvide o strutturate si puliscono più laboriosamente. Si consiglia perciò di prestare particolare attenzione alle modalità di pulizia, in particolare intervenendo rapidamente ed utilizzando monospazzola con dischi bianchi e beige.

CLEANING AFTER LAYING

Cleaning after laying is done to remove residues of joint fillers, cement, lime or grout. It is essential to do it at the end of the job, both for glazed and for unglazed tiles. Carry out cleaning 4-5 days after grouting (the grout needs to harden) and not later than 10 days after grouting. Any later than this, and cleaning can become very laborious.

Anti-slip surfaces

Due to their special features, rough or structured anti-slip surfaces are harder to clean. It is thus recommended to be very careful while cleaning, above all intervening quickly and using a single brush with white or beige disks.

REINIGUNG NACH DEM VERLEGEN

Die Reinigung nach dem Verlegen dient dazu, die Reste des Fugenmörtels, des Betons, des Kalks und der Zementmasse von den Fliesen zu entfernen. Die Reinigung muss sofort nach Beendigung der Arbeiten erfolgen. Dies gilt sowohl für glasierte als auch für unglasierte Fliesen. Die Fliesen 4-5 Tage, spätestens aber 10 Tage nach dem Verputzen reinigen (der Putz muss erhärten). Nach diesem Zeitraum kann die Reinigung einen sehr viel höheren Arbeitsaufwand erforderlich machen.

Rutschfeste oberflächen

Aufgrund ihrer Beschaffenheit sind die rutschfesten, rauhen oder strukturierten Oberflächen etwas schwieriger zu reinigen. Aus diesem Grunde ist die Reinigung sehr wichtig. Für eine schnellere Reinigung wird der Einsatz einer Einscheibenmaschine mit einer weissen oder beige Scheibe empfohlen.

NETTOYAGE APRÈS LA POSE

Le nettoyage après la pose permet de retirer les résidus de ciment, de jointoiement, de ciment, de plâtre et de coulis. Il est obligatoire en fin de chantier pour les carrelages émaillés ou non. Procéder au nettoyage 4 à 5 jours après le rejointoiement (le matériau doit durcir) et en tout cas avant 10 jours. Après ce délai, le nettoyage risque d'être beaucoup plus difficile.

Surfaces antidérapantes

Du fait de leurs caractéristiques spécifiques, les surfaces antidérapantes (rugueuses ou structurées) demandent des opérations de nettoyage plus complexes. Il est donc conseillé de suivre minutieusement les instructions de nettoyage, de veiller à réduire le plus possible les temps d'intervention et d'utiliser une monobrosse avec des disques blancs ou beiges.

TIPO DI DETERGENTE TYPE OF DETERGENT ART DES REINIGUNGSMITTELS TYPE DE DÉTERGENT	NOME DETERGENTI NAME OF DETERGENT NAME DES REINIGUNGSMITTELS NOM DU DÉTERGENT	PRODUTTORE MANUFACTURER HERSTELLER FABRICANT
A base acida Acid-based Auf säurebasis À base acide	SOLVACID (*) CEMENT REMOVER (*) DETERDEK (*) KERANET (*) TREK (*) ZEMENTSCHLEIERENTFERNER (*) HMK R63 (*) BONACLEAN / BCLEAN (*)	GEAL FABERCHIMICA FILA MAPEI KITER LITHOFIN HMK
	BONADECAN / BDECON (*) Specifico per prodotti non resistenti agli acidi Specific for products not resistant to acids Für nicht säurebeständige Produkte geeignet Spécifique pour produits pas résistant aux acides	BONASYSTEMS ITALIA

(*) Seguire attentamente le modalità d'uso indicate sulle confezioni dai fabbricanti. Fare sempre test preventivo sulle piastrelle prima dell'uso, in particolare su prodotti Lappati o Levigati.

(*) Follow the manufacturer's instruction closely. Always do a test in advance on the tiles before use, particularly on Lapped or polished products.

(*) Aufmerksam die Anweisungen der Hersteller befolgen. Vor der Benutzung sollten Sie immer erst einen prophylaktischen Probeauftrag durchführen, besonders auf geläpften oder polierten Fliesen.

(*) Suivre attentivement les indications des fabricants. Toujours procéder à un essai sur les carreaux avant l'utilisation, surtout pour les articles rodés ou polis.

Pulizia stucchi epossidici, bi-componenti e reattivi

Cleaning for epoxy, bi-component and reagent grouts_Reinigung von Epoxi-, bi-komponent und aktiven Spachtelmassen
Nettoyage des joints Epoxy, bi-composant et réactif

La rimozione di questi stucchi deve essere fatta immediatamente ed in modo accurato perché questi stucchi induriscono molto rapidamente, anche in pochi minuti.

Seguire attentamente le modalità di pulizia indicate dal fabbricante dello stucco utilizzato e verificarne l'efficacia (anche controllo) con una prova preliminare di pulizia prima di stuccare l'intero pavimento/parete.

Removal of the residues of these grouts must be carried out immediately and thoroughly, as these grouts harden very rapidly, even in a few minutes. Please carefully follow the cleaning mode specified by the manufacturer of the grout used; verify its effectiveness (backlight also) with a preliminary cleaning test before grouting the entire floor/wall.

Die Reste dieser Mörtelarten müssen sofort nach dem Verlegen sorgfältig entfernt werden, da sie extrem schnell (in wenigen Minuten) erhärten.

Die angegebene Reinigungshinweis vom Hersteller der verwendete Fugenmasse sorgfältig befolgen. Vor dem Verfugen des gesamten Belag (Boden u/o Wand), die Wirkung der Reinigungsempfehlung (auch im Gegenlicht) mit einem Vor-Test Reinigung überprüfen.

Le nettoyage des résidus doit être effectué immédiatement et avec soin, car ce type de matériau durcit très rapidement (en quelques minutes). Suivez attentivement les indications de nettoyage indiqué par le fabricant de joint utilisé et vérifiez son efficacité (même rétro-éclairage) avec un nettoyage préventif avant de jointoyer la totalité du sol/mur.

Protettivi per fughe

Stain resistant products for joints_Fugenschutzmittel_Protection joints

Servono per ridurre la porosità e quindi la macchiabilità delle fughe cementizie. L'applicazione di questi protettivi ne migliora anche la pulibilità.

Folgende Mitteln reduzieren die Porosität der Fugen und daher erhöhen die Fleckenbeständigkeit der Fugen. Die Anwendung dieser Schützmitteln verbessern auch die Reinigung.

In order to reduce absorption and stain. The application of these products improves cleaning as well.

Ils servent afin de réduire la porosité et donc la tachabilité des joints en ciment. L'application des ces produits améliore aussi l'entretien.

Seguire attentamente le modalità d'uso indicate sulle confezioni dai fabbricanti

Follow the manufacturer's instruction closely

Aufmerksam die Anweisungen der Hersteller befolgen

Suivre attentivement les indications des fabricants

NOME PRODOTTO NAME OF PRODUCT PRODUKTNAME NOM DU PRODUIT	PRODUTTORE MANUFACTURER HERSTELLER FABRICANT
FUGAPROOF	FILA
KF FUGENSCHUTZ	LITHOFIN

Pulizia

Cleaning_Reinigung_Nettoyage

Pulizia quotidiana

Routine cleaning_Tägliche Reinigung_Nettoyage quotidien

Utilizzare acqua calda e un panno in microfibra di buona qualità, tipo **MAGICCLEAN** di Bonasystem Italia. Ogni tanto, ad esempio ogni 10-20 giorni a seconda dello stato della pavimentazione, utilizzare detergenti neutri molto diluiti in acqua calda, che non contengono cere o non depositano patine lucide. A fine lavaggio risciacquare sempre con acqua calda, utilizzando un secondo panno in microfibra di buona qualità. Si consigliano i seguenti prodotti reperibili in commercio.

Use warm water and a good quality microfibre cloth, such as **MAGICCLEAN** by Bonasystems Italy. Every now and again, e.g. every 10-20 days depending on the state of the flooring, use neutral detergents very diluted with hot water, that are wax-free, and do not deposit glossy films. When the cleaning process is finished always rinse with hot water, using a second good quality microfibre cloth. We recommend the following products which are available on the market.

Warmes Wasser und ein hochwertiges Mikrofasertuch vom Typ **MAGICCLEAN** von Bonasystems Italia verwenden. Ab und zu, zum Beispiel alle 10-20 Tage, je nach Zustand des Fußbodenbelags, neutrale in warmen Wasser verdünnte Reinigungsmittel verwenden, die wachsfrei sind und keine glänzenden Schmierfilme hinterlassen. Nach dem Reinigen immer mit warmen Wasser nachspülen und dafür ein zweites hochwertiges Mikrofasertuch verwenden. Es wird empfohlen, folgende im Handel erhältlichen Produkte zu verwenden.

Utiliser de l'eau chaude et un chiffon en microfibre de bonne qualité, type **MAGICCLEAN** de Bonasystems Italia. De temps en temps, tous les 10-20 jours par ex., et selon l'état du sol, utiliser des détergents neutres très dilués dans de l'eau chaude qui ne contiennent pas de cires et ne laissent pas de tâches brillantes. En fin de lavage, rincer toujours à l'eau chaude et à l'aide d'un chiffon en microfibre de bonne qualité. Ces produits sont disponibles dans le commerce.

TIPO DI DETERGENTE TYPE OF DETERGENT ART DES REINIGUNGSMITTELS TYPE DE DÉTERGENT	NOME DETERGENTI NAME OF DETERGENT NAME DES REINIGUNGSMITTELS NOM DU DÉTERGENT	PRODUTTORE MANUFACTURER HERSTELLER FABRICANT	TIPO DI MICROFIBRA TYPE OF MICRO-FIBER ART DER MICRO-FASER TYPE DE MICROFIBRA
Neutro Neutral Neutral Reiniger Neutre	FLOOR CLEANER	FABERCHIMICA	MAGICCLEAN / BMAGICCLEAN (BONASYSTEMS ITALIA)
	FILA CLEANER	FILA	o similari
	BELGRES	GEAL	or like products
	BONAMAIN + / BMAIN +	BONASYSTEMS ITALIA	ou produits similaires
	BONATITANIA CLEAN / BTITANIA CLEAN	BONASYSTEMS ITALIA	oder ähnliche Produkte
	PFLEGEREINIGER	LITHOFIN	
	HMK P15	HMK	

Pulizia straordinaria

Non-routine cleaning_Außerplanmäßige Reinigung_Nettoyage extraordinaire

TIPO DI SPORCO TYPE OF DIRT SCHMUTZART TYPE DE SALETÉ	TIPO DI DETERGENTE TYPE OF DETERGENT ART DES REINIGUNGSMITTELS TYPE DE DÉTERGENT	NOME DETERGENTI NAME OF DETERGENT NAME DES REINIGUNGSMITTELS NOM DU DÉTERGENT	PRODUTTORE MANUFACTURER HERSTELLER FABRICANT
Caffè, coca cola, succhi di frutta Coffee, coca-cola, fruit juice Kaffee, coca cola, fruchtsäfte Café, coca-cola, jus de fruits	POLIFUNZIONALI, A BASE ALCALINA ⁽¹⁾ Multipurpose, alkaline based ⁽¹⁾ Polyfunktionell, mit alkalibasis ⁽¹⁾ Alcalins universels ⁽¹⁾	COLOURED STAIN REMOVER PS87 SUPER DETERJET CANDEGGINA Bleach Bleichmittel Eau de Javel	FABERCHIMICA FILA GEAL VARI PRODUTTORI Various manufactures Verschiedene hersteller Fabricants divers
Grassi, polvere da calpestio, pulizie di fondo Grease, dust footmarks, base cleaning Fette, trittstaub, grundreinigung Graises, dépôts de poussières, grands nettoyages	POLIFUNZIONALI, A BASE ALCALINA ⁽¹⁾ Multipurpose, alkaline based ⁽¹⁾ Polyfunktionell, mit alkalibasis ⁽¹⁾ Alcalins universels ⁽¹⁾	PS87 DETERFLASH INTENSIVREINIGER HMK R55 TASKI R20-STRIP BONADECOR / BDECOR	FILA GEAL LITHOFIN HMK JOHNSONDIVERSEY BONASYSTEMS ITALIA
Vino Wine Wein Vin	OSSIDANTE Oxidising Oxidationsmittel Oxydant	OXIDANT CANDEGGINA Bleach Bleichmittel Eau de Javel	FABERCHIMICA VARI PRODUTTORI Various manufactures Verschiedene hersteller Fabricants divers
Depositii calcare Deposits of lime Kalkablagerungen Dépôts de calcaire	A BASE ACIDA ⁽¹⁾ Acid-based ⁽¹⁾ Auf säurebasis ⁽¹⁾ À base acide ⁽¹⁾	VIKAL	PROCTER & GAMBLE
Ruggine Rust Rost Rouille	A BASE ACIDA ⁽¹⁾ Acid-based ⁽¹⁾ Auf säurebasis ⁽¹⁾ À base acide ⁽¹⁾	ACIDO MURIATICO DILUITO Dilute hydrochloric acid Verdünnte salzsäure Acide muriatique dilué	VARI PRODUTTORI Various manufactures Fabricants divers Verschiedene hersteller
Pneumatici, segni di matita, segni metallici Tyre marks, pencil marks, metallic marks Reifenschmutz, bleistift- und metallische rückstände Pneumatiques, traces de crayon, traces métalliques	PASTA ABRASIVA ⁽¹⁾ Abrasive paste ⁽¹⁾ Scheuermittel ⁽¹⁾ Pâte abrasive ⁽¹⁾	POLISHING CREAM ⁽²⁾ DETERGUM ⁽²⁾ VIM CLOREX ⁽²⁾ STRONG REMOVER ⁽²⁾	FABERCHIMICA ZEP ITALIA GUABER FABERCHIMICA
Inchiostri, pennarello Ink, marker pens Tinte, filzstift Encres, marqueurs	A BASE SOLVENTE Solvent-based Auf lösungsmittelbasis À base de solvant	DILUENTE NITRO, ACQUA RAGIA Nitrous thinners, white spirit Nitroverdünnungsmittel, acqua ragia Diluant nitrocellulosique, white spirit COLOURED STAIN REMOVER	VARI PRODUTTORI Various manufactures Fabricants divers Verschiedene hersteller FABERCHIMICA
Sporco sulle fughe Tile joint stains Fugenschmutz Saleté des joints	SPECIFICO Specific Spezifisch Spécifique	FUGANET FUGENREINIGER	FILA LITHOFIN

Modalità d'uso: seguire le indicazioni dei fabbricanti _Method of use: follow the manufacturer's instructions_ _Gebrauchsanleitung: Die Angaben der Hersteller befolgen_ _Mode d'emploi: suivre attentivement les indications des fabricants

(1) Fare sempre test preventivo su materiali Lappati e Levigati _Always do a test in advance on lapped or polished tiles_ _Von der Benutzung immer erst einen Probeauftrag durchführen, besonders auf geläpften u. polierten Fliesen_ _Toujours procéder à un essai sur les carreaux rodés ou polis

(2) Usare con molta attenzione sui materiali Lappati e Levigati _Exercise extreme caution when using on Lapped and polished materials_ _Auf geläpftem und poliertem Material mit besonderer Vorsicht verwenden_ _Utiliser avec précaution sur les matériaux Polis et Rodés

(3) Non usare su prodotti Lappati, usare con molta attenzione sui Levigati _Do not use on lapped products, and use with great care on polished products_ _Nicht zum Reinigen geläpfter Produkte und nur sehr vorsichtig bei geschliffenen Oberflächen benutzen_ _Ne pas utiliser sur des articles Rodés, utiliser avec prodence sur les articles Polis

NON utilizzare cere su piastrelle Panaria.

KEINE Wachse auf Fliesen von Panaria verwenden.

DON'T USE wax on Panaria tiles.

NE UTILISER PAS des cires sur les carreaux Panaria.

Pulizia

Cleaning_Reinigung_Nettoyage

Rimozione di cere o patine lucidanti

Removing waxes or glossy coatings_Das Entfernen von Wac s und glänzender Patina_Retrait de cire ou de patine brillante

Non seguire le indicazioni sulla confezione, ma applicare il detergente puro, lasciare agire per 5-10 minuti, frizionare con tamponi morbidi (bianco, giallo) e sciacquare bene con acqua.

In diesem Fall dürfen die Anweisungen auf der Verpackung NICHT befolgt werden. Der Reiniger muss unverdünnt aufgetragen werden und 5-10 Minuten lang einwirken. Danach mit einem weichen Pad einreiben (weiß, gelb) und gründlich mit Wasser abspülen.

Do not follow the instructions on the packaging, but apply the detergent neat, leave to act for 5-10 minutes, rub with a soft pad (white, yellow) and rinse well with water.

Ne pas suivre les indications figurant sur l'emballage. Appliquer le détergent pur. Laisser agir pendant 5 à 10 minutes. Frotter à l'aide d'un chiffon doux (blanc, jaune) et bien rincer à l'eau claire.

TIPO DI DETERGENTE TYPE OF DETERGENT ART DES REINIGUNGSMITTELS TYPE DE DÉTERGENT	NOME DETERGENTI NAME OF DETERGENT NAME DES REINIGUNGSMITTELS NOM DU DÉTERGENT	PRODUTTORE MANUFACTURER HERSTELLER FABRICANT
Specifico Specific Spezifisch Spécifique	TILE CLEANER (*) Puro Neat Puro Pur	FABERCHIMICA

* Prima della pulizia fare sempre test preventivo_Before cleaning always do a test in advance_Vor dem Reinigungsverfahren, Probetest vorführen_Avant le nettoyage procéder toujours à un essai sur les carreaux

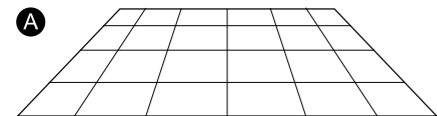

Pavimento originale.
Original floor
Originalfußboden
Sol originel

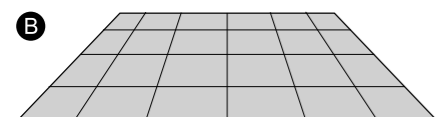

Dopo pulizia con detersivi che depositano patine lucide o dopo stuccatura con alcuni stucchi per le fughe.
After cleaning using detergents which leave a glossy finish, or after applying some products for joints.
Nach der Verwendung von Reinigungsmitteln, die einen glänzenden Film hinterlassen, bzw. nach dem Verfugen mit einigen Fugmassen.
Après nettoyage avec des détergents qui laissent une couche brillante ou après cimentage avec certains coulis pour joints.

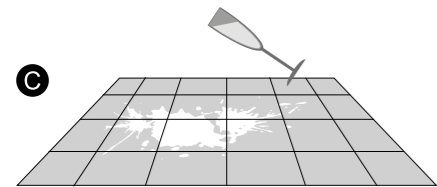

Semplici alimenti (Coca-Cola, vino, acqua...) possono togliere la patina lucida. La superficie originale è più opaca.
Simple foodstuffs (coca-cola, wine, water etc.) can remove the bright patina. The original surface is more matt.
Normale Lebensmittel (Coca-Cola, Wein, Wasser usw...) können die glänzende Patina entfernen. Die Originaloberfläche ist matter.
Certains aliments (Coca-Cola, vin, eau, etc.) peuvent enlever la patine brillante. La surface originelle est plus opaque.

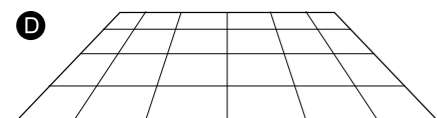

Rimuovere la patina con detergente idoneo con panno in microfibra ed effettuare la pulizia quotidiana come indicato in questa brochure nell'apposita sezione.
Remove the patina with a suitable detergent using a micro-fiber cloth, and carry out the everyday cleaning as per the indications in the appropriate section of this brochure.
Die Patina sollte mit geeigneten Reinigungsmittel entfernt werden mit einem Tuch aus Micro-Faser und die tägliche Reinigung sollte, verwendet werden wie in der passenden Abschnitt dieser Brochüre empfehit.
Retirer la patine à l'aide d'un détergent approprié avec une serpillière en microfibre et effectuer le nettoyage quotidien comme indiqué dans la section appropriée de cette brochure.

Pulizia dei decori

Cleaning decorations_Reinigung des Fliesendekors_Nettoyage décors

Utilizzare detersivi neutri e diluiti. NON UTILIZZARE detersivi acidi, alcalini, ceranti e/o impregnanti, abrasivi o pagliette abrasive o di metallo.

Verwenden Sie ausschließlich neutral und verdünnte Reinigungsmittel. VERWENDEN SIE AUF KEINEN FALL: Ätzende oder alkalische Reinigungsmittel, Scheuerpasten und Pulver, Grobe Bürsten oder abrasive Schwämme.

Use neutral and diluted detergents. NEVER USE acid or alkaline detergents, abrasive pastes, abrasive brushes or sponges.

Utiliser des détergents neutres et dilués. NE SURTOUT PAS utiliser des détergents acides ou alcalins, des produits abrasifs, des brosses ou des éponges abrasives.

Zero.3

Pulizia dei decori stampati

Cleaning printed decors_Reinigung der gedruckten Dekore_Nettoyage décors imprimés

PULIZIA DOPOPOSA

La pulizia dopoposa deve essere effettuata immediatamente quando lo stucco è ancora fresco. Nel caso vengano impiegati stucchi epossidici o bicomponenti in genere, utilizzare solo acqua, detergente neutro e panno o spugna morbida. Non usare assolutamente pulitori o solventi specifici per questi tipi di stucchi e neppure agenti abrasivi.

REINIGUNG NACH DEM VERLEGEN

Die Grundreinigung muss sofort getan werden, wenn der Fugenmörtel noch frisch ist. Beim Einsatz von Zweikomponenten- und Epoxidfuge ist nur Wasser, milde Reinigungsmittel und ein weiches Tuch oder Schwamm zu verwenden. Achtung: spezifische harte bzw. aggressive Reinigungs- oder Lösungsmittel als auch Schleifmittel sind nicht zu verwenden.

PULIZIA QUOTIDIANA

Utilizzare solo acqua, detergente neutro e panno o spugna morbida.

TÄGLICHE REINIGUNG

Bitte milde Reinigungsmittel mit weichem Tuch oder Schwamm verwenden Achtung: spezifische harte bzw. aggressive Reinigungs- oder Lösungsmittel als auch Schleifmittel sind nicht zu verwenden, benutzen sie bitte keinen Alkohol, keine Säuren, keine Scheuerschwämme, sondern nur neutrale Seifen.

Non usare mai pulitori per stucchi epossidici o bicomponenti, alcool,acidi,solventi,detergentiabrasivi,spugneruvide,pagliette metalliche o altri prodotti aggressivi.

CLEANING AFTER LAYING

The after-laying cleaning must be done immediately, when the grout is still wet. Should epoxy or bi-component grouts be used, use water only, mild detergent and soft cloth or sponge. Never use specific cleaners or solvents for these types of grouts or even abrasive agent.

NETTOYAGE APRÉS LA POSE

Le nettoyage après la pose doit être fait immédiatement lorsque le joint est encore frais. Dans le cas où des joints Epoxy ou des joints bi-composants en général sont utilisé, nettoyer avec de l'eau seulement, un détergent doux et un chiffon doux ou une éponge. N'utilisez ni des nettoyeurs ou de solvants pour ces types de joint ni des agents abrasifs.

ROUTINE CLEANING

Use only water, neutral soap and soft cloth or sponge. Do not use detergents for epoxy or bi-component grouts, alcohol, solvent, acid or abrasive products like brushes or sponges etc.

NETTOYAGE QUOTIDIEN

Nettoyer avec de l'eau pure, un détergent doux et un chiffon doux ou une éponge. Jamais utiliser des nettoyeurs pour joints époxy ou bi-composants, d'alcool, d'acides, de solvants, de détergents, des brosses ou d'éponges abrasives.

Pulizia

Cleaning_Reinigung_Nettoyage

Trattamenti Antislip

Anti-slip treatments_Anti-Rutsch-Behandlung_Traitement antidérapant

La resistenza allo scivolamento dei pavimenti posati (sia piastrelle smaltate che non smaltate) può essere aumentata utilizzando specifici prodotti (vedi tabella).

Prima di applicare il prodotto sul pavimento fare test preventivi su piastrelle non posate per trovare i tempi di contatto più idonei. Se da un lato tempi più lunghi aumentano il grado di grip, dall'altro tendono un po' a sbiancare i colori delle piastrelle e a renderle un pochino più sporcabili. Trattandosi di una applicazione molto tecnica, prima di eseguire qualsiasi prova contattare la ditta Bonasystems Italia.

The resistance of laid floor-tiles (both glazed and unglazed) to slipping can be increased by using specific products: see table.

Before applying the product to the floor, do an advance test on unglazed tiles to find the most suitable contact times. On the one hand, longer contact times increase the level of grip, but on the other hand they tend to whiten the colours of the tiles and make them attract dirt a little more. Before doing any test please contact Bonasystems Italia company, since this is a very technical application.

NOME PRODOTTO NAME OF PRODUCT PRODUKTNAME NOM DU PRODUIT	PRODUTTORE MANUFACTURER HERSTELLER FABRICANT
BONAGRIP	BONASYSTEMS ITALIA

RIFERIMENTI UTILI USEFUL REFERENCES NÜTZLICHE LINKS RÉFÉRENCES UTILES

MAPEI SpA via Cafiero 2 20158 Milano – ITALY Tel. +39 02 37673 www.mapei.it	JOHNSONDIVERSEY via Meucci, 40 20128 Milano Tel. +39 0373 2051 www.johnsondiversey.com	LITHOFIN-Producte GmbH, Postfach 1134, D-73236 Wendlingen (D) Service – Tel. 0049 07024/940320 www.lithofin.de Vertrieb für Österreich: CT-Austria Ges.m.b.H. A-1230 Wien Tel. 0043 01 8673434
FABERCHIMICA Srl via G. Ceresani 10 Loc. Campo d'Olmo - 60044 Fabriano (AN) - ITALY Tel. +39 0732 627178 www.faberchimica.com	BONASYSTEMS ITALIA SRL via Borgo S.Chicara, 29 30020 Torre di Mosto (VE) - ITALY Tel. +39 0421 325691, Fax +39 0421 324232 www.bonasystemsitalia.it	HMK - MÖLLER-CHEMIE Benelux GmbH Linge 4 NL-2105 WB Heemstede (NL) Tel. 0031 0252-220222 www.moellerchemie.de
FILA Industria Chimica SpA via Garibaldi 32 35018 S. Martino dei Lupari (PD) - ITALY Tel. +39 049 9467300 www.filachim.it	KITER Srl via Assiano 7/B 20019 Settimo Milanese (MI) – ITALY Tel. +39 030 3285220 www.kiter.it	FEDERCHEMICALS Srl Via G. Borsi, 2 25128 - Brescia - Italy Tel. +39 030 3390880, Fax +39 030 3385580 www.federchemicals.it
ZEP Italia Srl via Nettunese Km 25,000 04011 Aprilia (LT) – ITALY Tel. +39 06 926691 www.zepitalia.it	GEAL Srl via Settola 121 51031 Agliana (PT) – ITALY Tel. +39 0574 750365 www.geal-gres.it	

Panaria e l'ambiente

Panaria and the environment_Panaria und die Umwelt_Panaria et l'environnement

Zero.3

Materiale ideale per edifici a basso consumo energetico

Ideal for the construction of low-energy buildings_Ideales Material für Niedrigenergiehäuser

Matériau idéal pour édifices à faible consommation énergétique

Zero.3 è ideale per la costruzione di edifici a bassissimo consumo energetico; queste sono le applicazioni nelle quali ZERO.3 è il materiale ottimale:

- FINITURA DI PAVIMENTI E RIVESTIMENTI**
Zero.3 è un prodotto realizzato con materie prime naturali che non contengono sostanze sintetiche, che offre prestazioni di sicurezza (resistenza al fuoco), pulibilità e durabilità decisamente superiori rispetto al legno e alla moquette.
- IMPIANTI DI RISCALDAMENTO A PAVIMENTO**
Zero.3 offre prestazioni di eccellenza poiché favorisce l'ottimizzazione del sistema completo con temperature più basse dell'acqua e di conseguenza il risparmio energetico dell'intero impianto (grazie al suo basso spessore e alla conducibilità termica superiore rispetto al legno che è materiale isolante).
- FINITURE SUPERFICIALI DI RIVESTIMENTI A CAPPOTTO E FACCIATE VENTILATE**
L'utilizzo di Zero.3 è indicato per la sua leggerezza, il grande formato e la facilità di installazione. Inoltre, rispetto a materiali lapidei o metallici e rispetto alle finiture ad intonaco, Zero.3 offre sicuramente una maggiore resistenza agli agenti atmosferici, allo smog, agli agenti chimici, alle macchie e ai graffiti, e caratteristiche di eccellenza per quanto riguarda la durabilità nel tempo (resistenza all'invecchiamento, all'azione della luce e del gelo).
- FINITURA DI PANNELLI DI TAMPONAMENTO ESTERNO PER STRUTTURE E CASE PREFABBRICATE**
Zero.3 è la soluzione ottimale grazie alle sue caratteristiche tecniche, alla sua leggerezza e al grande formato.

Zero.3 is ideal for the construction of low energy consumption buildings and these are the applications in which ZERO.3 is the optimal material:

- FLOOR AND WALL COVERINGS**
Zero.3 is manufactured with raw materials that do not contain any synthetic substances and therefore offers the security of fire resistance, durability and easy cleaning superior to that of wood and carpet.
- FLOOR HEATING SYSTEMS**
Zero.3 assists with the optimization of the complete system by requiring lower water temperatures and consequently saving energy. This is due to its thickness and thermal conductivity which render it superior to moquette and wood.
- SUPERFICIAL SURFACES OF THERMAL INSULATION SYSTEM AND VENTILATED FACADES**
Zero.3 is recommended for its lightness, large size and easy installation. Moreover, when compared to stone, metallic or plaster materials Zero.3 offers a noticeably higher resistance to atmospheric agents, pollution, chemical agents, stains and graffiti, along with excellent durability (resistance to aging and the effects of light and frost).
- FINISH OF EXTERNAL WALLS PLUGS FOR STRUCTURES AND PREFABRICATE BUILDINGS**
Zero.3 is the perfect solution thanks to its technical characteristics, lightness and large sizes.

Zero.3 ist ideal für den Bau von Gebäuden mit sehr niedrigem Energieverbrauch; dies sind die Anwendungen, in denen ZERO.3 das optimale Material ist:

- ENDBEARBEITUNG VON BÖDEN UND WÄNDEN**
Zero.3 ist ein Produkt aus natürlichen Rohstoffen, die keine synthetischen Substanzen enthalten, das eine Sicherheitsleistung (Brandschutz), Reinigungsfähigkeit und Haltbarkeit bietet, die Holz und Teppichen weit überlegen ist.
- FUSSBODENHEIZUNGSSYSTEME**
Zero.3 bietet eine ausgezeichnete Leistungen, da es die Optimierung des Gesamtsystems mit niedrigeren Wassertemperaturen und damit die Energieeinsparung des Gesamtsystems begünstigt (dank seiner geringen Stärke und höheren Wärmeleitfähigkeit im Vergleich zu Holz, das ein Dämmstoff ist).
- OBERFLÄCHENVEREDELUNG VON AUSSENVERKLEIDUNGEN UND HINTERLÜFTETEN FASSADEN**
Die Verwendung von Zero.3 ist wegen seiner Leichtigkeit, Größe und einfachen Installation angezeigt. Darüber hinaus bietet Zero.3 im Vergleich zu Stein- oder Metallmaterialien und Putzoberflächen eine höhere Beständigkeit gegen Witterungseinflüsse, Smog, Chemikalien, Flecken und Graffiti, und hat hervorragende Eigenschaften in Bezug auf die Langlebigkeit (Alterungsbeständigkeit, Licht- und Frosteinwirkung).
- VEREDELUNG VON AUSSENVERKLEIDUNGSPLETTEN FÜR BAUWERKE UND FERTIGHÄUSER**
Zero.3 ist aufgrund seiner technischen Eigenschaften, seiner Leichtigkeit und seines großen Formats die optimale Lösung.

Zero.3 est idéal pour la construction d'édifices à très faible consommation énergétique ; celles-ci sont les applications dans lesquelles ZERO.3 est le matériau optimal :

- FINITION DE SOLS ET REVÊTEMENTS**
Zero.3 est un produit réalisé avec des matières premières naturelles qui ne contiennent pas de substances synthétiques, qui offre des prestations de sécurité (résistance au feu), nettoyabilité et durabilité nettement supérieures par rapport au bois et à la moquette.
- INSTALLATIONS DE CHAUFFAGE AU SOL**
Zero.3 offre des prestations d'excellence car il favorise l'optimisation du système complet avec des températures plus basses que l'eau et, par conséquent, l'économie d'énergie de toute l'installation (grâce à sa faible épaisseur et à la conductivité thermique supérieure par rapport au bois qui est un matériau isolant).
- FINITIONS DE SURFACE DE REVÊTEMENTS AVEC MURS MANTEAU ET FAÇADES VENTILÉES**
L'utilisation de Zero.3 est indiqué pour sa légèreté, le grand format et la facilité d'installation. De plus, par rapport aux matériaux en pierre ou métalliques et par rapport aux finitions à enduit, Zero.3 offre sûrement une plus grande résistance aux agents atmosphériques, à la pollution, aux agents chimiques, aux taches et aux graffitis, et des caractéristiques d'excellence en ce qui concerne la durabilité dans le temps (résistance au vieillissement, à l'action de la lumière et du gel).
- FINITION DE PANNEAUX DE TAMPONNEMENT EXTÉRIEUR POUR STRUCTURES ET MAISONS PRÉFABRIQUÉES**
Zero.3 est la solution optimale grâce à ses caractéristiques techniques, sa légèreté et son grand format.

Panaria e l'ambiente

Panaria and the environment_Panaria und die Umwelt_Panaria et l'environnement

Zero.3

L'impegno per la salvaguardia dell'ambiente

The commitment to protecting the environment_Engagement Für Umweltschutz_Engagement à préserver l'environnement



SALVAGUARDIA DELLE RISORSE NATURALI

- Riduzione del consumo delle materie prime del 70%.
- Riduzione del consumo di acqua del 70%.
- Riutilizzo del 100% degli scarti crudi (nel ciclo produttivo) e degli scarti cotti (come sottofondi di strade ed edifici).
- Riutilizzo del 100% delle acque di processo.

PROTECTION OF NATURAL RESOURCES

- 70% reduction of raw material consumption.
- 70% reduction of water consumption.
- 100% recycling of raw wastes (in production cycle) and fired wastes (used in road bases and buildings).
- 100% recycling of water used in production process.

SCHUTZ DER NATÜRLICHEN RESSOURCEN

- Reduzierung des Rohstoffverbrauchs um 70%.
- Reduzierung des Wasserverbrauchs um 70%.
- Wiederverwendung von 100% Rohabfällen (im Produktionszyklus) und gebrannten Abfällen (als Untergrund von Straßen und Gebäuden).
- 100%ige Wiederverwendung von Prozesswasser.

SAUVEGARDE DES RESSOURCES NATURELLES

- Réduction de la consommation des matières premières de 70 %.
- Réduction de la consommation d'eau de 70 %.
- Réutilisation de 100 % des déchets crus (dans le cycle de production) et des déchets cuits (comme les soubassements de routes et de bâtiments).
- Réutilisation de 100 % des eaux de traitement



DIMINUZIONE EMISSIONI IN ATMOSFERA

- Riduzione delle emissioni nell'aria di CO₂ grazie all'uso di tecnologie all'avanguardia e di soluzioni impiantistiche ottimali.
- Riduzione delle emissioni nell'aria di sostanze inquinanti.

REDUCTION OF EMISSIONS

- Reduction of CO₂ emissions thanks to the use of updated technologies.
- Reduced production of air pollutants.

REDUZIERUNG DER EMISSIONEN IN DIE ATMOSPHERE

- Reduzierung der CO₂-Emissionen in die Luft durch den Einsatz modernster Technologien und optimaler Anlagenlösungen.
- Reduzierung der Schadstoffemissionen in die Luft

DIMINUTION DES ÉMISSIONS DANS L'ATMOSPHERE

- Réduction des émissions dans l'air de CO₂ grâce à l'utilisation de technologies de pointe et de solutions d'installations optimales.
- Réduction des émissions dans l'air de substances polluantes.



TRASPORTI E IMBALLAGGI

- Possibilità di movimentare maggiori quantità di materiale per singolo viaggio, con conseguente riduzione dell'inquinamento derivante dai trasporti.
- Utilizzo di imballaggi 100% riciclabili.
- Utilizzo di pallett FAO, senza corteccia (DB) e conformi allo standard IPPC/FAO ISPM 15, offrendo quindi ai Paesi importatori ogni garanzia per la salvaguardia del proprio patrimonio forestale.

TRANSPORTATION AND PACKAGING

- Reduction of transport derived pollutants by moving larger quantities per trip.
- Use of 100% recyclable packaging material.
- Guaranteed protection of forests through use of FAO pallets, without cortex (DB) and following the IPPC/FAO ISPM 15 standard when exporting.

TRANSPORT UND VERPACKUNG

- Möglichkeit, größere Materialmengen pro Fahrt zu bewältigen, mit der Folge, dass die durch den Transport verursachte Umweltbelastung reduziert wird.
- Verwendung von 100% recycelbaren Verpackungen.
- Verwendung von FAO-Paletten, ohne Rinde (DB) und konform mit der Norm IPPC/FAO ISPM 15, wodurch den Importländern jede Garantie für den Schutz ihres Waldbestandes geboten wird.

TRANSPORTS ET EMBALLAGES

- Possibilité de déplacer de plus grandes quantités de matériaux à chaque voyage avec comme conséquence, une réduction de la pollution dérivant des transports.
- Utilisation d'emballages 100 % recyclables.
- Utilisation de palettes FAO, dépourvues d'écorce (DB) et conformes à la norme IPPC/FAO ISPM 15, offrant donc aux pays importateurs toute garantie pour la sauvegarde de leur propre patrimoine forestier.



OTTIMIZZAZIONE PRODUZIONE SCARTI E RIFIUTI

- Riduzione della produzione di scarti crudi e scarti cotti del 50%.
- Riduzione della produzione delle acque di processo derivanti dalla produzione delle lastre.

OPTIMIZATION OF WASTE MANAGEMENT

- 50% Reduction in raw and fired waste in production cycle
- Reduction of water use in the production of slabs.

OPTIMIERUNG DER ABFALLPRODUKTION

- Reduzierung der Produktion von Rohstoff- und Brandabfällen um 50%.
- Reduzierung der Produktion von Prozesswasser aus der Plattenproduktion.

OPTIMISATION PRODUCTION DÉCHETS ET REJETS

- Réduction de la production de déchets crus et déchets cuits de 50 %.
- Réduction des besoins en eau pour la production des dalles.



OTTIMIZZAZIONE PERFORMANCE ENERGETICHE

- Riduzione del consumo gas naturale del 50%.
- Uso di tecnologie all'avanguardia e di soluzioni impiantistiche ottimali.

OPTIMIZATION OF ENERGY PERFORMANCE

- 50% reduction of natural gas consumption.
- Continual implementation of up-to-date technology and innovative production processes.

OPTIMIERUNG DER ENERGIEEFFIZIENZ

- Reduzierung des Erdgasverbrauchs um 50%.
- Einsatz modernster Technik und optimaler Anlagenlösungen.

OPTIMISATION DES PERFORMANCES ÉNERGÉTIQUES

- Réduction de la consommation de gaz naturel de 50 %.
- Utilisation de technologies et de système de production de pointe.



CERTIFICAZIONI AMBIENTALI ISO 14001, EMAS ED EPD

Gli stabilimenti produttivi Panaria possiedono Sistemi di Gestione Ambientale certificati ISO 14001 ed EMAS (Regolamento CE N. 1221/2009). I prodotti Panaria possiedono la certificazione EPD specifica di Tipo III, certificata da Ente indipendente di terza parte secondo EN 15804 ed EN 14025.

ISO 14001, EMAS AND EPD ENVIRONMENTAL CERTIFICATIONS

Panaria tiles are produced in manufacturing plants with environmental management systems compliant to ISO 14001 and EMAS (EC Regulation 1221/2009).

Panaria products have a type III specific EPD. This is certified by an independent third party according to EN 14025 and EN 15804 standards.

UMWELTZERTIFIKATE ISO 14001, EMAS ED EPD

Die Panaria Produktionsanlage besitzen die Umweltzertifizierung ISO 14001 und EMAS (Regelung CE N. 1221/2009).

Die Produkte von Panaria und Fiorio besitzen die Zertifizierung EPD spezifisch von Typ III, von unabhängigen und fremden Anstalt gemäß EN 15804 und EN 14025 zertifiziert.

CERTIFICATIONS ENVIRONNEMENTALES ISO 14001, EMAS ET EPD

Les sites productif Panaria sont équipés de Système de Gestion Environnementale certifié ISO 14001 et EMAS (Règlement CE N. 1221/2009).

Les produits Panaria sont certifiés EPD spécifique de Type III, la certification est effectuée par un organisme indépendant tiers comme prévu par EN 15804 et EN 14025.



Panaria e l'ambiente

Panaria and the environment_Panaria und die Umwelt_Panaria et l'environnement



L'impegno per la salvaguardia dell'ambiente

The commitment to protecting the environment_Engagement Für Umweltschutz_Engagement à préserver l'environnement



RIUTILIZZO DEL 100% DEGLI SCARTI CRUDI

Il 100% degli scarti crudi sono riutilizzati nel ciclo produttivo, riducendo così l'estrazione di materie prime da cava e contribuendo in modo sensibile alla salvaguardia delle risorse naturali.

100% REUSE OF UNFIRED TILES

Crude waste generated by the process is reintegrated in the production cycle with no costs for the environment. This contributes to the safeguard of natural resources.

WIEDERVERWERTUNG VON 100% DER ROHABFÄLLE

100% der Rohabfälle werden im Produktionszyklus wiederverwendet, die Entnahme von Rohstoffe aus Steinbrüchen führen zu sensible Weise zum Schutz der natürlichen Ressourcen bei.

RÉUTILISATION DE 100% DES DÉCHETS BRUTS

100% des déchets bruts sont réutilisés pendant la phase de préparation de la pâte, réduisant l'extraction de matières premières minières contribuant sensiblement à la préservation des ressources naturelles.



RIUTILIZZO/RICICLO DEL 100% DEGLI SCARTI COTTI

Gli scarti cotti sono completamente riutilizzati nel ciclo produttivo. Inoltre, a fine vita, le piastrelle Panaria possono essere riciclate come inerti per sottofondi di strade ed edifici, riducendo così l'uso di ghiaia ed inerti naturali comunemente utilizzati in edilizia.

100% REUSE/RECYCLING OF THE INDUSTRIAL WASTE - FIRED TILES

The waste-fired tiles are fully reused in the production cycle. In addition, at the end of life, the tiles Panaria can be recycled as materials for substrates for roads and buildings, thus reducing the use of gravel and natural aggregates commonly used in building.

VERWERTUNG ZU 100% DER BEIM BRENNEN DER FLIESEN ANFALLENDEN ABFÄLLE

Gekochte Abfälle werden im Produktionskreislauf vollständig wiederverwendet. Auch am Ende ihres Lebens wird die Panaria-Fliesen können als Zuschlagstoffe für Straßen- und Bausubstrate recycelt werden, wodurch der Einsatz von Kies und natürlichen Zuschlagstoffen, die häufig im Bauwesen verwendet werden, reduziert wird.

RECYCLAGE À 100% DES DÉCHETS CUITS

Les déchets cuits, sont complètement recyclés dans le cycle de production. En outre, à la fin de la vie, les carreaux Panaria peuvent être recyclés comme matériaux inertes pour les couches de fondation des routes et des bâtiments, réduisant ainsi l'utilisation de gravillons et en matériaux inertes naturels communément utilisés par l'industrie du bâtiment.



RICICLO DEL 100% DEI RIFIUTI NON CERAMICI

Il 100% rifiuti non ceramici derivanti dalle attività produttive è gestito in modo differenziato e riciclato in altri processi produttivi.

100% OF NON CERAMIC WASTE

Is differentiated and recycled in other production cycles.

100% RECYCLING DES NICHT KERAMISCHEN ABFALLS

100% des während dem Produktionsprozess anfallenden keramischen Abfalls wird getrennt gesammelt und von öffentlich-rechtlichen Entsorgungsfachbetrieben recycelt.

RECYCLAGE À 100% DES DÉCHETS NON CÉRAMIQUES

100% des déchets non céramique provenant des activités de fabrication, sont triés de façon sélective et recyclés auprès d'entreprises extérieures autorisées.



RIUTILIZZO DEL 100% DELLE ACQUE DI PROCESSO

Per salvaguardare questa importante risorsa naturale Panaria riutilizza il 100% delle acque derivanti dal ciclo di produzione, riducendo fino all'80% il fabbisogno idrico degli stabilimenti.

100% WATER RECYCLING

The water used in the production process is 100% recycled. The water demand is reduced up to 80% by this mean. No industrial water is discharged in the ecosystem.

WIEDERVERWERTUNG VON 100% DES ABWASSERS

Um diese wichtige Naturressource zu schützen, verwertet Panaria Ceramica 100% der Abwässer des Produktionszyklus wieder und ermöglicht somit eine Reduktion des Wasserbedarfs in den Anlagen um 80%.

REUTILISATION À 100% DES EAUX DE TRAITEMENT

Pour préserver cette ressource naturelle importante Panaria Ceramica réutilise 100% des eaux provenant du cycle de production, générant une réduction jusqu'au 80% des besoins hydrauliques des usines.



MINIME EMISSIONI IN ATMOSFERA

L'uso delle migliori tecnologie produttive permette di ridurre al minimo le emissioni in atmosfera, con livelli 10 volte inferiori ai severi limiti ambientali richiesti della legislazione italiana.

LOW EMISSIONS IN THE ATMOSPHERE

Panaria complies strictly to Italian Standards with a very small amount of gas emissions in the atmosphere. The high quality of the technology used keeps our emissions 10 times inferior the allowed limits.

NIEDRIGE EMISSIONSWERTE

Der Einsatz der besten Produktionstechnologien ermöglicht es, die Emissionen in die Atmosphäre zu minimieren, wobei die Werte 10-mal niedriger sind als die strengen Umweltgrenzwerte, die von der italienischen Gesetzgebung gefordert werden.

BASSES ÉMISSIONS DANS L'ATMOSPHÈRE

L'utilisation des meilleures technologies de production permettent de minimiser les émissions de gaz dans l'atmosphère, atteignant des niveaux dix fois inférieurs aux limites environnementales très sévères fixées par la législation italienne.



FORTE RIDUZIONE DEI CONSUMI ENERGETICI

L'uso di tecnologie all'avanguardia e di soluzioni impiantistiche ottimali riducono sensibilmente l'uso di gas metano nel processo produttivo.

METHANE CONSUMPTION IS HIGHLY REDUCED

By the use of up to date technologies and customized installations.

BEACHTLICHE REDUZIERUNG DES ENERGIEBEDARFS

Der Einsatz fortschrittlicher Technologien und optimaler Lösungen beim Bau der Anlagen reduzieren den Einsatz von Methangas beim Produktionsprozess auf beachtliche Weise.

FORTE RÉDUCTION DES CONSOMMATIONS ÉNERGÉTIQUES

L'utilisation de technologies de pointe et de solutions d'installations optimales permettent de réduire considérablement la consommation de gaz méthane dans le processus de production.



UTILIZZO DI IMBALLAGGI 100% RICICLABILI

I materiali impiegati per gli imballaggi dei prodotti Panaria Ceramica (scatole, cartone, termoretraibili, reggette, pallet di legno) sono completamente riciclabili.

PANARIA PACKING MATERIAL IS 100% RECYCLABLE

(carton boxes, plastic packaging materials, wooden pallets, straps, etc...).

VERWENDUNG VON 100% RECYCLEBAREN VERPACKUNGEN

Die Materialien, die zur Verpackung der Produkte von Panaria Ceramica verwendet werden (Schachteln, Kartons, Kunststoffe, Holzpaletten, usw.) sind vollständig recyclebar.

UTILISATION D'EMBALLAGES 100% RECYCLABLES

Les matériaux utilisés pour les emballages des produits Panaria Ceramica (boîtes, carton, plastique, palettes en bois, etc.) sont complètement recyclables.



PALLET FAO

Panaria Ceramica utilizza pallet senza corteccia (DB) conformi allo standard IPPC / FAO ISPM 15, offrendo quindi ai Paesi importatori ogni garanzia per la salvaguardia del proprio patrimonio forestale.

PALLET FAO

Panaria uses debarked pallets (DB) for its shipments, in accordance with the IPPC/FAO ISPM 15 standards. This is a further warranty for the forest safeguard of the importing Countries, dealing with PANARIA.

FAO-PALETTE

Panaria Ceramica verwendet gemäß dem Standard IPPC/FAO ISPM 15 Paletten ohne Rinde (DB) und gibt daher den Importländern die Garantie, den eigenen Waldbestand zu schützen.

PALETTES FAO

Panaria Ceramica utilise des palettes sans écorce (DB) conformes aux normes IPPC/FAO ISPM 15, offrant donc aux pays importateurs la garantie de la préservation du patrimoine forestier.



CERTIFICAZIONI AMBIENTALI ISO 14001, EMAS ed EPD

Gli stabilimenti produttivi Panaria possiedono Sistemi di Gestione Ambientale certificati ISO 14001 ed EMAS (Regolamento CE N. 1221/2009).

I prodotti Panaria possiedono la certificazione EPD specifica di Tipo III, certificata da Ente indipendente di terza parte secondo EN 15804 ed EN 14025.

ISO 14001, EMAS AND EPD ENVIRONMENTAL CERTIFICATIONS

Panaria tiles are produced in manufacturing plants with environmental management systems compliant to ISO 14001 and EMAS (EC Regulation 1221/2009).

Panaria products have a type III specific EPD. This is certified by an independent third party according to EN 14025 and EN 15804 standards.

UMWELTZERTIFIKATE ISO 14001, EMAS ED EPD

Die Panaria Produktionsanlage besitzen die Umweltzertifizierung ISO 14001 und EMAS (Regelung CE N. 1221/2009).

Die Produkte von Panaria und Fiorido besitzen die Zertifizierung EPD spezifisch von Typ III, von unabhängigen und fremden Anstalt gemäß EN 15804 und EN 14025 zertifiziert.

CERTIFICATIONS ENVIRONNEMENTALES ISO 14001, EMAS ET EPD

Les sites productif Panaria sont équipés de Système de Gestion Environnementale certifié ISO 14001 et EMAS (règlement CE N. 1221/2009).

Les produits Panaria sont certifiés EPD spécifique de Type III, la certification est effectuée par un organisme indépendant tiers comme prévu par EN 15804 et EN 14025.



Panaria e l'ambiente

Panaria and the environment_Panaria und die Umwelt_Panaria et l'environnement

Crediti LEED V4

LEED V4 Credits_Kredite LEED V4_Crédits LEED V4

Panaria è membro del U.S. Green Building Council e del Green Building Council ITALIA, organizzazioni che promuovono la realizzazione di edifici ed opere nel rispetto dell'ambiente, della salute e del benessere delle persone che ci vivono e lavorano. LEED V4 nasce da U.S. Green Building Council per offrire a progettisti, architetti e costruttori un nuovo strumento per realizzare edifici secondo standard più esigenti in termini di sostenibilità, salubrità e vivibilità. Anche per i materiali da costruzione, tra cui le piastrelle di ceramica, vengono richiesti requisiti più severi e più completi, tra cui anche la Dichiarazione Ambientale EPD.

• **Le schede LEED delle serie Panaria sono disponibili su richiesta, sia secondo il protocollo LEED V4 che secondo i protocolli del GBC Italia.**

Panaria is a member of the U.S. Green Building Council and of the Green Building Council ITALIA. These organizations promote the construction of buildings and other works which respect the environment as well as the health and well-being of the people who live and work within them. LEED V4 was created by the U.S. Green Building Council to provide designers, architects, and builders with a new tool for the construction of buildings that adhere to more elevated standards of sustainability, health, and liveability.

More stringent and thorough requisites are required of building materials, like ceramic tiles, including the Environmental Product Declaration (EPD).

• The LEED data sheets for Panaria are available upon request, according to both the LEED V4 and GBC Italia protocols.

Panaria ist ein Mitglied des US-Green Building Councils und des Green Building Councils ITALIEN, beides Organisationen, die den Bau von Gebäuden und Strukturen unter Beachtung der Umwelt, Gesundheit und des Wohlbefindens der Menschen, die darin leben und arbeiten fördern. LEED V4 ist ein Projekt des US-Green Building Councils, um Designern, Architekten und Konstrukteuren ein neues Instrument zu liefern, Gebäude gemäß den anspruchsvollsten Standards in Bezug auf Nachhaltigkeit, Gesundheit und Lebensqualität zu realisieren. Auch für Baumaterialien, einschließlich keramischer Fliesen, werden strengere und vollständiger Anforderungen, einschließlich der Umwelterklärung EPD verlangt.

• Die LEED-Karten der Serie Panaria sind auf Anfrage erhältlich, sowohl gemäß dem Protokoll LEED-V4 als auch gemäß den Protokollen des GBC Italien.

Panaria est membre de l'U.S. Green Building Council et du Green Building Council d'Italie.

Ces organisations promeuvent la réalisation de bâtiments et de travaux qui respectent l'environnement, la santé et le bien-être des personnes qui travaillent à la réalisation et de celles pour lesquelles elle est destinée. LEED V4 a été créé par U.S. Green Building Council pour offrir aux designers, architectes et constructeurs, un nouvel outil capable de répondre aux dernières exigences de réalisation en termes de durabilité, salubrité et bien-être. Pour les matériaux de construction, tels que les carreaux en céramique, les exigences sont encore plus sévères et plus complètes, et doivent être accompagnés notamment d'une Déclaration Environnementale Produit (DEP).

• Les fiches LEED des séries Panaria sont disponibles sur demande, selon le protocole LEED V4 ainsi que selon les protocoles GBC Italie.



GREENGUARD GOLD

Tutte le collezioni Panaria in gres porcellanato e ZERO.3 hanno ottenuto la certificazione GREENGUARD GOLD, cioè lo standard di UL con i limiti più stringenti di emissioni di VOC, e sono perciò in grado di assicurare la migliore salubrità alle persone che vivono e che abitano gli ambienti. Per questo possono essere impiegate in ambienti come scuole e strutture sanitarie, frequentate da soggetti sensibili come i bambini e gli anziani. GREENGUARD GOLD è una certificazione ampiamente riconosciuta e richiesta dai programmi di edilizia sostenibile e dai regolamenti di progettazione e costruzione in tutto il mondo, come il LEED (internazionale) e il BREEAM (UK).

All porcelain stoneware and ZERO.3 Panaria collections have obtained GREENGUARD GOLD certification, i.e. the UL standard with the strictest VOC emission limits, and are therefore able to ensure that they are as healthy as possible for the people who use and inhabit these environments. They can therefore be used in environments such as schools and health facilities, attended by sensitive individuals such as children and the elderly. GREENGUARD GOLD is a widely recognised certification required by sustainable building programmes and design and construction regulations around the world, such as LEED (international) and BREEAM (UK).

Toutes les collections Panaria en grès cérame et ZERO.3 ont obtenu la certification GREENGUARD GOLD, qui est le standard de UL ayant les critères les plus sévères en matière d'émission de COV, et elles sont en mesure de garantir la meilleure salubrité aux personnes qui vivent et habitent les pièces. Elles peuvent donc être utilisées dans des locaux comme les structures sanitaires, fréquentées par des individus sensibles tels que les enfants et les personnes âgées.

GREENGUARD GOLD est une certification amplement reconnue et exigée par les programmes de bâtiment durable et par les règlements de conception et construction du monde entier, comme le LEED (international) et le BREEAM (GB).

Alle Panaria Kollektionen aus Feinsteinzeug und ZERO.3 haben die GREENGUARD GOLD-Zertifizierung, d.h. den UL-Standard mit den strengsten Beschränkungen für VOC-Emissionen erhalten, und sind somit in der Lage, den Bewohnern der Räume maximale Gesundheit zu garantieren. Deshalb können sie in Umgebungen wie Schulen und Gesundheitseinrichtungen eingesetzt werden, die von empfindlichen Personen wie Kindern und älteren Menschen besucht werden.

GREENGUARD GOLD ist eine weithin anerkannte Zertifizierung, die von nachhaltigen Bauprogrammen sowie weltweiten Planungs- und Baubewertungssystemen wie LEED (international) und BREEAM (Vereinigtes Königreich) gefordert wird.



Panaria e l'ambiente

Panaria and the environment_Panaria und die Umwelt_Panaria et l'environnement

EPD - Dichiarazione Ambientale di Prodotto

EPD - Environmental Product Declaration_EP D - Umwelt-Produktdeklaration
DEP - Déclaration Environnementale Produit



La Dichiarazione Ambientale di Prodotto (EPD) comunica in modo trasparente le prestazioni ambientali del gres porcellanato Panaria basandosi sull'analisi del ciclo di vita (LCA).

I prodotti Panaria possiedono EPD specifica di tipo III, certificata da ente terzo indipendente secondo le normative EN 14025 e EN 15804 (PCR di riferimento).

I Prodotti certificati EPD sono richiesti dai principali sistemi di certificazione degli edifici quali LEED (internazionale), BREEAM (Inghilterra), HQE (Francia) e DGNB (Germania), nonché in schemi legislativi in Italia (requisiti per appalti pubblici sostenibili).

È una certificazione volontaria, che valorizza ancor più i materiali Panaria perché prodotti secondo i migliori standard di sostenibilità e responsabilità.

The Environmental Product Declaration (EPD) is a transparency tool that communicates the environmental performances of Panaria porcelain tile through a Life Cycle Assessment (LCA).

Panaria products have a type III specific EPD. This is certified by an independent third party according to EN 14025 and EN 15804 standards (applicable PCR). EPD certified products are required by the main construction certifying bodies such as LEED (international), BREEAM (England), HQE (France), and DGNB (Germany), as well as the legislative frameworks in Italy (requisites for sustainable public contracts).

It is a voluntary certification that gives additional value to Panaria products because they are manufactured according to the highest standards of sustainability and responsibility.

Die Umwelt-Produktdeklaration (EPD) teilt in einer transparenten Art und Weise die Umweltleistung von Feinsteinzeug Panaria auf der Grundlage der "Lebenszyklusanalyse" (LCA) mit.

Die Produkte Panaria verfügen über eine EPD vom Typ III, die von einem unabhängigen Dritten nach den Normen EN 14025 und EN 15804 (Referenz-PCR) zertifiziert wurde. EPD-zertifizierte Produkte werden von den wichtigsten Gebäudezertifizierungssystemen gefordert, wie z.B. LEED (International), BREEAM (England), HQE (Frankreich) und DGNB (Deutschland), sowie in Gesetzgebungsregelungen in Italien (Anforderungen für nachhaltige öffentliche Beschaffung) verlangt wird.

Es ist eine freiwillige Zertifizierung, die die Materialien Panaria Produkte weiter aufwertet, da sie nach den höchsten Standards der Nachhaltigkeit und Verantwortung produziert werden.

La Déclaration Environnementale Produit (DEP) communique de manière transparente les performances environnementales du grès cérame Panaria en se basant sur l'analyse du cycle de vie (ACV).

Les produits Panaria possèdent la déclaration environnementale (DEP) de type III, certifiée par un tiers indépendant conformément aux normes EN 14025 et EN 15804 (PCR de référence). Les produits certifiés DEP sont requis par les principaux organismes de certification pour la construction comme LEED (pour l'international), BREEAM (Angleterre), HQE (France) et DGNB (Allemagne), et par les cadres législatifs prévus en Italie (conditions pour participer aux marchés publics durables).

Cette certification est une démarche volontaire, et vise à apporter une valeur supplémentaire aux matériaux Panaria, fabriqués de manière responsable et selon les meilleurs standards écologiques.

Contenuto di materiale riciclato 40%

Recycled content 40%_Inhaltverhalten von wiederverwertetem Material 40%_Contenu de matériel recyclé 40%



Panaria: piastrelle ecologiche studiate per riutilizzare nell'impasto ceramico materiale riciclato proveniente da altri processi produttivi.

Questo si traduce in un minore utilizzo di risorse naturali ed un maggior rispetto per l'ambiente.

• Le serie certificate 40% sono indicate all'interno del catalogo generale e sul sito www.panaria.it

Panaria: ecological tiles made with recycled material coming from other previous productions.

This involves a lower use of natural resources and helps respecting the environment.

• The series certified 40% are shown inside the general catalogue and in our website www.panaria.it

Panaria: Ökologische Fliesen, die Zur Wiederverwendung in Keramikmischung von recycelten Material aus anderen Produktionsprozessen spezifisch geplant sind.

Dies bedeutet eine sparsamere Nutzung der natürlichen Ressourcen und einer größeren Respekt für die Umwelt.

• Die Serien mit 40% Zeugnis sind auf del Generalkatalog und auf den Web-site www.panaria.it hingewiesen.

Panaria: des carreaux écologiques étudiés pour réutiliser dans le mélange céramique les matières recyclées provenant d'autres procès productifs. Ce qui assure une consommation moindre des ressources naturelles et un plus grand respect de l'environnement.

• Les séries certifiées 40% sont indiquées dans le catalogue général et sur notre site-web www.panaria.it

CERTIFICATO / CERTIFICATE
N. P1172
SI CERTIFICA CHE IL PRODOTTO / WE HEREBY CERTIFY THAT THE PRODUCT
PIASTRELLE DI CERAMICA REALIZZATE CON MATERIALE RICICLATO
CERAMIC TILES PRODUCED WITH RECYCLED MATERIALS
(dettagli negli allegati / details in annexes 1-2-3-4-5-6)
DELL'ORGANIZZAZIONE / OF THE ORGANIZATION
PANARIAGROUP INDUSTRIE CERAMICHE S.p.A.
41034 FINALE EMILIA (MO) - Via Panaria Bassa 22/A
E CONFORME A / COMPLIES WITH
DT 55 ED 02 100915
DOCUMENTO TECNICO PER LA CERTIFICAZIONE DI PRODOTTO RELATIVA A PRODOTTI PER L'EDILIZIA CON PERCENTUALE INDICATA DI MATERIALE RICICLATO.
PIASTRELLE DI CERAMICA E SEMILAVORATI DA UTILIZZARSI PER LA LORO PRODUZIONE
TECHNICAL DOCUMENT FOR PRODUCT CERTIFICATION OF CONSTRUCTION PRODUCTS WITH THE SPECIFIED PERCENTAGE OF RECYCLED MATERIAL.
CERAMIC TILES AND SEMI-FINISHED ITEMS FOR THE PRODUCTION THEREOF
CERTIFICAZIONE "SYSTEM 8" SECONDO ISO/IEC GUIDE 67:2004
Il presente certificato non è da ritenersi valido se non accompagnato dai relativi allegati
This certificate is not valid without the relevant Annexes
IL PRESENTE CERTIFICATO È SOGGETTO AL RISPETTO DEL REGOLAMENTO PER LA CERTIFICAZIONE DI CONFORMITÀ DI PRODOTTO
THIS CERTIFICATE IS SUBJECT TO FULFILLMENT OF THE REGULATIONS APPLYING TO PRODUCT CERTIFICATION
PRIMA EMISSIONE 28/07/2009
EMMISSIONE CORRENTE 03/07/2018
DATA DI SCADENZA 02/07/2021
CERTIQUALITY S.r.l.

ALLEGATO 1 AL CERTIFICATO / ENCLOSURE TO CERTIFICATE N. P1172

SERIE DI PRODOTTO PIASTRELLE IN CERAMICA MARCHIO/BRAND	SERIE/SERIES	STABILIMENTO PRODUCTION SITE	MATERIALE RICICLATO RECYCLED MATERIAL	
			% PRE-CONSUMO PRE-CONSUMER	% POST-CONSUMO POST-CONSUMER
PANARIA CERAMICA	Banale	Toano	≥ 40%	0
	Crosswood	Finale Emilia	≥ 40%	0
	Assi d'Alpe	Finale Emilia	≥ 40%	0
	Boarsh	Finale Emilia	≥ 40%	0
	Memory Mood	Finale Emilia	≥ 40%	0
	Petra Solis	Finale Emilia	≥ 40%	0
	Horizon	Toano	≥ 40%	0
	Contred	Toano	≥ 40%	0
	Pietre di Fanes	Finale Emilia	≥ 40%	0
	Discover	Finale Emilia	≥ 40%	0
	Urbanature	Finale Emilia	≥ 40%	0
	North Cape	Toano	≥ 40%	0
	Grance	Toano	≥ 40%	0
	Prime Stone	Toano	≥ 40%	0
	Trisgr	Toano	≥ 40%	0
	Chic wood	Toano	≥ 40%	0

Prodotte presso gli stabilimenti di Finale Emilia e Toano / Produced in Finale Emilia and Toano production sites.
IL PRESENTE ALLEGATO NON È DA RITENERSI VALIDO SE NON ACCOMPAGNATO DAL RELATIVO CERTIFICATO.
THIS ANNEX IS NOT VALID WITHOUT THE RELEVANT CERTIFICATE.
PRIMA EMISSIONE 28/07/2009
EMMISSIONE CORRENTE 03/07/2018
DATA DI SCADENZA 02/07/2021
CERTIQUALITY S.r.l.

Panaria e l'ambiente

Panaria and the environment_Panaria und die Umwelt_Panaria et l'environnement

Certificazioni ambientali EMAS dei siti produttivi

EMAS Approved Environmental Management System of production sites_Umweltzertifizierung EMAS der Produktionsstätten
Système de Management environnemental Certificat EMAS des sites de production

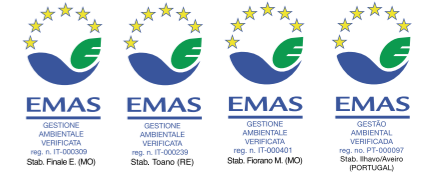

Il sistema comunitario di ecogestione ed audit EMAS è lo strumento con cui l'Unione Europea promuove il miglioramento continuo delle prestazioni ambientali delle organizzazioni - rif. Regolamenti (CE) 1221/2009 e (UE) 2017/1505 del Parlamento Europeo e del Consiglio. Panariagroup Industrie Ceramiche S.p.A. ha ottenuto la registrazione EMAS per tutti i suoi siti produttivi di Toano (RE) (N. registrazione I-000239), Finale Emilia (MO) (N. registrazione I-000309), Fiorano Modenese (MO) (N. registrazione I-000401) e Ilhavo/Aveiro (Portogallo) (N. registrazione PT-000097).

Questa registrazione riveste una grande importanza, perché impone la creazione di un vero Sistema di gestione Ambientale basato sul continuo miglioramento delle proprie prestazioni ambientali. Il sistema si basa sulla creazione di un rapporto di collaborazione e fiducia con le istituzioni del territorio (Enti, Autorità, Associazioni, Rappresentanze Sindacali, Scuole, Stampa) e con il pubblico, ed è prevista la partecipazione attiva di tutti i dipendenti.

La Dichiarazione Ambientale è il documento finale che descrive gli aspetti ambientali e di sicurezza sul lavoro, le prestazioni ambientali del sito e gli obiettivi ambientali che l'Azienda si impone di raggiungere nell'ottica del miglioramento continuo. La dichiarazione è convalidata da un Verificatore Ambientale Accreditato a seguito verifiche ispettive (audit) eseguite in stabilimento. Panaria è tra le pochissime aziende ceramiche ad avere la registrazione EMAS, che, insieme alla Ecolabel ed alla certificazione qualità ISO 14001, testimonia la massima attenzione e sensibilità del management alle questioni etiche, ambientali, di sicurezza e qualità.

The Community Eco-Management and Audit Scheme (EMAS) is the tool through which the European Union promotes continuous improvement of the environmental performance of organizations - ref. Regulations (CE) 1221/2009 and (UE) 2017/1505 of the European Parliament and Council. Panariagroup Industrie Ceramiche S.p.A. has obtained EMAS Registration for all its production sites: Finale Emilia (MO) (registration N° I-000309), Toano (RE) (registration N° I-000239), Fiorano Modenese (MO) (registration N° I-000401) and Ilhavo/Aveiro (Portugal) (registration N° PT-000097).

This registration is of major importance, since it requires a proper Environmental Management System to be created, based on the continual improvement of environmental performance within organisations.

The scheme is based on the creation of an open dialogue with local institutions (Agencies, Authorities, Associations, Trade Union Representatives, Schools, Press) and with the public, and it is expected that all employees will play an active part.

The Environmental Statement is the end document that describes the environmental and safety aspects in the workplace, the environmental performance of the site and the environmental targets that the Company sets itself within the framework of continual improvement.

The statement is validated by an Accredited Environmental Verifier, following audits carried out in the plant. Panaria is one of the very few ceramics companies to have EMAS registration which, together with the Ecolabel and ISO 14001 quality certification, bear witness to the management's utmost commitment and readiness to engage with the ethical, environmental, safety and quality issues.

Das Gemeinschaftssystem für Umweltmanagement und Umweltbetriebsprüfung EMAS ist das Instrument, mit dem die Europäische Union die kontinuierliche Verbesserung der Umwelleistung von Organisationen fördert - vgl. Verordnungen (EG) Nr. 1221/2009 und (EU) 2017/1505 des Europäischen Parlaments und des Rats.

Panariagroup Industrie Ceramiche S.p.A. ha die EMAS Registrierung für alle Produktionsstätten erhalten: Toano (RE) (Registrierungsnummer I-000239), Finale Emilia (MO) (Registrierungsnummer I-000309), Fiorano Modenese (MO) (Registrierungsnummer I-000401) und Ilhavo/Aveiro (Portugal) (Registrierungsnummer PT-000097). Diese Registrierung hat eine große Bedeutung, da sie die Schaffung eines wahren Umweltmanagement - systems auf der Grundlage der kontinuierlichen Verbesserung der Effizienz des Umweltcontrollings impliziert.

Das System basiert auf dem Aufbau einer kooperativen und von gegenseitigem Vertrauen geprägten Beziehung mit den territorialen Institutionen (öffentlichen Einrichtungen, Behörden, Verbänden, gewerkschaftlichen Vertretungen, Schulen, Presse) und der Öffentlichkeit. Des Weiteren ist die aktive Einbeziehung des gesamten Personals vorgesehen. Die Umweltschutzklärung ist das endgültige Dokument, in dem die Aspekte zum Umweltschutz und zur Sicherheit am Arbeitsplatz, die Initiativen zum Schutz der Umwelt an diesem Standort sowie die Ziele beschrieben werden, die das Unternehmen im Rahmen des kontinuierlichen Verbesserungsprozesses erreichen will.

Die Erklärung wird von einem zugelassenen Umweltgutachter nach vor Ort durchgeführten Inspektionen (Audits) genehmigt. Panaria ist einer der wenigen Keramikerhersteller, der eine EMAS-Registrierung vorweisen kann, die, gemeinsam mit Ecolabel und dem Qualitätszertifikat ISO 14001, das große Engagement und die Sensibilität des Unternehmens in bezug auf Ethik, Umweltschutz, Sicherheit und Qualität unter Beweis stellt.

Le Système communautaire de Management environnemental et d'Audit est un instrument employé par l'Union européenne pour promouvoir l'amélioration constante des performances environnementales des organisations. - Référence : Règlements (CE) n° 1221/2009 et (UE) 2017/1505 du Parlement européen et du Conseil. Panariagroup Industrie Ceramiche S.p.A. a obtenu l'accréditation EMAS pour les trois sites de production: Finale Emilia (MO) (accréditation N° I - 000309), Toano (RE) (accréditation N° I-000239), Fiorano Modenese (MO) (accréditation N° I-000401) et Ilhavo/Aveiro (Portugal) (accréditation N° PT-000097).

Cette certification revêt une grande importance, car elle sous-entend la création d'un véritable Système de gestion de l'environnement, basé sur la perpétuelle amélioration des résultats obtenus en matière d'environnement. Le système repose sur la création d'un rapport de collaboration et de confiance avec les institutions du territoire (Institutions, Pouvoirs publics, Associations, Représentations syndicales, Écoles, Presses) et avec le public. Il est prévu que tous les employés participeront activement à ce programme. La Déclaration environnementale constitue le document final décrivant les éléments en matière d'environnement et de sécurité sur le lieu de travail, les efforts effectués par le site pour l'environnement et les objectifs que l'entreprise s'est fixés dans le cadre de cette amélioration perpétuelle.

La déclaration a été validée par un Contrôleur officiel suite aux inspections (audit) effectuées sur le site. Panaria fait partie des rares entreprises actives dans le domaine de la céramique disposant du certificat EMAS, qui, à l'instar de l'Ecolabel et du certificat de qualité ISO 14001, témoigne de la plus grande attention et de la sensibilité de la part de la direction en ce qui concerne les questions éthiques, environnementales, de sécurité et de qualité.



Panaria e l'ambiente

Panaria and the environment_Panaria und die Umwelt_Panaria et l'environnement

Sistema di gestione ambientale dei siti produttivi

Environmental system of production sites_Umweltmanagement system der produktionsstätten
Système de management environnemental des sites de production

Sistema di gestione ambientale certificato UNI EN ISO 14001 dei siti produttivi

UNI EN ISO 14001 approved environmental system of production sites

Umweltmanagement system nach UNI EN ISO 14001 der produktionsstätten

Système de management environnemental certifié UNI EN ISO 14001 des sites de production

UNI EN ISO 14001:2015



CERTIFIED ENVIRONMENTAL MANAGEMENT SYSTEM

Certificazioni di qualità

Quality certifications_Qualitätszertifikat_Certifications de qualité

Sistema di qualità certificato UNI EN ISO 9001

UNI EN ISO 9001 approved quality system_Qualitätssystem nach UNI EN ISO 9001
Système qualité certifié UNI EN ISO 9001

UNI EN ISO 9001:2015



CERTIFIED QUALITY MANAGEMENT SYSTEM



Certificazioni di qualità

Quality certifications_Qualitätszertifikat_Certifications de qualité

COLLEZIONE COLLECTION COLLECTION COLLECTION	 UPEC	 UPEC-F+ (Épaisseur 20 mm)	
ASSI D'ALPE			•
BASALIKE			•
BIOARCH	•	•	•
CHIC WOOD			•
CONTEXT	•	•	•
CROSS WOOD			•
DISCOVER	•	•	•
ETERNITY			•
GLANCE			•
HORIZON	•	•	•
MEMORY MOOD	•	•	•
NORTH CAPE			•
NUANCE			•
OPIFICIO 22/A			•
PIERRE DES RÊVES			•
PETRA SOLIS	•	•	•
PIETRE DI FANES	•		•
PRIME STONE		•	•
TRILOGY			•
URBANATURE	•	•	•
Linea Fiordo FRAME	•	•	•
Linea Fiordo GENESIS			•
Linea Fiordo IN WOOD			•
Linea Fiordo MOTION			•
Linea Fiordo ROCK STYLE			•
Linea Fiordo TRACKS		•	•
Linea Fiordo WOOD RELIVE			•

I classements UPEC dei singoli prodotti Panaria, compresi quelli delle nuove collezioni 2020, sono scaricabili dal sito www.cstb.fr o tramite il link <http://webapp.cstb.fr/upec-ceramique/index.php>. I certificati del contenuto di riciclato, compresi gli aggiornamenti 2020, sono scaricabili dal sito www.panaria.it alla sezione **Download/Certificazioni. The UPEC classifications of the individual Panaria products, including those in the new 2020 collections, can be downloaded from www.cstb.fr or via the link <http://webapp.cstb.fr/upec-ceramique/index.php>. Recycled content certificates, including the 2020 updates, can be downloaded from www.panaria.it in the Downloads/Certifications section. Les classements UPEC de chaque produit Panaria, y compris ceux des nouvelles collections 2020, peuvent être téléchargés sur le site www.cstb.fr ou à travers le lien <http://webapp.cstb.fr/upec-ceramique/index.php>. Les certificats sur la teneur en matière recyclée, y compris les mises à jour 2020, peuvent être téléchargés sur le site www.panaria.it dans la section Téléchargement /Certificazioni. Die UPEC-Klassifizierungen der einzelnen Produkte von Panaria, darunter auch jene der neuen Kollektionen 2020, können von der Seite www.cstb.fr oder über den Link <http://webapp.cstb.fr/upec-ceramique/index.php> heruntergeladen werden. Die Zertifikate zum Recyclinganteil, darunter auch die Aktualisierungen 2020, können von der Seite www.panaria.it im Bereich Download/Zertifizierungen heruntergeladen werden.**



UNI-CERTIQUALITY / KEY MARK
I certificati sono disponibili su richiesta
 Certificates are available upon request
 Les certificats sont disponibles sur demande
 Zertifikate sind auf Anfrage erhältlich



Marchio europeo CE di sicurezza

CE Security Mark_Europäisches CE Sicherheitszeichen_Certificat européen de sécurité CE

La marcatura CE è la certificazione di sicurezza del prodotto richiesta dall'Unione Europea, ed ha lo scopo di salvaguardare la salute delle persone e i beni nelle opere di costruzione. Il nuovo Regolamento UE N. 305/2011 è in vigore il 1 luglio 2013. La novità più rilevante è l'introduzione della Dichiarazione di Prestazione (DOP, Declaration Of Performance) con la quale il fabbricante comunica i requisiti di sicurezza dei propri materiali. Le lastre in gres porcellanato Zero.3 3Plus - Zero.3 5Plus - Zero.3 6mm sono in possesso del marchio CE (cfr. DOP004PAN - cfr. DOP005PAN - cfr. DOP006PAN). L'applicazione sul retro di una rete in fibra di vetro conferisce a questi prodotti le classi di reazione al fuoco indicate su questo catalogo nelle tabelle tecniche Zero.3.

Le DOP di Panaria sono disponibili sul sito internet www.panaria.it

The CE mark is the safety product certification required by EU and it is finalized to preserve the people's health and the goods in buildings. The new Regulation UE N. 305/2011 is valid from the first of July 2013. The most important news is the introduction of the Declaration Of Performance (DOP) with which the supplier communicates the safety requirements concerning own materials. Zero.3 3Plus - Zero.3 5Plus - Zero.3 6mm porcelain stoneware slabs have the CE mark (cf. DOP004PAN - cf. DOP005PAN - cfr. DOP006PAN). The application of a fibreglass mesh on the back confer to these products the categories of fire resistance indicated in the Zero.3 technical tables.

Panaria DOP are available on the website www.panaria.it

Das CE- Kennzeichnung ist die von EU angefragte Zertifizierung für die Produkt- Sicherheit, und hat das Zweck die Gesundheit der Menschen zu schützen und die Güter in der Bauphase zu bewahren. Die neue Regelung UE N. 305/2011 tritt am 1.07.2013 in Kraft. Die wichtigste Neuheit ist die Einfügung der Leistungserklärung (DOP, Declaration Of Performance), mit der der Hersteller die Sicherheitsanforderungen eigenen Materialien mitteilt. Die Feinsteinzeugfliesen Zero.3 3Plus - Zero.3 5Plus - Zero.3 6mm sind mit dem CE-Markenzeichen versehen (siehe DOP004PAN - siehe DOP005PAN - cfr. DOP006PAN). Die Anwendung eines Glasfasernetzes auf der Rückseite der Fliesen verleiht diesen Produkten die in den technischen Tabellen Zero.3 aufgeführten Brandklassen.

Die DOP Panaria sind auf Internet Site www.panaria.it verfügbar

L'Union Européenne définit avec la marque CE est la certification de sécurité des produits demandé par l'Union Européenne ayant comme objectif la protection et la santé des personnes et des biens dans les ouvrages du bâtiments. Le nouveau Règlement UE Nr. 305/2011 est entré en vigueur le 1^{er} Juillet 2013. La nouveauté la plus importante est l'introduction de la Déclaration de Prestation (DOP, Declaration Of Performance) par la quelle le fabricant communique les caractéristiques de sécurité de ses produits. Les dalles en grès cérame Zero.3 3Plus - Zero.3 5Plus - Zero.3 6mm possèdent le marquage CE (cfr. DOP004PAN - cfr. DOP005PAN - cfr. DOP006PAN). L'application d'une couche en fibre de verre au dos de chaque dalle confère aux produits une haute résistance au feu. La classe de résistance des dalles est disponible dans les tableaux techniques Zero.3.

Les DOP de Panaria sont disponibles sur le site internet www.panaria.it

DOP001PAN DOP002PAN DOP004PAN DOP005PAN DOP006PAN
05
PANARIA CERAMICA Via Panaria Bassa n° 22/a - 41034 Finale Emilia (MO) - Italy Panariagroup Industrie Ceramiche SpA
EN 14411
Panaria Ceramica Porcelain Tiles: Dry-pressed ceramic tiles with low water absorption E ≤ 0,5% for flooring and wall finishes, internal and external applications (DOP001PAN).
Panaria Ceramica Wall Tiles: Dry-pressed ceramic tiles with water absorption level E > 10% for internal wall applications (DOP002PAN).
ZERO.3 3 Plus: Dry pressed ceramic tiles with low water absorption E ≤ 0,5% for internal flooring and internal and external wall applications (DOP004PAN).
ZERO.3 5 Plus: Dry pressed ceramic tiles with low water absorption E ≤ 0,5% for internal flooring and internal and external wall applications (DOP005PAN).
ZERO.3 6mm: Dry pressed ceramic tiles with low water absorption E ≤ 0,5% for internal flooring and internal and external wall applications (DOP006PAN).

Indice alfabetico dei prodotti

List of products in alphabetical order_Alphabetisches verzeichnis der Produkte_Index alphabétique des produits

PRODOTTO PRODUCT PRODUKT PRODUIT	TECNOLOGIA TECHNOLOGY TECHNOLOGIE TECHNOLOGIE	SPESSORE THICKNESS STÄRKE ÉPAISSEUR	SERIE SERIES SÉRIE SÉRIE	EFFETTO LOOK OPTIK ASPECT	PAGINA PAGE SEITE PAGE
A					
ALASKA	GRES SMALTATO_GLAZED PORCELAIN STONEWARE	9,5 mm	WOOD RELIVE Linea Fiordo	legno_wood	341
ARABESQUE PEARL lux	GRES PORCELLANATO LAMINATO_LAMINATED PORCELAIN STONEWARE	6 mm	ETERNITY	marmo_marble	253
	GRES A MASSA COLORATA_COLOURED-BODY STONEWARE	9,5 mm			
ARABESQUE PEARL soft	GRES PORCELLANATO LAMINATO_LAMINATED PORCELAIN STONEWARE	6 mm	OPIFICIO 22/A	cemento_concrete	221
	GRES A MASSA COLORATA_COLOURED-BODY STONEWARE	9,5 mm			
ARGILLA		8/9,5 mm	PIERRE DES RÊVES	pietra_stone	107
ARGILLA ext	GRES A MASSA COLORATA_COLOURED-BODY STONEWARE	9,5 mm			
ARGILLA strutturato		20 mm	TRACKS Linea Fiordo	pietra_stone	147
ASH	GRES A MASSA COLORATA_COLOURED-BODY STONEWARE	9,5 mm			
ASH strutturato		8/20 mm	PIERRE DES RÊVES	pietra_stone	107
AURORE	GRES A MASSA COLORATA_COLOURED-BODY STONEWARE	9,5 mm			
AURORE ext	GRES A MASSA COLORATA_COLOURED-BODY STONEWARE	9,5 mm	PIERRE DES RÊVES	pietra_stone	107
AURORE strutturato		12/20 mm			
B					
BADIA	GRES A MASSA COLORATA_COLOURED-BODY STONEWARE	9,5 mm	ASSI D'ALPE	legno_wood	283
BARGE GIALLA spazzolata		9,5 mm	BIOARCH	pietra_stone	49
BARGE GIALLA strutturato	GRES A MASSA COLORATA_COLOURED-BODY STONEWARE	9/12/20 mm			
BARGE GRIGIA spazzolata		9,5 mm			
BARGE GRIGIA strutturato		9/12/20 mm			
BE BLACK lux		5,5 mm	MUST	cromatico_chromatic	367
BE BLACK soft	GRES PORCELLANATO LAMINATO_LAMINATED PORCELAIN STONEWARE	5,5 mm			
BE WHITE lux		5,5 mm			
BE WHITE soft		5,5 mm			
BEIGE TENUE		3,5 mm	EXPERIENCE	cemento_concrete	169
BIANCO DENSO	GRES PORCELLANATO LAMINATO_LAMINATED PORCELAIN STONEWARE	3,5 mm			
BIRTH	GRES A MASSA COLORATA_COLOURED-BODY STONEWARE	9,5 mm	GENESIS Linea Fiordo	cemento_concrete	177
BLACK PRIME	RIVESTIMENTO MONOPOROSA_SINGLE-FIRED WALL TILES	9 mm	PRIME STONE	pietra_stone	127
BLACK PRIME lux	GRES A MASSA COLORATA_COLOURED-BODY STONEWARE	9,5 mm			
BLACK PRIME soft	GRES PORCELLANATO LAMINATO_LAMINATED PORCELAIN STONEWARE	5,5 mm			
BLACK PRIME strutturato	GRES A MASSA COLORATA_COLOURED-BODY STONEWARE	9,5 mm			
BONE	GRES A MASSA COLORATA_COLOURED-BODY STONEWARE	20 mm	CROSS WOOD	legno_wood	299
BREACH GREY lux	GRES PORCELLANATO LAMINATO_LAMINATED PORCELAIN STONEWARE	6 mm	ETERNITY	marmo_marble	253
	GRES A MASSA COLORATA_COLOURED-BODY STONEWARE	9,5 mm			
BREACH GREY soft	GRES PORCELLANATO LAMINATO_LAMINATED PORCELAIN STONEWARE	6 mm	ETERNITY	marmo_marble	253
	GRES A MASSA COLORATA_COLOURED-BODY STONEWARE	9,5 mm			
BUFF		9,5 mm	CROSS WOOD	legno_wood	299
BUFF ext	GRES A MASSA COLORATA_COLOURED-BODY STONEWARE	9,5 mm			
BUFF strutturato		20 mm			
C					
CALACATTA WHITE	RIVESTIMENTO MONOPOROSA_SINGLE-FIRED WALL TILES	10,5 mm	TRILOGY	marmo_marble	269
CALACATTA WHITE lux	GRES PORCELLANATO LAMINATO_LAMINATED PORCELAIN STONEWARE	5,5 mm			
	GRES A MASSA COLORATA_COLOURED-BODY STONEWARE	9,5 mm			
CALACATTA WHITE soft	GRES PORCELLANATO LAMINATO_LAMINATED PORCELAIN STONEWARE	5,5 mm			
	GRES A MASSA COLORATA_COLOURED-BODY STONEWARE	9,5 mm			
CALCE		8/9,5 mm	OPIFICIO 22/A	cemento_concrete	221
CALCE ext	GRES A MASSA COLORATA_COLOURED-BODY STONEWARE	9,5 mm			
CALCE strutturato		20 mm	NIJANCE	legno_wood	329
CARAMEL	GRES A MASSA COLORATA_COLOURED-BODY STONEWARE	9,5/12 mm			
CARAMEL strutturato		9,5/20 mm	MOTION Linea Fiordo		209
CARBON	GRES SMALTATO_GLAZED PORCELAIN STONEWARE	9,5 mm			
CEMENT	GRES PORCELLANATO LAMINATO_LAMINATED PORCELAIN STONEWARE	3,5 mm	URBANATURE	cemento_concrete	235
	CEMENT strutturato	GRES A MASSA COLORATA_COLOURED-BODY STONEWARE			
CENDRE		9,5/20 mm	NIJANCE	legno_wood	329
CENDRE strutturato	GRES A MASSA COLORATA_COLOURED-BODY STONEWARE	9,5/12 mm			
CENERE		9,5 mm	OPIFICIO 22/A	cemento_concrete	221
	CENERE ext	GRES A MASSA COLORATA_COLOURED-BODY STONEWARE			
CENERE strutturato		20 mm	ASSI D'ALPE	legno_wood	283
CHALET	GRES A MASSA COLORATA_COLOURED-BODY STONEWARE	9,5 mm			
CHARME		9,5 mm	PIERRE DES RÊVES	pietra_stone	107
CHARME ext	GRES A MASSA COLORATA_COLOURED-BODY STONEWARE	9,5 mm			
CHARME strutturato		20 mm			
CHERRY	RIVESTIMENTO MONOPOROSA_SINGLE-FIRED WALL TILES	10,5 mm	EVEN	cromatico_chromatic	355
CIASA	GRES A MASSA COLORATA_COLOURED-BODY STONEWARE	9,5 mm	ASSI D'ALPE	legno_wood	283
CINDER		9,5 mm	CROSS WOOD	legno_wood	299
CINDER ext	GRES A MASSA COLORATA_COLOURED-BODY STONEWARE	9,5 mm			
CINDER strutturato		20 mm	MOTION Linea Fiordo	cemento_concrete	209
CLEAR	GRES SMALTATO_GLAZED PORCELAIN STONEWARE	9,5 mm			
CLOUD		9,5 mm	HORIZON	pietra_stone	83
CLOUD strutturato	GRES A MASSA COLORATA_COLOURED-BODY STONEWARE	9,5/20 mm			

PRODOTTO PRODUCT PRODUKT PRODUIT	TECNOLOGIA TECHNOLOGY TECHNOLOGIE TECHNOLOGIE	SPESSORE THICKNESS STÄRKE ÉPAISSEUR	SERIE SERIES SÉRIE SÉRIE	EFFETTO LOOK OPTIK ASPECT	PAGINA PAGE SEITE PAGE
COAL	GRES A MASSA COLORATA_COLOURED-BODY STONEWARE	9,5 mm	GLANCE	cemento_concrete	185
COCO naturale	GRES A MASSA COLORATA_COLOURED-BODY STONEWARE	9,5 mm	CHIC WOOD	legno_wood	289
	GRES PORCELLANATO LAMINATO_LAMINATED PORCELAIN STONEWARE	3,5 mm			
CONCRETE		8/9,5 mm	URBANATURE	cemento_concrete	235
CONCRETE strutturato	GRES A MASSA COLORATA_COLOURED-BODY STONEWARE	9,5 mm			
COPPER	GRES A MASSA COLORATA_COLOURED-BODY STONEWARE	8/9,5 mm	MEMORY MOOD	cemento_concrete	199
CREAMY	GRES A MASSA COLORATA_COLOURED-BODY STONEWARE	8/9,5 mm			
D					
DIM		8/9,5 mm	MEMORY MOOD	cemento_concrete	199
DIM strutturato	GRES A MASSA COLORATA_COLOURED-BODY STONEWARE	20 mm			
DOVE	RIVESTIMENTO MONOPOROSA_SINGLE-FIRED WALL TILES	10,5 mm	EVEN	cromatico_chromatic	355
DROVE	GRES A MASSA COLORATA_COLOURED-BODY STONEWARE	9,5/12 mm	NORTH CAPE	legno_wood	317
DUN	GRES SMALTATO_GLAZED PORCELAIN STONEWARE	9,5 mm	MOTION Linea Fiordo	cemento_concrete	209
DUST		9,5 mm	CROSS WOOD	legno_wood	299
DUST ext	GRES A MASSA COLORATA_COLOURED-BODY STONEWARE	9,5 mm			
DUST strutturato		20 mm			
E					
EBONY		9,5 mm	CROSS WOOD	legno_wood	299
EBONY ext	GRES A MASSA COLORATA_COLOURED-BODY STONEWARE	9,5 mm			
EMBER naturale	GRES A MASSA COLORATA_COLOURED-BODY STONEWARE	9,5 mm	CHIC WOOD	legno_wood	289
F					
FABULA		10 mm	PETRA SOLIS	pietra_stone	93
FABULA strutturato	GRES A MASSA COLORATA_COLOURED-BODY STONEWARE	10/20 mm			
FLORIDA	GRES SMALTATO_GLAZED PORCELAIN STONEWARE	9,5 mm	WOOD RELIVE Linea Fiordo	legno_wood	341
FOAM naturale	GRES A MASSA COLORATA_COLOURED-BODY STONEWARE	9,5 mm	CHIC WOOD	legno_wood	289
G					
GESSO		8/9,5 mm	OPIFICIO 22/A	cemento_concrete	221
GESSO ext	GRES A MASSA COLORATA_COLOURED-BODY STONEWARE	9,5 mm			
GESSO strutturato		20 mm			
GLEN		9,5 mm	FRAME Linea Fiordo	pietra_stone	73
GLEN strutturato	GRES A MASSA COLORATA_COLOURED-BODY STONEWARE	9,5/20 mm			
GLOAM	GRES A MASSA COLORATA_COLOURED-BODY STONEWARE	9,5 mm	GENESIS Linea Fiordo	cemento_concrete	177
GREIGE PRIME	RIVESTIMENTO MONOPOROSA_SINGLE-FIRED WALL TILES	9 mm	PRIME STONE	pietra_stone	127
GREIGE PRIME lux	GRES A MASSA COLORATA_COLOURED-BODY STONEWARE	9,5 mm			
GREIGE PRIME soft	GRES PORCELLANATO LAMINATO_LAMINATED PORCELAIN STONEWARE	5,5 mm			
GREIGE PRIME strutturato	GRES A MASSA COLORATA_COLOURED-BODY STONEWARE	9,5 mm			
GRIGIO MISTO	GRES TUTTA MASSA_FULL-BODY STONEWARE	20 mm	PIETRE DI FANES	pietra_stone	114
GRIGIO VIVO	GRES PORCELLANATO LAMINATO_LAMINATED PORCELAIN STONEWARE	3,5 mm	EXPERIENCE	cemento_concrete	169
GROOVE		9,5 mm	FRAME Linea Fiordo	pietra_stone	73
GROOVE strutturato	GRES A MASSA COLORATA_COLOURED-BODY STONEWARE	9,5/20mm			
GUTULIA	GRES A MASSA COLORATA_COLOURED-BODY STONEWARE	9,5/12 mm	NORTH CAPE	legno_wood	317
H					
HANGAR naturale	GRES PORCELLANATO LAMINATO_LAMINATED PORCELAIN STONEWARE	6 mm	CONTEXT	cemento_concrete	161
HANGAR soft		9,5 mm			
HANGAR strutturato	GRES A MASSA COLORATA_COLOURED-BODY STONEWARE	9,5/20 mm			
HAZEL		8/9,5 mm	MEMORY MOOD	cemento_concrete	199
HAZEL strutturato	GRES A MASSA COLORATA_COLOURED-BODY STONEWARE	20 mm			
HONEY naturale	GRES A MASSA COLORATA_COLOURED-BODY STONEWARE	9,5 mm	CHIC WOOD	legno_wood	289
I					
IN-LIFE		9,5 mm	IN-WOOD Linea Fiordo	legno_wood	311
IN-MOOD	GRES SMALTATO_GLAZED PORCELAIN STONEWARE	9,5 mm			
IVORY	RIVESTIMENTO MONOPOROSA_SINGLE-FIRED WALL TILES	10,5 mm	EVEN	cromatico_chromatic	355
K					
KEEN	GRES A MASSA COLORATA_COLOURED-BODY STONEWARE	8/9,5 mm	MEMORY MOOD	cemento_concrete	199
L					
LAND naturale	GRES SMALTATO_GLAZED PORCELAIN STONEWARE	9,5 mm	MOTION Linea Fiordo	cemento_concrete	209
LEAF	RIVESTIMENTO MONOPOROSA_SINGLE-FIRED WALL TILES	10,5 mm	EVEN	cromatico_chromatic	355
LIME naturale	GRES A MASSA COLORATA_COLOURED-BODY STONEWARE	8/9,5 mm	URBANATURE	cemento_concrete	235
	GRES PORCELLANATO LAMINATO_LAMINATED PORCELAIN STONEWARE	3,5 mm			
LOFT naturale	GRES PORCELLANATO LAMINATO_LAMINATED PORCELAIN STONEWARE	6 mm	CONTEXT	cemento_concrete	161
		9,5 mm			
LOFT soft	GRES A MASSA COLORATA_COLOURED-BODY STONEWARE	9,5 mm			
LOFT ext		9,5 mm			
LOFT strutturato		9,5/20 mm			
M					
MANSSION naturale	GRES PORCELLANATO LAMINATO_LAMINATED PORCELAIN STONEWARE	6 mm	CONTEXT	cemento_concrete	161
MANSSION soft	GRES A MASSA COLORATA_COLOURED-BODY STONEWARE	9,5 mm			

Indice alfabetico dei prodotti

List of products in alphabetical order_Alphabetisches verzeichnis der Produkte_Index alphabétique des produits

PRODOTTO PRODUCT PRODUKT PRODUIT	TECNOLOGIA TECHNOLOGY TECHNOLOGIE TECHNOLOGIE	SPESSORE THICKNESS STÄRKE ÉPAISSEUR	SERIE SERIES SÉRIE SÉRIE	EFFETTO LOOK OPTIK ASPECT	PAGINA PAGE SEITE PAGE
MANSION ext	GRES A MASSA COLORATA_COLOURED-BODY STONEWARE	11 mm	CONTEXT	cemento_concrete	161
MANSION strutturato		20 mm			
MARQUINA BLACK lux	GRES PORCELLANATO LAMINATO_LAMINATED PORCELAIN STONEWARE	6 mm	ETERNITY	marmo_marble	253
MARQUINA BLACK soft	GRES A MASSA COLORATA_COLOURED-BODY STONEWARE	9,5 mm			
	GRES PORCELLANATO LAMINATO_LAMINATED PORCELAIN STONEWARE	6 mm			
MASO naturale	GRES A MASSA COLORATA_COLOURED-BODY STONEWARE	9,5 mm	ASSI D'ALPE	legno_wood	283
MID naturale	GRES SMALTATO_GLAZED PORCELAIN STONEWARE	9,5 mm	MOTION Linea Fiordo	cemento_concrete	209
MIEL naturale	GRES A MASSA COLORATA_COLOURED-BODY STONEWARE	9,5/12 mm	NUANCE	legno_wood	329
MIEL strutturato		9,5/20 mm			
MILK naturale	GRES A MASSA COLORATA_COLOURED-BODY STONEWARE	9,5 mm	CHIC WOOD	legno_wood	289
MIRUM naturale	GRES A MASSA COLORATA_COLOURED-BODY STONEWARE	10 mm	PETRA SOLIS	pietra_stone	93
MIRUM strutturato		10/20 mm			
MONTANA naturale	GRES SMALTATO_GLAZED PORCELAIN STONEWARE	9,5 mm	WOOD RELIVE Linea Fiordo	legno_wood	341
MOON BEIGE	RIVESTIMENTO MONOPOROSA_SINGLE-FIRED WALL TILES	10,5 mm	TRILOGY	marmo_marble	269
MOON BEIGE lux	GRES PORCELLANATO LAMINATO_LAMINATED PORCELAIN STONEWARE	5,5 mm			
	GRES A MASSA COLORATA_COLOURED-BODY STONEWARE	9,5 mm			
MOON BEIGE soft	GRES PORCELLANATO LAMINATO_LAMINATED PORCELAIN STONEWARE	5,5 mm	TRACKS Linea Fiordo	pietra_stone	147
	GRES A MASSA COLORATA_COLOURED-BODY STONEWARE	9,5 mm			
MUD naturale	GRES A MASSA COLORATA_COLOURED-BODY STONEWARE	9,5 mm	TRACKS Linea Fiordo	pietra_stone	147
MUD strutturato		8/20 mm			
N					
NERO PURO naturale	GRES PORCELLANATO LAMINATO_LAMINATED PORCELAIN STONEWARE	3,5 mm	EXPERIENCE	cemento_concrete	169
NUAGE naturale	GRES A MASSA COLORATA_COLOURED-BODY STONEWARE	9,5 mm	PIERRE DES REVES	pietra_stone	107
NUAGE ext		9,5 mm			
NUAGE strutturato		12/20 mm			
O					
OCEAN	RIVESTIMENTO MONOPOROSA_SINGLE-FIRED WALL TILES	10,5 mm	EVEN	cromatico_chromatic	355
OFF-WHITE	GRES A MASSA COLORATA_COLOURED-BODY STONEWARE	9,5 mm	GLANCE	cemento_concrete	185
ONYX LIGHT	RIVESTIMENTO MONOPOROSA_SINGLE-FIRED WALL TILES	10,5 mm	TRILOGY	marmo_marble	269
ONYX LIGHT lux	GRES PORCELLANATO LAMINATO_LAMINATED PORCELAIN STONEWARE	5,5 mm			
	GRES A MASSA COLORATA_COLOURED-BODY STONEWARE	9,5 mm			
ONYX LIGHT soft	GRES PORCELLANATO LAMINATO_LAMINATED PORCELAIN STONEWARE	5,5 mm	WOOD RELIVE Linea Fiordo	legno_wood	341
	GRES A MASSA COLORATA_COLOURED-BODY STONEWARE	9,5 mm			
OREGON naturale	GRES SMALTATO_GLAZED PORCELAIN STONEWARE	9,5 mm	DISCOVER	pietra_stone	61
ORIGIN naturale	GRES A MASSA COLORATA_COLOURED-BODY STONEWARE	8/9,5 mm	DISCOVER	pietra_stone	107
ORIGIN strutturato		8/20 mm			
OUBLI naturale	GRES A MASSA COLORATA_COLOURED-BODY STONEWARE	9,5 mm	PIERRE DES REVES	pietra_stone	107
OUBLI ext		9,5 mm			
OUBLI strutturato		12/20 mm			
P					
PALE naturale	GRES A MASSA COLORATA_COLOURED-BODY STONEWARE	9,5 mm	TRACKS Linea Fiordo	pietra_stone	147
PEAK naturale	GRES A MASSA COLORATA_COLOURED-BODY STONEWARE	9,5 mm	FRAME Linea Fiordo	pietra_stone	73
PEAK strutturato		20 mm			
PEARL naturale	GRES A MASSA COLORATA_COLOURED-BODY STONEWARE	9,5 mm	GLANCE	cemento_concrete	185
PERLE naturale	GRES A MASSA COLORATA_COLOURED-BODY STONEWARE	9,5/12 mm	NUANCE	legno_wood	329
PERLE strutturato		9,5 mm			
PLAN naturale	GRES A MASSA COLORATA_COLOURED-BODY STONEWARE	8/9,5 mm	DISCOVER	pietra_stone	61
PLAN strutturato		8 mm			
PORTLAND naturale	GRES PORCELLANATO LAMINATO_LAMINATED PORCELAIN STONEWARE	3,5 mm	URBANATURE	cemento_concrete	235
PORTLAND ext	GRES A MASSA COLORATA_COLOURED-BODY STONEWARE	8/9,5 mm			
		9,5 mm			
PORTLAND strutturato	GRES A MASSA COLORATA_COLOURED-BODY STONEWARE	9,5/20 mm			
R					
R-GOLD	GRES SMALTATO_GLAZED PORCELAIN STONEWARE	10 mm	ROCK STYLE Linea Fiordo	pietra_stone	136
R-ROYAL		10 mm			
R-SILVER		10 mm			
REISA naturale	GRES A MASSA COLORATA_COLOURED-BODY STONEWARE	9,5/12 mm	NORTH CAPE	legno_wood	317
REVEILLE naturale	GRES A MASSA COLORATA_COLOURED-BODY STONEWARE	9,5 mm	PIERRE DES REVES	pietra_stone	107
REVEILLE ext		9,5 mm			
REVEILLE strutturato		20 mm			
RIVER naturale	GRES A MASSA COLORATA_COLOURED-BODY STONEWARE	9,5 mm	FRAME Linea Fiordo	pietra_stone	73
RIVER strutturato		9,5/20 mm			
RONDANE naturale	GRES A MASSA COLORATA_COLOURED-BODY STONEWARE	9,5/12 mm	NORTH CAPE	legno_wood	317
ROOT naturale	GRES A MASSA COLORATA_COLOURED-BODY STONEWARE	9,5 mm	GENESIS Linea Fiordo	cemento_concrete	177
ROSSO MISTO strutturato	GRES TUTTA MASSA_FULL-BODY STONEWARE	9 mm	PIETRE DI FANES	pietra_stone	114
ROVERE NATURALE naturale	GRES PORCELLANATO LAMINATO_LAMINATED PORCELAIN STONEWARE	3,5 mm	DOGHE	legno_wood	306
ROVERE OLIATO naturale		3,5 mm			
ROVERE VERNICIATO naturale		3,5 mm			

PRODOTTO PRODUCT PRODUKT PRODUIT	TECNOLOGIA TECHNOLOGY TECHNOLOGIE TECHNOLOGIE	SPESSORE THICKNESS STÄRKE ÉPAISSEUR	SERIE SERIES SÉRIE SÉRIE	EFFETTO LOOK OPTIK ASPECT	PAGINA PAGE SEITE PAGE
S					
SAND PRIME	RIVESTIMENTO MONOPOROSA_SINGLE-FIRED WALL TILES	9 mm	PRIME STONE	pietra_stone	127
SAND PRIME lux	GRES A MASSA COLORATA_COLOURED-BODY STONEWARE	9,5 mm			
SAND PRIME soft	GRES PORCELLANATO LAMINATO_LAMINATED PORCELAIN STONEWARE	5,5 mm			
SAND PRIME strutturato	GRES A MASSA COLORATA_COLOURED-BODY STONEWARE	9,5 mm	TRILOGY	marmo_marble	269
SANDY GREY	RIVESTIMENTO MONOPOROSA_SINGLE-FIRED WALL TILES	10,5 mm			
SANDY GREY lux	GRES PORCELLANATO LAMINATO_LAMINATED PORCELAIN STONEWARE	5,5 mm			
SANDY GREY soft	GRES A MASSA COLORATA_COLOURED-BODY STONEWARE	9,5 mm	MEMORY MOOD	cemento_concrete	199
	GRES PORCELLANATO LAMINATO_LAMINATED PORCELAIN STONEWARE	5,5 mm			
SHEER naturale	GRES A MASSA COLORATA_COLOURED-BODY STONEWARE	8/9,5 mm	URBANATURE	cemento_concrete	235
SHEER strutturato	GRES PORCELLANATO LAMINATO_LAMINATED PORCELAIN STONEWARE	20 mm			
SILICON naturale	GRES A MASSA COLORATA_COLOURED-BODY STONEWARE	3,5 mm			
SILICON strutturato	GRES A MASSA COLORATA_COLOURED-BODY STONEWARE	8/9,5 mm	PRIME STONE	pietra_stone	127
SILVER PRIME	RIVESTIMENTO MONOPOROSA_SINGLE-FIRED WALL TILES	9 mm			
SILVER PRIME lux	GRES A MASSA COLORATA_COLOURED-BODY STONEWARE	9,5 mm			
SILVER PRIME soft	GRES PORCELLANATO LAMINATO_LAMINATED PORCELAIN STONEWARE	5,5 mm	HORIZON	pietra_stone	83
	GRES A MASSA COLORATA_COLOURED-BODY STONEWARE	9,5 mm			
SILVER PRIME strutturato	GRES A MASSA COLORATA_COLOURED-BODY STONEWARE	9,5/20 mm	TRILOGY	marmo_marble	269
SKY naturale	GRES A MASSA COLORATA_COLOURED-BODY STONEWARE	9,5 mm			
SKY SMOKE	RIVESTIMENTO MONOPOROSA_SINGLE-FIRED WALL TILES	10,5 mm			
SKY SMOKE lux	GRES PORCELLANATO LAMINATO_LAMINATED PORCELAIN STONEWARE	5,5 mm	GLANCE	cemento_concrete	185
	GRES A MASSA COLORATA_COLOURED-BODY STONEWARE	9,5 mm			
SKY SMOKE soft	GRES PORCELLANATO LAMINATO_LAMINATED PORCELAIN STONEWARE	5,5 mm	EVEN	cromatico_chromatic	355
	GRES A MASSA COLORATA_COLOURED-BODY STONEWARE	9,5 mm			
SNOKE naturale	GRES A MASSA COLORATA_COLOURED-BODY STONEWARE	9,5 mm	TRACKS Linea Fiordo	pietra_stone	147
SNOW	RIVESTIMENTO MONOPOROSA_SINGLE-FIRED WALL TILES	10,5 mm			
SOIL naturale	GRES A MASSA COLORATA_COLOURED-BODY STONEWARE	9,5 mm	PETRA SOLIS	pietra_stone	93
SOIL strutturato		8/20 mm			
SOMNIUM naturale	GRES A MASSA COLORATA_COLOURED-BODY STONEWARE	10 mm	GENESIS Linea Fiordo	pietra_stone	177
SOMNIUM strutturato	GRES A MASSA COLORATA_COLOURED-BODY STONEWARE	10/20 mm			
SOUL naturale	GRES A MASSA COLORATA_COLOURED-BODY STONEWARE	9,5 mm	CONTEXT	cemento_concrete	161
SQUARE naturale	GRES PORCELLANATO LAMINATO_LAMINATED PORCELAIN STONEWARE	6 mm			
	GRES A MASSA COLORATA_COLOURED-BODY STONEWARE	9,5 mm			
SQUARE soft	GRES A MASSA COLORATA_COLOURED-BODY STONEWARE	9,5 mm	ETERNITY	marmo_marble	253
SQUARE ext		9,5 mm			
SQUARE strutturato		9,5/20 mm			
STATUARIO WHITE lux	GRES PORCELLANATO LAMINATO_LAMINATED PORCELAIN STONEWARE	6 mm	CONTEXT	cemento_concrete	161
	GRES A MASSA COLORATA_COLOURED-BODY STONEWARE	9,5 mm			
STATUARIO WHITE soft	GRES PORCELLANATO LAMINATO_LAMINATED PORCELAIN STONEWARE	6 mm	HORIZON	pietra_stone	83
	GRES A MASSA COLORATA_COLOURED-BODY STONEWARE	9,5 mm			
STORE naturale	GRES PORCELLANATO LAMINATO_LAMINATED PORCELAIN STONEWARE	6 mm	ASSI D'ALPE	legno_wood	283
	GRES A MASSA COLORATA_COLOURED-BODY STONEWARE	9,5 mm			
STORE soft	GRES A MASSA COLORATA_COLOURED-BODY STONEWARE	9,5 mm	DISCOVER	pietra_stone	61
STORE strutturato		9,5/20 mm			
STORM naturale	GRES A MASSA COLORATA_COLOURED-BODY STONEWARE	9,5 mm	HORIZON	pietra_stone	83
STORM strutturato		9,5/20 mm			
STUBE naturale	GRES A MASSA COLORATA_COLOURED-BODY STONEWARE	9,5 mm	ASSI D'ALPE	legno_wood	283
SUN naturale	GRES A MASSA COLORATA_COLOURED-BODY STONEWARE	8/9,5 mm	DISCOVER	pietra_stone	61
SUN strutturato		8/20 mm			
SUNRISE naturale		9,5 mm			
SUNRISE strutturato	GRES A MASSA COLORATA_COLOURED-BODY STONEWARE	9,5/20 mm	HORIZON	pietra_stone	83
SUNSET naturale		9,5 mm			
SUNSET strutturato		9,5/20 mm			
T					
TABAC naturale	GRES A MASSA COLORATA_COLOURED-BODY STONEWARE	9,5/12 mm	NUANCE	legno_wood	329
TABAC strutturato	GRES A MASSA COLORATA_COLOURED-BODY STONEWARE	9,5/20 mm	GLANCE	cemento_concrete	185
TAUPE naturale	GRES A MASSA COLORATA_COLOURED-BODY STONEWARE	9,5 mm			
TERRA naturale	GRES A MASSA COLORATA_COLOURED-BODY STONEWARE	8/9,5 mm	OPIFICIO 22/A	cemento_concrete	221
TERRA ext		9,5 mm			
TERRA strutturato		20 mm			
W					
WHITE naturale	GRES A MASSA COLORATA_COLOURED-BODY STONEWARE	8/9,5 mm	DISCOVER	pietra_stone	61
WHITE strutturato		8/20 mm			
WHITE PRIME	RIVESTIMENTO MONOPOROSA_SINGLE-FIRED WALL TILES	9 mm	PRIME STONE	pietra_stone	127
WHITE PRIME lux	GRES A MASSA COLORATA_COLOURED-BODY STONEWARE	9,5 mm			
WHITE PRIME soft	GRES PORCELLANATO LAMINATO_LAMINATED PORCELAIN STONEWARE	5,5 mm			
WHITE PRIME strutturato	GRES A MASSA COLORATA_COLOURED-BODY STONEWARE	9,5 mm			

Condizioni generali di vendita

General terms and conditions of sale

1) Ambito di applicazione

1.1 Le presenti condizioni generali di vendita ("CGV") si applicheranno a tutte le forniture di piastrelle in ceramica o altri prodotti in ceramica ("Prodotti") che saranno eseguite nei confronti di qualsiasi cliente ("CLIENTE") da una società o divisione del Gruppo Panariagroup Industrie Ceramiche S.p.A. ("VENDITORE") anche se le CGV non verranno di volta in volta espressamente richiamate, menzionate ovvero espressamente accettate dal CLIENTE.

1.2 Accordi in deroga alle presenti CGV saranno efficaci nei confronti di VENDITORE soltanto (i) se contenuti nel "Contratto di Vendita", come definito al successivo paragrafo 3.2, (ii) se contenuti in documenti successivi alla conclusione del Contratto di Vendita ed il cui contenuto sia stato accettato per iscritto da VENDITORE. In ogni caso, anche se presenti deroghe concordate per iscritto, le CGV continueranno ad applicarsi per le parti non espressamente derogate.

1.3 In nessun caso VENDITORE sarà vincolato da eventuali condizioni generali di contratto di CLIENTE, neanche qualora esse siano richiamate o riportate negli ordini o in qualsiasi altra documentazione trasmessa a VENDITORE da CLIENTE. Nessun comportamento di VENDITORE potrà essere interpretato o utilizzato al fine di esprimere tacita accettazione di VENDITORE delle condizioni generali di contratto di CLIENTE.

1.4 In nessun caso, VENDITORE sarà vincolato da atti e/o azioni dei propri agenti, essendo questi ultimi privi del potere di vincolare il VENDITORE.

1.5 Nel caso in cui CLIENTE sia un consumatore, le disposizioni delle presenti CGV non pregiudicheranno i diritti allo stesso spettanti in base alle previsioni di legge relative alle vendite eseguite nei confronti dei consumatori.

2) Prodotti – Modifiche

2.1 Le rappresentazioni e/o immagini riguardanti i Prodotti riportate in siti internet, brochure, cataloghi, listini prezzi o documenti similari di VENDITORE hanno valore indicativo ed illustrativo. Conseguentemente, esse non rappresentano il risultato estetico finale dei Prodotti. Le caratteristiche tecniche e fisiche nonché le qualità dei Prodotti sono riportate unicamente nei manuali tecnici di VENDITORE. Ogni altro documento riportante le caratteristiche tecniche e fisiche nonché le qualità dei Prodotti ha valore puramente indicativo e non sarà vincolante per VENDITORE.

2.2 VENDITORE dichiara che i Prodotti sono conformi alle norme italiane e comunitarie di settore ad essi applicabili. A pena di inefficacia della garanzia di cui all'articolo 7 e di qualsiasi altra garanzia convenzionale e/o legale, ciascun Prodotto dovrà essere utilizzato ed applicato in conformità alle indicazioni di utilizzo di VENDITORE riferite ai Prodotti in questione e riportate nei cataloghi e/o nei manuali tecnici di VENDITORE ovvero diversamente comunicate o rese accessibili da VENDITORE a CLIENTE e, comunque, in conformità alla diligenza richiesta dalla natura dei Prodotti stessi.

2.3 È responsabilità di CLIENTE, prima della conclusione del Contratto di Vendita, accertare che i Prodotti siano idonei allo scopo e/o all'uso specifico per il quale intende acquistarli e, inoltre, accertare che i Prodotti medesimi siano conformi alla normativa applicabile nel luogo in cui CLIENTE intende importarli, distribuirli, venderli o farne qualsiasi uso.

2.4 VENDITORE, anche dopo la conclusione del Contratto di Vendita, potrà apportare ai Prodotti qualsiasi modifica che esso ritenga necessaria o opportuna, purché non ne alteri le caratteristiche essenziali. Qualora VENDITORE esegua modifiche sostanziali ai Prodotti (ad es. modifiche che interessano: le modalità di installazione, le caratteristiche di intercambiabilità dei Prodotti ecc.) oggetto di un Contratto di Vendita (come definito al successivo paragrafo 3.2), VENDITORE comunicherà per iscritto tale modifica a CLIENTE.

2.5 CLIENTE sarà tenuto a rappresentare agli acquirenti dei Prodotti e ai terzi le caratteristiche dei Prodotti nonché le indicazioni d'uso e di applicazione degli stessi, in conformità a quanto rappresentatogli da VENDITORE. Fermo restando quanto sopra, CLIENTE sarà esclusivamente responsabile per le dichiarazioni effettuate nei confronti dei terzi in relazione ai Prodotti, alle loro caratteristiche e al loro uso e/o applicazione e dovrà tenere VENDITORE indenne e manlevato da qualsiasi danno eventualmente subito da VENDITORE in relazione a o in connessione con tali dichiarazioni di CLIENTE, nel caso in cui le stesse siano false, incomplete e/o inesatte.

3) Preventivi – Conclusione del Contratto di Vendita - Tolleranze

3.1 I preventivi, verbali o scritti, di VENDITORE non costituiscono proposte contrattuali.

3.2 Il contratto di vendita ("Contratto di Vendita") si perfezionerà attraverso:

- la trasmissione della offerta da parte di VENDITORE e l'accettazione scritta di tale offerta da parte di CLIENTE senza alcuna modifica all'offerta stessa; oppure
- la trasmissione dell'ordine da parte di CLIENTE e l'accettazione scritta di tale ordine da parte di VENDITORE.

3.3 Ai fini del precedente paragrafo 3.2, lettera a) i seguenti fatti o atti avranno valore di accettazione scritta della offerta di VENDITORE da parte di CLIENTE:

- ricezione e accettazione, da parte di VENDITORE, di una lettera di credito procurata da CLIENTE;
 - ricezione e accettazione, da parte di VENDITORE, di tutto o di parte del prezzo della fornitura;
 - ricezione, da parte di VENDITORE, di un ordine di acquisto emesso da CLIENTE.
- In tal caso, qualsiasi previsione dell'ordine di acquisto di CLIENTE che risulti difforme dalle previsioni della offerta di VENDITORE sarà vincolante nei confronti di VENDITORE solo se specificamente accettata per iscritto da quest'ultimo.
- 3.4 Inoltre, ai fini del precedente paragrafo 3.2, lettera b), nel caso in cui la accettazione di VENDITORE dell'ordine di CLIENTE contenga condizioni differenti rispetto all'ordine formulato da CLIENTE, il Contratto di Vendita si considererà concluso alle condizioni riportate nella conferma d'ordine di VENDITORE, salvo il caso in cui CLIENTE comunichi per iscritto di rifiutare le modifiche riportate nella accettazione dell'ordine di VENDITORE entro 1 (uno) giorno lavorativo dalla ricezione della stessa.

3.5 Le forniture comprenderanno esclusivamente quanto indicato nel Contratto di Vendita.

3.6 CLIENTE riconosce a VENDITORE i margini di tolleranza quantitativa e/o qualitativa rinvenibili dal Contratto di Vendita o dagli usi o dalla prassi del settore dei Prodotti.

4) Imballaggio – Termini di resa – Termini di consegna

4.1 I Prodotti saranno imballati ed approntati per la spedizione secondo i sistemi di protezione generalmente adottati da VENDITORE per i Prodotti in questione in considerazione delle modalità di trasporto convenute. Qualora CLIENTE ritenga necessario l'impiego di imballaggi speciali o di protezioni aggiuntive dovrà farne espressa richiesta a VENDITORE, fermo restando che, in tal caso, saranno a carico di CLIENTE tutti i relativi costi.

4.2 Salvo diversamente previsto nel Contratto di Vendita, i Prodotti saranno consegnati a CLIENTE in conformità alla regola Incoterms® ICC, ultima versione, Ex-Works (EXW) – stabilimento di VENDITORE indicato nel Contratto di Vendita.

CLIENTE autorizza VENDITORE a sottoscrivere, in nome e per conto di CLIENTE, tutti i documenti che debbano essere sottoscritti al momento della presa in carico dei Prodotti presso gli stabilimenti di VENDITORE, come, ad esempio, il CMR.

Nel caso in cui la regola Incoterms® ICC concordata tra le parti preveda che CLIENTE debba curare il trasporto dei Prodotti fuori dall'Italia:

a) in caso di cessione intra-comunitaria, entro 45 (quarantacinque) giorni dalla ricezione dei Prodotti presso gli stabilimenti di CLIENTE, CLIENTE dovrà trasmettere a VENDITORE un originale o una copia del documento di trasporto internazionale CMR o di altro documento di trasporto, sottoscritto a destinazione da CLIENTE ovvero, in assenza del CMR, una dichiarazione di ricezione dei Prodotti, emessa sulla base del form quale Allegato -1- disponibile per il download all'indirizzo www.panariagroup.it;

b) in caso di cessione extra-comunitaria, CLIENTE si impegna a:

i) presentare la dichiarazione doganale di esportazione (DAU-EX e DAE) ed effettuare l'appuntamento del MRN (Movement Reference Number) presso la dogana del territorio comunitario di uscita dei Prodotti, entro 90 (novanta) giorni dalla data di consegna in Italia dei Prodotti stessi;

ii) inviare a VENDITORE, entro 90 (novanta) giorni dalla data di consegna, i documenti comprovanti l'esportazione dei Prodotti (dichiarazione di esportazione DAU-EX + DAE + notifica di avvenuta esportazione);

iii) confermare prontamente per iscritto a VENDITORE l'avvenuta esecuzione delle suddette formalità e a fornirgli ogni ulteriore documento comprovante l'esecuzione delle suddette formalità e l'uscita dei Prodotti dal territorio dell'Unione Europea.

In caso di inadempienza di CLIENTE a quanto pattuito al presente paragrafo 4.2, VENDITORE avrà il diritto di addebitare immediatamente a CLIENTE l'imposta sul Valore Aggiunto relativa alla fornitura e connessa alla mancata prova del trasporto dei Prodotti in altro Stato Membro della Comunità Europea o mancato appuramento della esportazione. In ogni caso, CLIENTE terrà indenne e manlevato VENDITORE in relazione al pagamento di tutto quanto eventualmente dovuto da VENDITORE nei confronti dell'Amministrazione Finanziaria, a titolo di sanzioni ed interessi o ad altro titolo, in connessione con la fornitura e la mancata prova del trasporto dei Prodotti in altro Stato Membro della Comunità Europea o al mancato appuramento della esportazione.

A tal proposito, VENDITORE potrà: (i) compensare qualsiasi importo dovuto da CLIENTE in base al presente paragrafo 4.2 con eventuali crediti maturati da CLIENTE, a qualsiasi titolo, nei confronti di VENDITORE; ovvero (ii) trattenerne definitivamente eventuali somme già ricevute da CLIENTE in relazione a Contratti di Vendita ancora da eseguirsi, effettuando una compensazione fra il debito di CLIENTE in base al presente paragrafo 4.2 e tutti i pagamenti già eseguiti da CLIENTE.

4.3 VENDITORE eseguirà la consegna dei Prodotti entro il termine previsto nel Contratto di Vendita, anche mediante consegne parziali. Il termine di consegna si intenderà in ogni caso non essenziale né perentorio. Salvo il caso di dolo o colpa grave, VENDITORE non sarà tenuto a corrispondere a CLIENTE alcun indennizzo o risarcimento per eventuali danni diretti o indiretti dovuti al ritardo nella consegna. In nessun caso di ritardo nella consegna dei Prodotti CLIENTE avrà il diritto di risolvere il Contratto di Vendita.

4.4 Al momento della ricezione dei Prodotti, CLIENTE avrà l'onere di denunciare danneggiamenti agli imballi e/o eventuali avarie o ammanchi di Prodotti verificatisi durante il trasporto, mediante apposizione di riserva scritta nel documento di trasporto, nonché l'onere di:

- far confermare dal vettore, mediate apposita sottoscrizione, l'apposizione della riserva; e
 - informare immediatamente per iscritto VENDITORE e inviargli copia del suddetto documento entro e non oltre 8 (otto) giorni dalla data di ricezione dei Prodotti.
- In caso contrario, VENDITORE non sarà responsabile per eventuali danneggiamenti, perdite o furti occorsi ai Prodotti durante il trasporto, anche qualora lo stesso sia eseguito con rischio in tutto o in parte a carico di VENDITORE.

5) Prezzi – Pagamento – Ritardato pagamento

5.1 I Prodotti verranno forniti ai prezzi concordati tra le parti nel Contratto di Vendita o, qualora il Contratto di Vendita non dovesse menzionare alcun prezzo, ai prezzi riportati nel listino prezzi di VENDITORE in vigore al momento della conclusione del Contratto di Vendita. Salvo diversa indicazione scritta, i prezzi dei Prodotti riportati nei listini, nei preventivi e/o nelle offerte di VENDITORE si intendono in Euro, al netto di IVA e per consegne eseguite in conformità alla regola Incoterms® Ex-Works (EXW), stabilimento di VENDITORE indicato nel Contratto di Vendita, ICC, ultima versione. Pertanto, nel caso in cui venga convenuto un diverso termine di resa, l'importo della fattura verrà modificato di conseguenza, includendo in fattura le spese di trasporto e ogni altro onere connesso con il termine di resa concordato tra le parti per la consegna dei Prodotti.

5.2 Il pagamento dei Prodotti dovrà essere eseguito da CLIENTE con le modalità e nei tempi indicati nel Contratto di Vendita o diversamente concordati per iscritto tra le parti. I pagamenti si considereranno effettuati da CLIENTE solo nel momento in cui il relativo importo sarà stato accreditato sul conto corrente di VENDITORE. Il pagamento dovrà essere effettuato da CLIENTE in Euro ovvero nella valuta del luogo in cui CLIENTE ha la propria sede, a scelta di VENDITORE, in conformità alla valuta che VENDITORE indicherà nella relativa fattura di vendita.

5.3 Nel caso in cui CLIENTE sia in ritardo nell'esecuzione del pagamento, VENDITORE avrà diritto:

- al pagamento degli interessi legali di mora, in conformità alla legge applicabile;
- b) di sospendere le consegne ancora da eseguirsi, previa comunicazione scritta a CLIENTE, fino a quando gli importi dovuti e i relativi interessi di mora siano stati integralmente pagati.

5.4 Qualora tali importi e interessi risultino ancora non pagati una volta decorsi 30 (trenta) giorni dalla scadenza data di pagamento concordata, VENDITORE potrà altresì, a propria discrezione, alternativamente o cumulativamente, e in aggiunta a qualsiasi altro diritto o rimedio allo stesso spettante in base alla legge o alle presenti CGV:

a) esigere l'immediato pagamento di ogni debito residuo, anche se sia stato convenuto un pagamento a rate o un pagamento dilazionato e/o siano stati emessi e siano in scadenza cambiali tratte, pagherò cambiari, assegni o altri strumenti di pagamento;

b) risolvere il Contratto di Vendita in questione e trattenerne definitivamente eventuali somme già ricevute in relazione a tale Contratto di Vendita e/o ad altri Contratti di Vendita, effettuando una compensazione fra il debito di CLIENTE e tutti i pagamenti ricevuti;

c) eseguire le future consegne dei Prodotti soltanto previo pagamento anticipato in relazione alle forniture ancora da eseguirsi;

d) revocare sconti e bonus che siano stati concordati fra le parti anche in relazione a Contratti di Vendita regolarmente eseguiti.

5.5 I diritti di cui ai precedenti paragrafi 5.3 e 5.4 potranno essere esercitati in qualsiasi momento da VENDITORE anche nel caso in cui:

- CLIENTE sia sottoposto a liquidazione, a procedure concorsuali, fallimentari, di ristrutturazione del debito o ad azioni esecutive; oppure
- b) la compagnia assicurativa di VENDITORE rifiuti la copertura assicurativa di crediti di VENDITORE nei confronti di CLIENTE; oppure
- c) CLIENTE versi in uno stato di difficoltà finanziaria - idoneo a determinare un pregiudizio al puntuale adempimento dei propri obblighi di pagamento - risultante, a titolo esemplificativo e non esaustivo, dalla levata di protesti, dalla diminuzione di garanzie concesse e/o dalla mancata prestazione di garanzie promesse, nonché dal verificarsi di qualsiasi insoluto, anche qualora tali circostanze si siano verificate nell'ambito dei rapporti tra CLIENTE ed altri suoi fornitori.

5.6 CLIENTE non potrà far valere eventuali inadempimenti di VENDITORE né potrà avviare alcuna azione legale nei confronti dello stesso fino a quando non abbia pagato integralmente a VENDITORE ogni importo allo stesso spettante ai sensi dei paragrafi 5.3 e 5.4.

6) Riserva di Proprietà

6.1 VENDITORE manterrà la proprietà dei Prodotti venduti fino al completo pagamento del loro prezzo da parte di CLIENTE.

Fermo restando quanto sopra, il rischio di perimento dei Prodotti sarà disciplinato dai termini di resa Incoterms® concordato tra le parti per la consegna dei Prodotti.

6.2 In caso di inadempimento o ritardo nell'adempimento dell'obbligazione di pagare il prezzo dei Prodotti, fermo restando quanto previsto ai precedenti paragrafi 5.4, 5.5 e 5.6, VENDITORE avrà il diritto di accedere ai locali in cui si trovano i Prodotti, di rientrare in possesso e di incamerare definitivamente, a titolo di penale, eventuali somme pagate da CLIENTE per i Prodotti in questione.

7) Garanzia

7.1 Fatto salvo quanto previsto ai precedenti paragrafi 2.1, 2.2, 2.4 e 3.6 in relazione alle modifiche ammesse ai Prodotti e alle tolleranze, VENDITORE garantisce a CLIENTE che i Prodotti saranno conformi al Contratto di Vendita, alla classificazione indicata nei manuali tecnici, cataloghi e/o listini prezzi di VENDITORE nonché privi di difetti di fabbricazione. La presente garanzia avrà la durata di 12 (dodici) mesi dalla data di ritiro dei Prodotti dallo stabilimento di VENDITORE, a prescindere dal termine di resa Incoterms® concordato.

7.2 Sono esclusi da qualsiasi garanzia:

- le alterazioni cromatiche e le differenze di tonalità dei Prodotti;
- b) i Prodotti classificati nel Contratto di Vendita come di qualità inferiore alla prima scelta ovvero come partite di Prodotti di fine serie venduta in blocco ovvero come partite speciali;
- c) i Prodotti non posati a regola d'arte e/o posati in modo difforme rispetto alle previsioni delle norme di settore applicabili;
- d) i Prodotti applicati su superfici e/o in ambienti diversi da quelli consigliati da VENDITORE;
- e) i Prodotti utilizzati in modo difforme rispetto alle istruzioni e/o indicazioni di VENDITORE incluse nei cataloghi e/o i listini di VENDITORE ovvero in altro modo comunicate a CLIENTE da VENDITORE ivi incluse le indicazioni di cui al precedente paragrafo 2.2;
- f) i Prodotti utilizzati in modo non conforme alla normale diligenza e/o alla tecnica richieste dalla natura dei Prodotti stessi;
- g) l'ingelività del Prodotto, a meno che tale caratteristica del Prodotto non sia stata dichiarata da VENDITORE nel manuale tecnico, in riferimento al Prodotto in questione;
- h) caratteristiche dei Prodotti come risultanti dalla classificazione del materiale ceramico (i) eseguita da parte di organismi di controllo e/o certificazione diversi da quelli di Paesi dell'Unione Europea e/o (ii) effettuata sulla base di criteri che non corrispondano a quelli utilizzati da VENDITORE.

7.3 Fermo quanto previsto al precedente paragrafo 4.4, CLIENTE sarà tenuto ad esaminare i Prodotti nel più breve tempo possibile e, a pena di decadenza dalla presente garanzia, a denunciare per iscritto a VENDITORE, a mezzo fax o email:

- a) difformità relative alla tipologia e/o alla quantità dei Prodotti ricevuti nonché altre difformità palesi dei Prodotti o loro difetti palesi: entro e non oltre 8 (otto) giorni dalla consegna dei Prodotti e, comunque, prima della posa in opera dei Prodotti;
 - b) difformità occulte o difetti occultati dei Prodotti: entro e non oltre 8 (otto) giorni dalla scoperta e, comunque, entro il periodo di garanzia.
- 7.4 VENDITORE avrà il diritto di verificare i Prodotti, o alcuni campioni dei Prodotti, che CLIENTE ritenga essere difformi o difettosi, anche al fine di verificare il rispetto delle prescrizioni relative alla posa in opera degli stessi e/o all'applicazione e/o all'utilizzo dei Prodotti come rinvenibili dalle presenti CGV. A tale proposito, CLIENTE potrà restituire a VENDITORE i Prodotti dallo stesso ritenuti difformi o difettosi soltanto previa autorizzazione scritta di VENDITORE ed a condizione che CLIENTE si faccia integralmente carico delle spese e dei rischi di spedizione. L'autorizzazione al reso dei Prodotti o dei campioni asseritamente difformi o difettosi non costituirà in nessun caso riconoscimento delle difformità o dei difetti da parte di VENDITORE.

7.5 Nel caso in cui i Prodotti siano riconosciuti da VENDITORE come effettivamente

difformi o difettosi, CLIENTE, a scelta di VENDITORE, avrà esclusivamente diritto:

- a) alla sostituzione gratuita dei Prodotti difformi o difettosi; oppure
- b) all'esenzione parziale o totale dal pagamento del loro prezzo, a seconda della gravità delle difformità o dei difetti.

7.6 Ai fini del paragrafo 7.5 lettera (a), i Prodotti che debbano essere consegnati in sostituzione di Prodotti difformi o difettosi saranno consegnati a CLIENTE in conformità alla regola Incoterms® 2010 ICC DDP – stabilimento di CLIENTE. I Prodotti che siano stati sostituiti dovranno essere, a scelta di VENDITORE, distrutti o smaltiti da CLIENTE, a spese di quest'ultimo, ovvero restituiti a VENDITORE, a spese di VENDITORE stesso. Per i Prodotti sostituiti che debbano essere distrutti o smaltiti da CLIENTE, CLIENTE si impegna ad inviare a VENDITORE la prova dell'avvenuta distruzione o smaltimento dei Prodotti, unitamente ai documenti giustificativi comprovanti il sostenimento dei costi di distruzione o smaltimento.

7.7 I diritti e rimedi descritti ai precedenti paragrafi 7.5 e 7.6 costituiscono i soli diritti e rimedi in garanzia concessi a CLIENTE. Nella massima misura consentita dalla legge, sono esclusi ulteriori responsabilità o obblighi di VENDITORE in relazione alla fornitura di Prodotti difformi o difettosi, ivi inclusi, a titolo esemplificativo e non esaustivo, responsabilità e obblighi per eventuali danni diretti, indiretti o consequenziali, perdite di profitto, ecc. a cui tale responsabilità si ricollega.

7.8 La presente garanzia sostituisce ed esclude ogni altra garanzia, espressa o implicita, prevista per legge o altrimenti.

8) Forza maggiore

8.1 VENDITORE non sarà in alcun modo responsabile per il mancato o ritardato adempimento di alcuna obbligazione relativa alla fornitura dei Prodotti qualora tale mancato o ritardato adempimento sia dovuto a eventi di forza maggiore come guerre, incendi, terremoti, inondazioni, tsunami, scioperi, difficoltà insorte con la forza lavoro, scarsità o difficoltà di approvvigionamento di materie prime, restrizioni all'uso di energia, sospensione o difficoltà nei trasporti, guasti agli impianti, atti della pubblica autorità o a qualsiasi altra azione o causa che non possa essere ragionevolmente prevista o alla quale VENDITORE non possa ragionevolmente porre rimedio tramite l'ordinaria diligenza.

8.2 In tali eventualità, il termine per l'esecuzione della fornitura verrà esteso per tutto il periodo di durata dell'evento di forza maggiore, fermo restando che, qualora tale evento dovesse impedire l'esecuzione della fornitura per oltre 6 (sei) mesi, CLIENTE avrà il diritto di risolvere il relativo contratto di vendita, mediante invio di lettera raccomandata con ricevuta di ritorno o corriere a VENDITORE, senza alcuna responsabilità o conseguenza per VENDITORE.

9) Invalidità di singole clausole contrattuali

L'invalidità di una disposizione delle presenti CGV non comprometterà la validità delle residue disposizioni che rimarranno pienamente valide e efficaci.

10) Riservatezza

10.1 CLIENTE si impegna a: (i) trattare come riservati tutte le informazioni/dati/disegni/know-how/documentazione trasmessigli da VENDITORE ovvero di cui sia venuto a conoscenza nell'esecuzione dei singoli Contratti di Vendita, indipendentemente dal fatto che tali informazioni siano o meno contrassegnate o identificate come riservate o confidenziali ("Informazioni Riservate"); (ii) non divulgare e non comunicare a terzi, né in tutto né in parte, le Informazioni Riservate senza il preventivo consenso scritto di VENDITORE; (iii) limitare l'utilizzo di tali Informazioni Riservate ed il relativo accesso per scopi relativi all'esecuzione dei singoli Contratti di Vendita; (iv) adottare tutte le misure necessarie al fine di assicurare che i propri dipendenti e i propri collaboratori evitino di divulgare a terzi le Informazioni Riservate o le utilizzino in modo improprio. Le Informazioni Riservate non potranno essere riprodotte senza previo consenso scritto di VENDITORE, e tutte le copie delle stesse saranno immediatamente restituite dietro richiesta di VENDITORE.

10.2 Le previsioni di cui sopra non si applicano alle informazioni che: (i) sono pubbliche o divengono pubbliche non per divulgazione da parte del CLIENTE, dei suoi dipendenti o collaboratori, o (ii) erano in possesso del CLIENTE prima che le ricevesse da VENDITORE o (iii) sono state divulgate da fonti che non sono sottoposte alle restrizioni cui è sottoposto CLIENTE relativamente al loro utilizzo, o (iv) possono essere divulgate a terzi in base ad un'autorizzazione scritta di VENDITORE.

11) Legge applicabile - Risoluzione delle controversie

11.1 Le presenti CGV e tutti i Contratti di Vendita che le parti stipuleranno in base alle presenti CGV saranno regolati dalla Convenzione di Vienna del 1980 sulla vendita internazionale di merci e, nelle materie non coperte da tale Convenzione, dalla legge italiana.

11.2 Qualsiasi controversia relativa alle presenti CGV e/o ai Contratti di Vendita che interverranno sulla base delle stesse sarà decisa in conformità alle seguenti previsioni:

a) qualora CLIENTE abbia la sua sede legale nell'Unione Europea, in Svizzera, in Norvegia o in Islanda, la controversia sarà assoggettata in via esclusiva alla giurisdizione italiana e, in relazione ad essa, sarà esclusivamente competente il Tribunale di Modena (Italia);

b) in tutti gli altri casi, la controversia sarà decisa in via esclusiva e definitiva mediante arbitrato, celebrato da un arbitro unico, in conformità al Regolamento di Procedura della Camera Arbitrale di Milano.

L'arbitrato avrà sede, e il lodo arbitrale verrà pronunciato, nella città di Milano (Italia). La lingua dell'arbitrato sarà la lingua inglese.

11.3 È tuttavia concesso, unicamente a favore di VENDITORE, il diritto incondizionato di agire, in qualità di attore, sotto la giurisdizione di CLIENTE innanzi al tribunale competente.

12) Lingua delle CGV

12.1 Il testo delle presenti CGV è redatto sia in lingua italiana che in lingua inglese. In caso di discrepanza, il testo in lingua italiana prevarrà sul testo in lingua inglese.

Le presenti condizioni generali di vendita sono pubblicate e scaricabili sul sito internet www.panariagroup.it

Condizioni generali di vendita

General terms and conditions of sale

1) Scope Of Application

1.1 These General Terms and Conditions of Sale ("General Conditions") shall apply to any and all supply of ceramic tiles or other ceramic products ("Products") that will be executed to any client ("CLIENT") from any company or division of the Group Panariagroup Industrie Ceramiche S.p.A. ("SELLER"), even if these General Conditions are not expressly referred to, mentioned or expressly accepted by the CLIENT from time to time.

1.2 No provisions deviating from these General Conditions shall be binding on SELLER unless (i) included in the "Sale Contract", as defined under paragraph 3.2 below, (ii) included in documents following the Sale Contract and the content of the same has been accepted in writing by SELLER. In any case, even if deviating provisions are agreed upon, these General Conditions shall apply for the parts not expressly disregarded.

1.3 In no case shall any general conditions of contract of CLIENT be binding on SELLER, even if mentioned or included in orders or in any other documents transmitted by CLIENT to SELLER. No conduct of SELLER shall be interpreted or used in order to express tacit acceptance of SELLER to the general conditions of contract of CLIENT.

1.4 In no case SELLER shall be bound by acts and/or conducts of its agents, being the latter in lack of any power to bind SELLER.

1.5 In case CLIENT is a consumer, the provisions of these General Conditions shall not prejudice the rights of CLIENT provided for by the law applicable to sales executed toward consumers.

2) Products – Modifications

2.1 Any representation and/or image relating to the Products included in websites, brochures, catalogues, price lists or other similar documents of SELLER is approximate and purely illustrative. As a consequence, such representations and/or images do not represent the final aesthetic result of the Products. Technical and physical characteristics of the Products as well as qualities of the same are described in the technical manuals of SELLER only. Any other document including technical and physical characteristics and qualities of the Products are purely indicative and shall not bind SELLER.

2.2 SELLER declares that the Products are compliant with the applicable Italian and European industry standards. Any Products shall be used and applied in accordance with the instructions of use of SELLER included in catalogues and/or technical manuals of SELLER with reference to the Products in question or with the instructions in other way communicated and/or made available by SELLER to CLIENT and, in any case, in accordance with the diligence required by the nature of the Products. Failing to do so, CLIENT will result in the lapse of the warranty and in the unenforceability of the warranty rights under article 7 below or of any other legal or agreed warranty.

2.3 It is the responsibility of CLIENT, before executing of the Sale Contract, to make sure that the Products are suitable for their specific purpose and/or intended use and, in addition, that they also comply with the laws and regulations applicable in the place where CLIENT will import, distribute, sell or use them in any way.

2.4 SELLER may make any changes to the Products which, without altering their essential features, it deems necessary or convenient, even after execution of the Sale Contract. In case SELLER executes substantial modification to Products (e.g. modifications that will alter: the way of installation, characteristic of interchangeability of the Products, etc.) which are the object of an executed Sale Contract (as defined in paragraph 3.2 below), SELLER shall communicate in writing such modification to CLIENT.

2.5 CLIENT shall inform the purchasers of the Products and third parties of the characteristics of the Products and of the instructions of use and of application of the same in accordance with the indication provided by SELLER. Without prejudice to the above, CLIENT shall be the sole responsible and liable for the declarations it will make toward third parties with reference to the Products, their characteristics and their use or application and shall indemnify and hold SELLER harmless and from any damage possibly suffered by SELLER with reference to or in connection to such declarations of CLIENT, in case they result false, incomplete or inaccurate.

3) Quotations – Execution of Sale Contract – Tolerances

3.1 Written or verbal quotations issued by SELLER are not to be taken as valid contractual proposals.

3.2 The sale contract ("Sale Contract") is executed as follows:

a) an offer is sent by SELLER to CLIENT and CLIENT then sends its written acceptance of such offer to SELLER, without any modification to the offer itself; or
b) a purchase order is sent by CLIENT and SELLER then sends its written acceptance of such order to CLIENT.

3.3 For the purposes of paragraph 3.2 letter a) above, the following facts or actions shall constitute the written acceptance of an offer of SELLER by CLIENT:

a) the receipt by SELLER of a letter of credit sent by CLIENT;
b) the receipt by SELLER of all or part of the relevant purchase price;
c) the receipt by SELLER of a purchase order of CLIENT. Should this be the case, any order of CLIENT that differs from the provisions of the offer of SELLER shall be binding on SELLER only if and to the extent that SELLER had expressly accepted it in writing.

3.4 In addition, for the purposes of paragraph 3.2 letter b) above, in case the acceptance of SELLER includes terms and condition different from those of the order of CLIENT, the Sale Contract shall be deemed to be concluded at the conditions included in the acceptance of SELLER, unless CLIENT notifies SELLER, in writing, not to accept the terms and conditions of the acceptance of SELLER within 1 (one) working day from the receipt of such acceptance.

3.5 All supplies of Products will only include what is expressly indicated in Sale Contract.

3.6 CLIENT recognizes to SELLER quantity and quality tolerances as resulting from the Sale Contract or from the usage and practices of the sector of the Products.

4) Packing – Delivery term – Delivery time

4.1 The Products will be packaged and readied to ship in compliance with the standard protection methods generally adopted by SELLER for the Products in

question, in consideration of the agreed mode of transport.

CLIENT shall expressly request to SELLER any special packaging or supplementary protection it deems necessary, and in such event CLIENT will bear all related costs thereof.

4.2 Unless otherwise provided for in the Sale Contract, the Products shall be delivered to CLIENT in accordance with the Incoterms® ICC rule, latest version, Ex-Works (EXW) – premises of SELLER indicated in the Sale Contract.

CLIENT authorizes SELLER to undersign, in the name and on behalf of CLIENT, any and all transport documents which shall be signed at the time of collection of the Products at the premises of SELLER, such as the CMR.

In the event that the ICC Incoterms® rule agreed between the parties provides that CLIENT shall take care of the transportation of the Products outside the territory of Italy:

a) in case of an Intra-EU supply, within 45 (forty-five) days from the receipt of the Products at its premises, CLIENT shall send SELLER an original or a copy of the international transportation document CMR or of another transportation document, undersigned at destination by CLIENT or, in the absence of the international transportation document CMR, a declaration of receipt of the Products issued on the basis of the form as Annex -1- available for download at www.panariagroup.it;

b) in case of an Extra-EU supply, CLIENT shall:

i) submit the custom export declaration (SAD-EX + EAD) and execute the validation of the MRN (Movement Reference Number) at the customs of the UE territory of exit of the Products, within 90 (ninety) days from the date of delivery of the same in Italy;
ii) send SELLER, within 90 (ninety) days from the date of delivery, documents proving the exportation of the Products (custom export declaration SAD-EX + EAD + certification of exit);

iii) notify SELLER, in writing, as soon as such submission is accomplished and provide SELLER with any other document proving the execution of such formalities as well as the exit of the Products from the UE Territory.

In case CLIENT is in breach of its obligations under this paragraph 4.2, SELLER shall be entitled to immediately charge CLIENT the amount of the Value Added Tax applicable to the supply and connected to the lack of proof of the transportation of the Products in a another Member State of the EU or to the lack of execution of custom clearance formalities. In any case, CLIENT shall indemnify and hold SELLER harmless with reference to any payment due to tax offices for fines, interests or on any other basis, in connection with the supply and with the lack of the proof of the transportation of the Products in a another Member State of the EU or with the lack of execution of custom clearance formalities.

In this respect, SELLER shall be entitled to: (i) offset any amount due by CLIENT on the basis of this paragraph 4.2 against any amount due, for whatever reason, from SELLER to CLIENT; or (ii) definitively withhold any amount received in regard to Sale Contracts, offsetting the CLIENT's debt under this paragraph 4.2 against any and all sums already paid by CLIENT.

4.3 SELLER shall deliver the Products within the delivery date provided for in the Sale Contract, in a single delivery or in partial deliveries. The delivery date shall always be considered neither of the essence nor peremptory.

Except in case of wilful wrongdoing or gross negligence, SELLER will not reimburse possible damages, either direct or indirect, suffered by CLIENT as a result of delay in the delivery of the Products.

In no case of delay in the delivery of the Products shall CLIENT be entitled to terminate the Sale Contract.

4.4 Upon receipt of the Products, CLIENT must report possible damages occurred to the packaging and/or shortages or anomalies of the Products occurred during the transport, by notifying details of such events on the transportation document, and must also:

a) have such notification countersigned by the carrier; and
b) immediately inform SELLER thereof, in writing, and send SELLER a copy of the countersigned document by and no later than 8 (eight) day(s) from the date of receipt of the Products.

Should this not be the case, SELLER shall not be responsible for possible damages losses or theft of the Products occurred during the transport, even if transport risks were, in whole or in part, upon SELLER.

5) Prices – Payment – Late Payment

5.1 The Products shall be supplied at the prices agreed between the parties in the Sale Contract or, should no prices be mentioned in the Sale Contract, at the prices resulting from the price list of SELLER in force when the Sale Contract has been executed. Unless otherwise stated in writing, the prices of the Products included in SELLER's price lists, quotations and/or offers are in Euro, net of VAT and for delivery according to the Incoterms® ICC rule, latest version, Ex-Works (EXW) - premises of SELLER indicated in the Sale Contract. Therefore, should a different Incoterms® rule be agreed upon between the parties for the delivery of the Products, the invoiced amount shall be modified accordingly, including in the sale invoice transportation expenses and any other costs connected with the Incoterms® rule agreed between for delivery.

5.2 CLIENT shall pay for the Products in accordance with the payments methods and terms provided for in the Sale Contract or otherwise agreed upon in writing between the parties. No payment shall be considered as being made by CLIENT until the relative amount has been credited to the bank account of SELLER. Payment shall be executed by CLIENT in Euro or in the currency of the place where CLIENT has its registered office, at SELLER's discretion, in accordance with the currency indicated by SELLER in the related sale invoice.

5.3 If CLIENT is delinquent in its payment obligation, SELLER may:

a) obtain payment of late payment interest in accordance with the applicable law; and
b) withhold ongoing and future deliveries, upon written notice to CLIENT, until all delinquent amounts and late payment interest are fully paid.

5.4 If delinquent amounts and late payment interest remain unpaid 30 (thirty) days after the agreed deadline for payment, then SELLER may also, at its option, alternatively or cumulatively, and in addition to any other right or remedy available at law or pursuant to these General Conditions:

a) request accelerated payment of any and all remaining payments and declare due

the total outstanding balance, even if payment by instalment or deferred payment has been agreed upon and/or bills of exchange, promissory notes, cheques or other payment documents have been issued and are falling due;

b) terminate the Sale Contract in question and definitively withhold any amount received in regard to such Sale Contract or to other Sale Contracts, offsetting the CLIENT's outstanding debt against any and all sums already paid by CLIENT;
c) carry out future deliveries of Products on a pre-payment basis only, also with reference to supplies still to be executed;
d) cancel discounts and bonuses that may have been agreed between the parties also with reference to Sale Contracts already regularly executed.

5.5 SELLER shall be entitled to exercise the rights mentioned in paragraphs 5.3 and 5.4 above also in case:

a) CLIENT is undergoing winding-up, bankruptcy, debt restructuring or enforcement proceedings;
b) the insurance company of SELLER refuses insurance coverage for SELLER's credits toward CLIENT;

c) CLIENT is undergoing financial difficulties able to hinder the regular execution of its payment obligations resulting from, by way of example only, missed payment of bills of exchange, promissory notes, cheques or other payment documents, reduction of granted guarantees and/or missed granting of promised guarantees, as well as from any amount resulting unpaid, even though such circumstances have occurred with other suppliers of CLIENT.

5.6 CLIENT cannot claim any breach of contract by SELLER, nor can CLIENT start any lawsuit or action against SELLER, until any amount resulting due to SELLER under paragraphs 5.3 and 5.4 above has been paid in full by CLIENT.

6) Retention of Title

6.1 SELLER will maintain exclusive ownership over the Products sold until their price has been entirely paid by CLIENT.

Without prejudice to the above the risks of loss of the Products shall be regulated by the Incoterms® rule agreed between the parties for the delivery of the Products.

6.2 In case of non-fulfilment or late fulfilment of the obligation to pay the price of the Products, without prejudice to the rights under paragraphs 5.4, 5.5 and 5.6, SELLER shall be entitled to enter the premises where the Products are held, repossess the Products and withhold, as liquidated damages, any amount already paid by CLIENT with reference to such Products.

7) Warranty

7.1 Without prejudice to the provisions of paragraphs 2.1, 2.2, 2.4 and 3.6 with reference to the modifications to the Products and tolerances, SELLER warrants that the Products will conform to the Sale Contract, to the classification indicated in the technical manuals, catalogues and/or price lists of SELLER and that they will be free from manufacturing defects.

The warranty period is 12 (twelve) months from the date of collection of the Products from the premises of SELLER, regardless of the agreed Incoterms® rule for delivery.

7.2 The following are expressly excluded from warranty:

a) chromatic alterations and tone differences of the Products;
b) the Products identified in the Sale Contract as Products of quality lower than first-quality Products or as close-out sale Products or as special batches;
c) the Products applied and/or set up not in compliance with the industry standards applicable to the same;
d) the Products used or applied on surfaces and/or in spaces or environments different from those indicated by SELLER;

e) the Products used not in compliance with the instructions and/or indications provided by SELLER included in the catalogues and price lists of SELLER or in other way communicated to CLIENT by SELLER, included the instructions under paragraph 2.2;

f) the Products used not in compliance to the standard diligence and/or to the technics required by the nature of the Products;

g) frost resistance of the Products, unless such characteristic of the Products has been declared by SELLER in the technical manual of the Products;
h) characteristics of the Products as resulting from the classification of the pottery (i) executed by control and/or certification authorities other than authorities of the European Union Member States, and/or (ii) executed on the basis of criteria other than those used by SELLER.

7.3 Without prejudice to the provisions of paragraph 4.4 above, CLIENT shall inspect the Products as soon as possible and shall notify SELLER in writing of possible non-conformities or defects, by fax or email, within and no later than the following terms; failing to do so will result in the lapse of the warranty and the unenforceability of the warranty rights:

a) differences in type or quantity with respect to type or quantity agreed as well as other patent non-conformities or defects of the Products: 8 (eight) days from the delivery of the Products at the premises of CLIENT and, in any case, before application of the Products;

b) hidden non-conformities or defects of the Products: 8 (eight) days from the discovery of the same and, for avoidance of doubt, within the warranty period.

7.4 SELLER will have the right to examine the Products, or samples of the Products, which CLIENT claims to be non-conforming or defective, in order to verify the instructions relating to the set up and/or application of the Products and/or the use of the Products in accordance with the provisions of these General Conditions. In this respect, CLIENT shall be entitled to return to SELLER the Products that CLIENT considers to be non-conforming or defective only upon SELLER's written authorization and only on the condition that CLIENT bears all costs and risks for the shipment of the Products. The authorization to return the Products or samples of the purportedly non-conforming or defective Products shall never be interpreted as an acknowledgment of the claimed non-conformities or defects on the part of SELLER.

7.5 In case the Products are ascertained by SELLER as actually non-conforming or defective, CLIENT will be entitled only to obtain, at the SELLER's option:

a) replacement of the non-conforming or defective Products; or
b) partial or full exemption from payment of their price, depending on the seriousness of the non-conformities or of the defects.

7.6 For the purpose of paragraph 7.5 letter (a), the Products to be delivered in

replacement of non-conforming or defective Products shall be delivered to CLIENT in accordance with the Incoterms® 2010 ICC rule DDP - premises of CLIENT. The Products that have been replaced shall be, at SELLER's discretion, destroyed or disposed of by CLIENT, at its own costs, or returned to SELLER, at costs of SELLER. In case the Products are to be destroyed or disposed of by CLIENT, CLIENT undertakes to send to SELLER the proof of destruction or of disposal of the Products, along with the documents proving the costs borne by CLIENT for the destruction or the disposal of the same.

7.7 The rights and remedies described in paragraphs 7.5 and 7.6 above are the sole warranty rights and remedies granted to CLIENT. To the maximum extent permitted by the applicable law, any other liability and obligation of SELLER, which may in any way arise from or in relation to the supply of non-conforming or defective Products - including, but not limited to, compensation for direct or indirect or consequential damages, loss of profits, etc. connected to such liability - is expressly excluded.

7.8 The present warranty is in substitution for, and excludes, any other warranty, express or implied, set forth by the law or otherwise.

8) Force Majeure

8.1 SELLER shall not be liable or responsible for failure or delay in performing or fulfilling any obligations undertaken in reference to the supply of Products when such failure or delay is due to the occurrence of an event of force majeure such as wars, fires, earthquakes, floods, tsunamis, strikes, labor or employment difficulties, shortage or procurement difficulties of raw materials, restriction on the use of power, suspension or difficulties in the transports, breakdown of the plants, acts of public authorities or any other event or cause whatsoever, similar or dissimilar, which cannot reasonably be forecast or provided against and which cannot be overcome by SELLER with reasonable diligence.

8.2 In such event, the time for fulfillment of the obligation shall be extended for the period of continuance of such force majeure event.

In the event any of such force majeure event continue for a period longer than 6 (six) months, CLIENT shall have the right to terminate the underlying Sale Contract, by giving written notice to SELLER by registered letter with return receipt or courier, and SELLER shall not incur any responsibility or liability whatsoever.

9) Severability

The invalidity or unenforceability of any provision, or portion thereof, of this General Conditions shall not affect the validity or enforceability of any other provision.

10) Confidentiality

10.1 CLIENT undertakes: (i) to treat with the utmost confidentiality all the information/data/designs/know-how/documentation transmitted by SELLER or that it may come to know in connection with the execution of any Sale Contract, even if they are not marked or identified as secret or confidential ("Confidential Information"); (ii) not to, wholly or partially, disclose to or inform third parties of the Confidential Information, without the SELLER's prior written consent; (iii) to limit the use of the Confidential Information and the access to the same for purposes relating to the execution of the sale Contracts; (iv) to adopt any and all measures required in order for its employees and collaborators do not disclose the Confidential Information to third parties or use it in an inappropriate way.

The Confidential Information shall not be copied or reproduced in any way, unless with the prior written consent of SELLER, and all the copies of the Confidential Information shall be immediately returned to SELLER upon simple written request of the same.

10.2 The provisions above shall not apply to information which (i) are public or publicly available not due to a disclosure of CLIENT or of CLIENT's employees or collaborators; or (ii) were already available to CLIENT before it had received them by SELLER; or (iii) are disclosed from third parties that have no obligation of confidentiality or restrictions of use on the same; (iv) can be disclosed according to a written authorization of SELLER.

11) Applicable Law – Dispute Resolution

11.1 These General Conditions and all the Sale Contracts that will occur on the basis on the same will be governed by the United Nations Convention on Contracts for the International Sale of Goods (Vienna Convention of 1980) and, with respect to matters not covered by such Convention, by Italian laws.

11.2 Any dispute arising out of or in connection with these General Conditions or in connection with a Sale Contract occurred on the basis on the same shall be settled in accordance with the following provisions:

a) In case CLIENT has its registered office within the European Union, in Switzerland, in Norway or in Iceland, the dispute shall be subjected to the jurisdiction of the Italian courts and shall be exclusively referred for its resolution to the Court of Modena (Italy).

b) In any other case, the dispute shall be exclusively referred to and finally resolved by arbitration, by a sole arbitrator, in accordance with the Rules of the Milan Chamber of Arbitration (the Rules).

The seat of arbitration shall be, and the award shall be delivered in, Milan (Italy). The language to be used in the arbitral proceedings shall be English.

11.3 Irrespective of the provisions above, it is hereby granted exclusively to SELLER the right to initiate legal proceedings under the jurisdiction of CLIENT before the competent court.

12) Language of these General Conditions

12.1 The text of these General Conditions is executed in both in Italian and in English language. In case of any discrepancy, the text in Italian shall prevail over the text in English language.

These general terms and conditions of sale are published and downloadable on the website www.panariagroup.it



Ceramics of Italy

Seguici su / Follow us on



Group Marketing & Communications - Panariagroup
Gennaio 2020

Panaria
ceramica

via Panaria Bassa, 22/a
41034 Finale Emilia (Modena) - Italy
Tel. +39 0535 95111 - Fax +39 0535 90503
info@panaria.it - www.panaria.it

PANARIAGROUP INDUSTRIE CERAMICHE S.p.A.
www.panariagroup.it