

ROMAS

mediterranean taste





The taste of Aromas evokes elegant atmospheres, contributing to the cozy atmosphere of a comfortable living space, always mindful of design. The charm of terracotta floors, typically Mediterranean and welcoming, is brought to pleasant and minimalist surfaces to adapt to a new living style. Large surfaces, with astonishing shapes that create an original atmosphere thanks to their welcoming colors, simply natural, in a crescendo of intensity from the delicate Vanilla to the powerful Chili. Aromas evokes familiar memories and flavors without dwelling on tradition: the carefree domestic warmth is clearly hinted at in a material with an airy and informal appearance. It's the combination of warmth and linearity that makes Aromas the collection that matches to the new purpose of home: the space that welcomes affections and comfort, habits, but is also capable of transforming into a space dedicated to work and professionalism. Terracotta shades reinterpreted in a contemporary way are the ideal solution for floors and coverings; they lend themselves to an interior design that extends to the exterior, offering, for the first time, a slab format, complying with all the technical characteristics required for non-slip surfaces. Enriching the range is an innovative proposal of non-standard formats (approximately 1 square meter area), the unconventional: Large Pentagon, Giga Hexagon, Gem Hexagon, Tangram, and Origami, resulting in unprecedented installations with an unusual effect. A shiny and fun pattern adds a surprising touch of flavor to offer more decorative surfaces, in chromatic continuity, suitable for floors and coverings. The precious decoration of a fascinating pattern.

Colori caldi per forme contemporanee e superfici gradevoli. Il sapore di Aromas rimanda ad atmosfere eleganti, per contribuire al comfort di un abitare confortevole e sempre attento al design. Il gusto dei pavimenti in cotto, tipicamente mediterraneo e accogliente, riportato su superfici piacevoli e minimaliste, per adeguarsi ad un nuovo stile abitativo. Superfici grandi, dalle sagome sorprendenti che creano un'atmosfera originale grazie ai loro colori accoglienti, semplicemente naturali, in un crescendo di intensità dal tenue Vanilla fino al potente Chili. Aromas rimanda a ricordi e sapori familiari, senza indugiare sulla tradizione: la spensieratezza del calore domestico viene semplicemente accennata in un materiale dall'aspetto arioso e informale. È il connubio fra calore e linearità a fare di Aromas la collezione che corrisponde alla nuova funzione di casa: lo spazio che accoglie gli affetti e la comodità, le abitudini, ma anche capace di trasformarsi nello spazio dedicato al lavoro e alla professionalità. Le sfumature della terracotta reinterpretate in chiave contemporanea sono la soluzione ideale per pavimenti e rivestimenti; si prestano al progetto interno che continua in esterno, offrendo per la prima volta un formato lastra, conforme a tutte le caratteristiche tecniche richieste per superfici antiscivolo. Arricchisce la gamma una proposta innovativa di formati non standard (area di circa 1 mq), gli unconventional: Large Pentagon, Giga Hexagon, Gem Hexagon, Tangram e Origami. Per pose inedite dall'effetto insolito. Una trama lucida e divertente aggiunge un sorprendente tocco di sapore per proporre superfici più decorative, in continuità cromatica, adatte per pavimenti e rivestimenti. La decorazione preziosa di una trama affascinante.

Colours | Colori



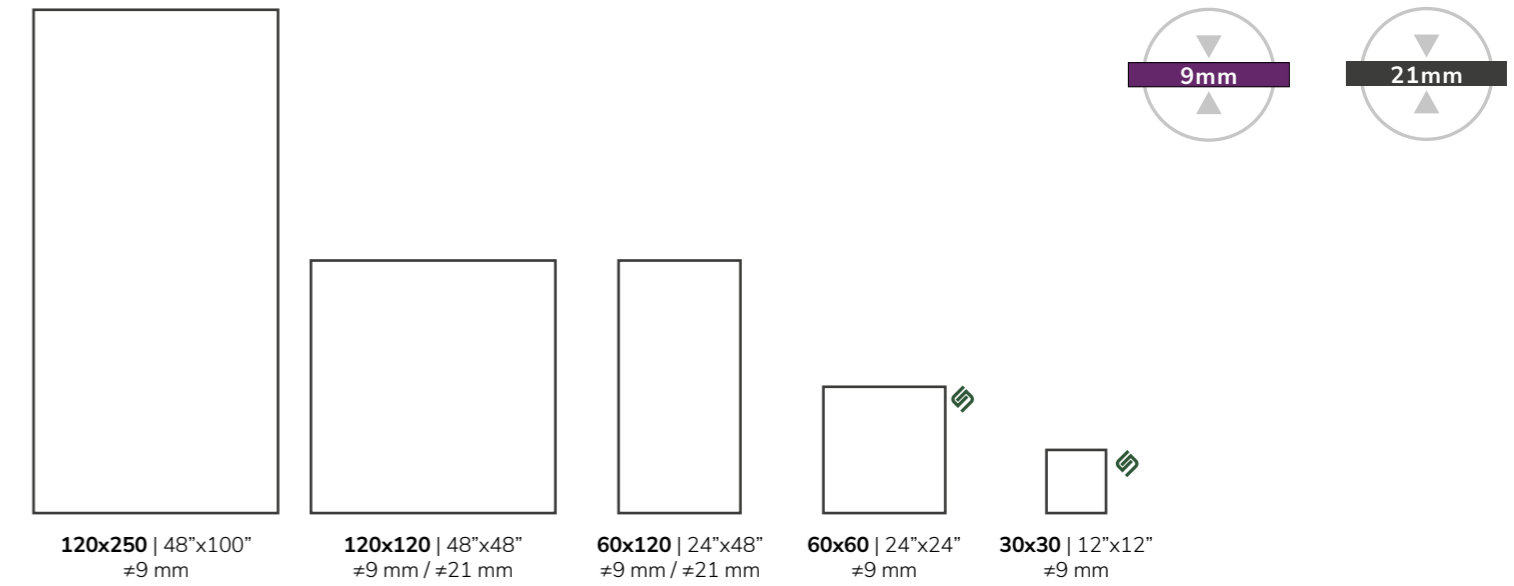

Sizes and thicknesses | Formati e spessori

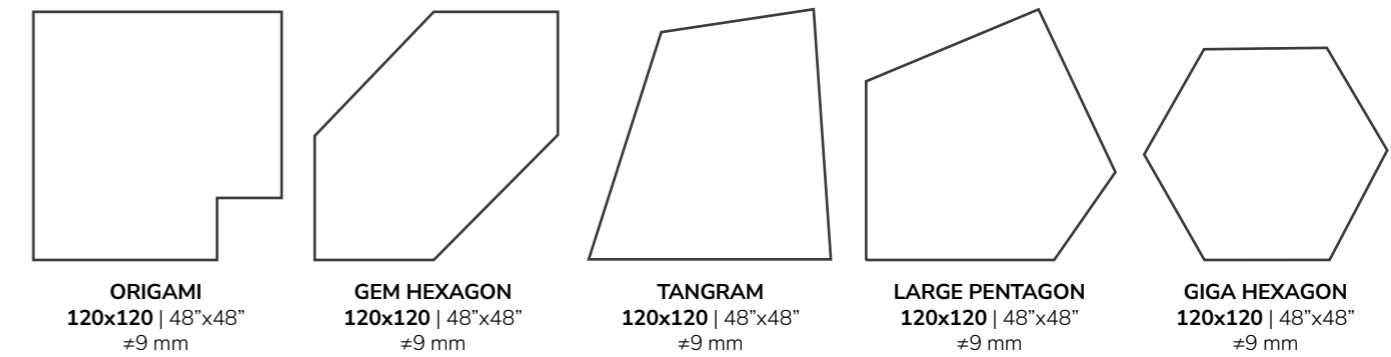
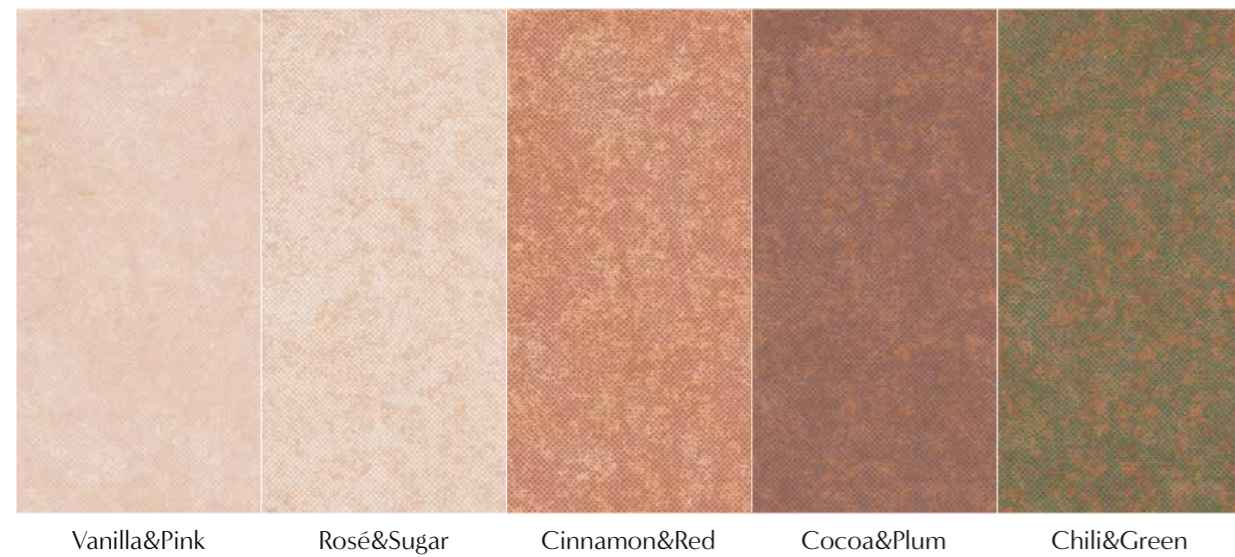

Texture | Texture



Texture are available in 48"x100" / 48"x48" / 24"x48". | **Le texture sono disponibili in 120x250 / 120x120 / 60x120 cm.**

All sizes are available in mat, soft and bocciardato R11 surfaces. | **Tutti i formati sono disponibili nelle superfici mat, soft e bocciardato R11.**
The only colour available in bocciardato R11 surface is Masala*. | **L'unico colore disponibile nella superficie bocciardato R11 è Masala*.**
The products with  will be manufactured only upon specific request. | **Gli articoli con  saranno prodotti solo su specifica richiesta.**

ROMAS

Mediterranean taste



FLOOR | PAVIMENTO

Aromas Cinnamon Soft 120x120 / 48"x48" / #9 mm

Aromas Masala Bocciardato R11 120x120 / 48"x48" / #21 mm

FLOOR | PAVIMENTO
Aromas Chili&Green 120x250 / 48"x100" / #9 mm



FLOOR | PAVIMENTO
Aromas Vanilla Soft Tangram / #9 mm



FLOOR | PAVIMENTO
Aromas Vanilla Soft Tangram / #9 mm

WALL | RIVESTIMENTO
Aromas Vanilla Soft 120x250 / 48"x100" / #9 mm

ROMAS

Unconventional shapes / Gem Hexagon



FLOOR | PAVIMENTO
Aromas Rosé Soft Gem Hexagon / #9 mm

WALL | RIVESTIMENTO
Aromas Rosé Soft 120x250 / 48"x100" / #9 mm
Aromas Rosé&Sugar 120x250 / 48"x100" / #9 mm
Aromas Rosé&Sugar 120x120 / 48"x48" / #9 mm



WALL | RIVESTIMENTO
Aromas Rosé&Sugar 120x250 / 48"x100" / #9 mm

FLOOR | PAVIMENTO
Aromas Rosé Soft Gem Hexagon / #9 mm

FLOOR | PAVIMENTO

Aromas Cinnamon Mat Large Pentagon / #9 mm

TABLE | TAVOLO

Aromas Cinnamon Soft Gigacer Service / #9 mm

Aromas Cinnamon&Red Gigacer Service / #9 mm



FLOOR | PAVIMENTO

Aromas Cinnamon Mat Large Pentagon / #9 mm

SKIRTING | BATTISCOPIA

Aromas Cinnamon Mat 7,5x120 cm / 3"x48" / #9 mm

TABLE | TAVOLO

Aromas Cinnamon Soft Gigacer Service / #9 mm

Aromas Cinnamon&Red Gigacer Service / #9 mm

ROMAS

Unconventional shapes / Giga Hexagon



FLOOR | PAVIMENTO
Aromas Cocoa Soft Giga Hexagon / #9 mm

WALL | RIVESTIMENTO
Aromas Cocoa&Plum 30x30 / 12"x12" / Gigacer Service / #9 mm

FLOOR | PAVIMENTO
Aromas Cocoa&Plum Giga Hexagon / Gigacer Service / #9 mm

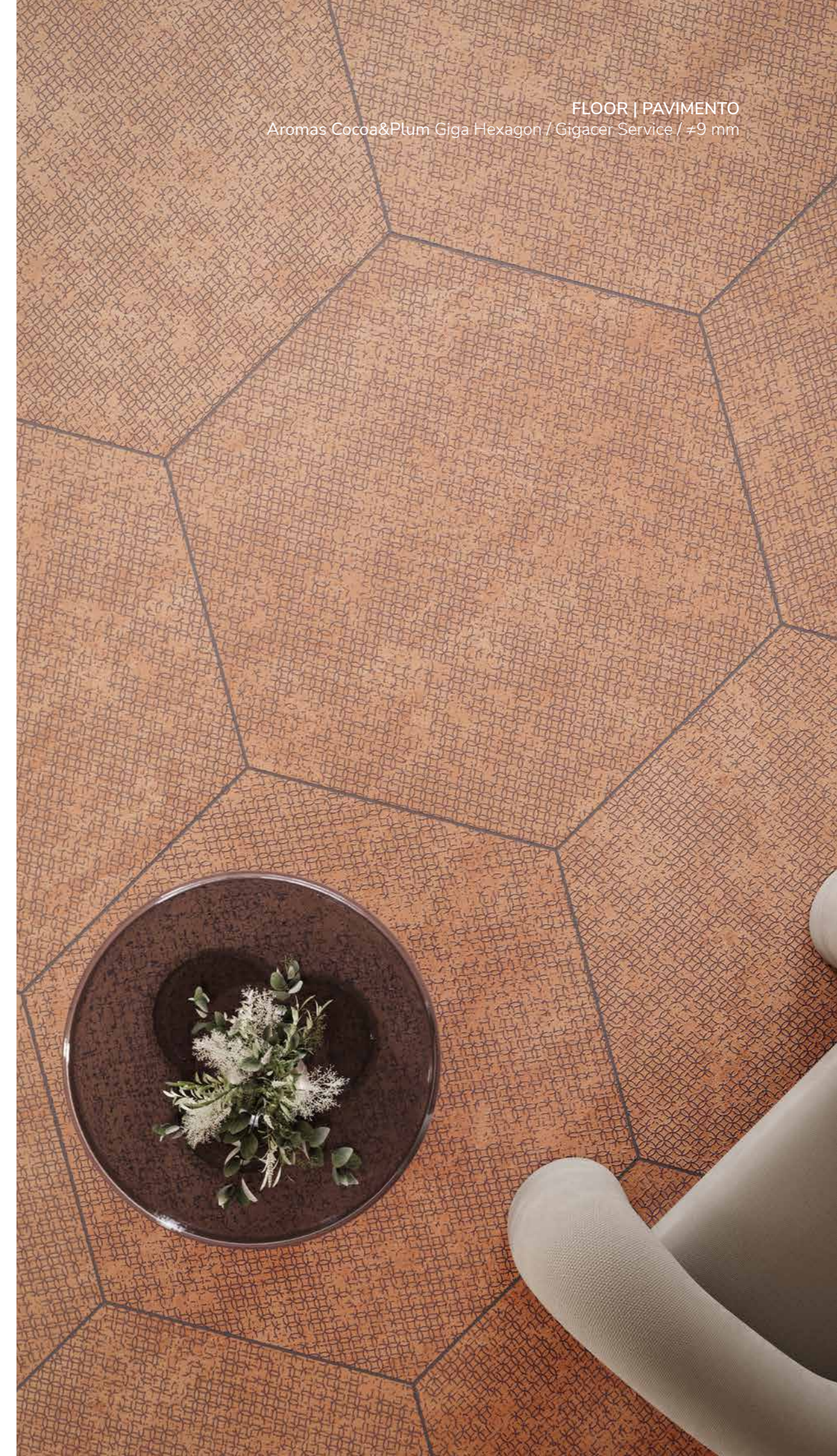

FLOOR | PAVIMENTO
Aromas Chili Mat Origami / #9 mm

COFFEE TABLE COUNTER TOP | PIANO DEI TAVOLINI
Aromas Chili&Green Gigacer Service / #9 mm



WALL | RIVESTIMENTO
Aromas Chili Soft 120x250 / 48"x100" / #9 mm
Aromas Chili&Green 120x250 / 48"x100" / #9 mm

BAR DESK | BANCONE BAR
Concrete White Gigacer Service / #6 mm
Bamboo Abisso Velato Craquelé 15x15 / 6"x6" / #10 mm
Bamboo Abisso Velato Quartino 1x15 / 0,4"x6" / #10 mm

FLOOR | PAVIMENTO
Aromas Chili Mat Origami / #9 mm

COFFEE TABLE COUNTER TOP | PIANO DEI TAVOLINI
Aromas Chili&Green Gigacer Service / #9 mm

ROMAS

Mediterranean taste

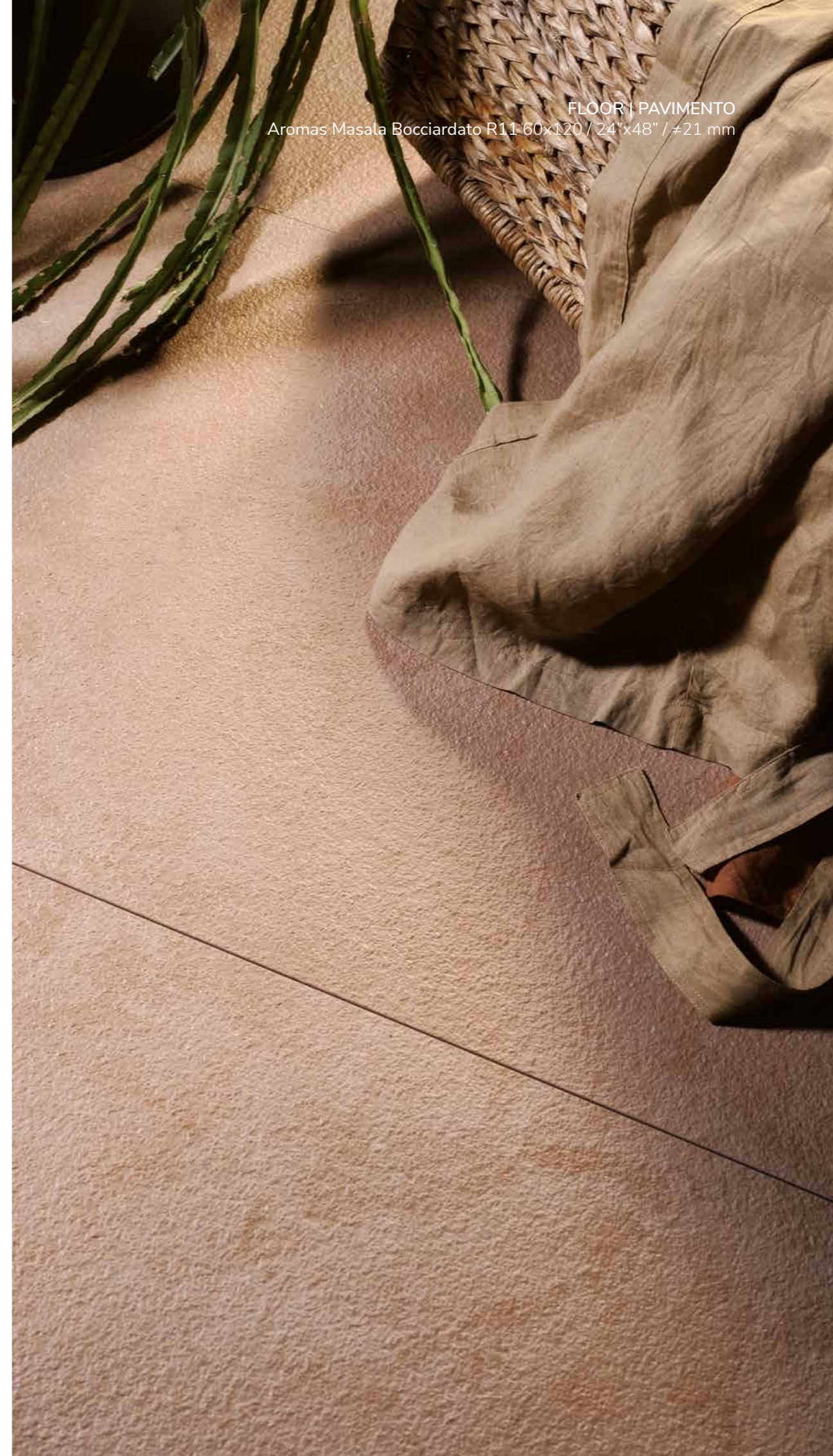
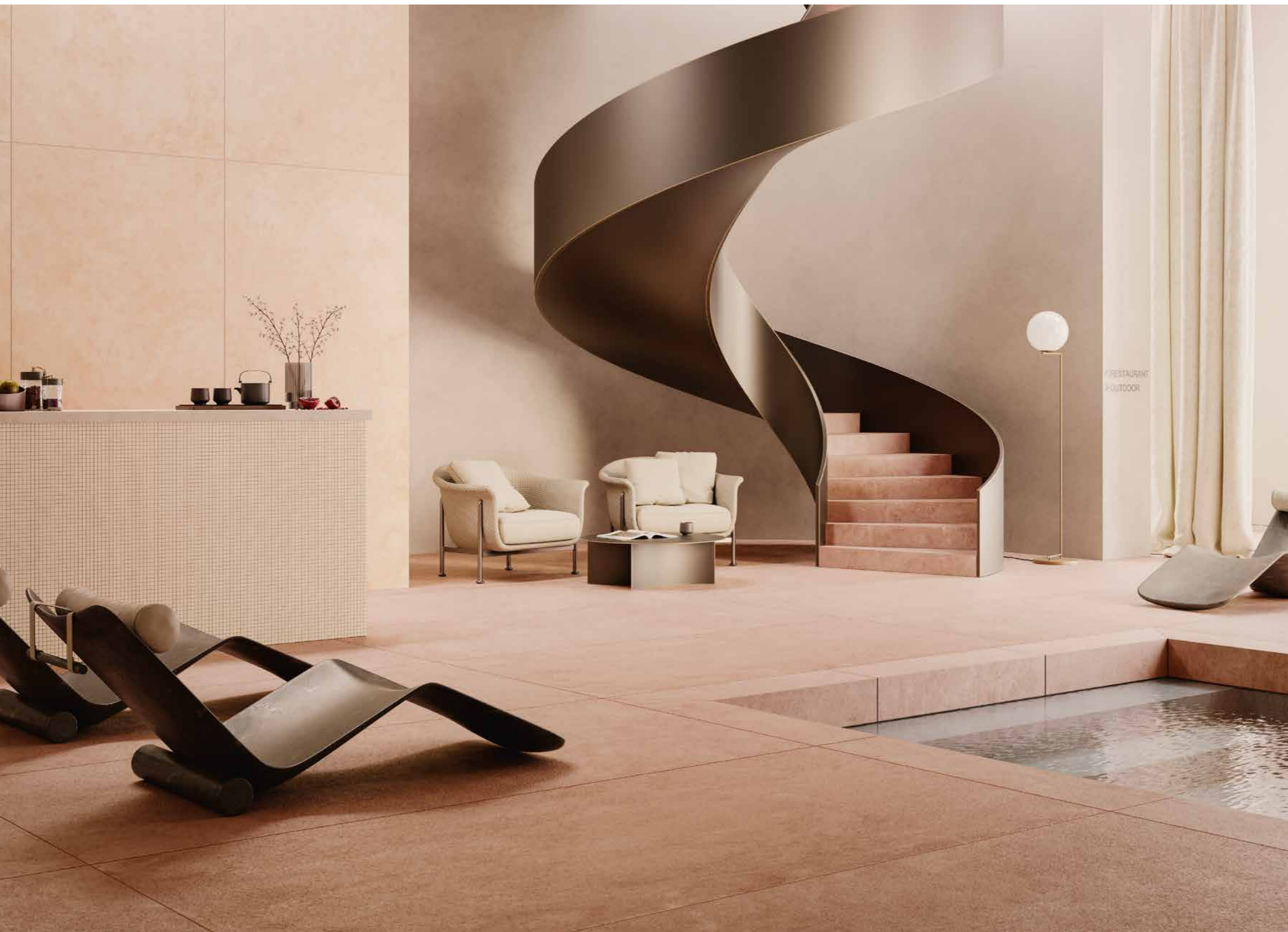

FLOOR | PAVIMENTO
Aromas Masala Bocciardato R11 60x120 / 24"x48" / #21 mm

FLOOR | PAVIMENTO
Aromas Masala Bocciardato R11 120x250 / 48"x100" / #9 mm

WALL | PARETE
Aromas Rosé Soft 120x250 / 48"x100" / #9 mm

VELA STEPS | GRADONI VELA
Aromas Masala Bocciardato R11 120x30x18 cm / 48"x12"x7" / #9 mm

CONSOLLE | BANCONE
Elementa Ivory Stone Mat Mosaic 30x30 / 12"x12" / #6 mm

FLOOR | PAVIMENTO

Aromas Vanilla Mat 60x120 / 24"x48" / #9 mm



FLOOR | PAVIMENTO

Aromas Vanilla Mat 120x120 / 48"x48" / #9 mm

WALL | RIVESTIMENTO

Aromas Vanilla Soft 120x250 / 48"x100" / #9 mm
Bamboo Verde Oliva Craquelé 15x15 / 6"x6" / #10 mm

Laying suggestions | Schemi di posa

Tangram

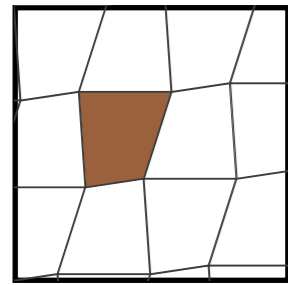
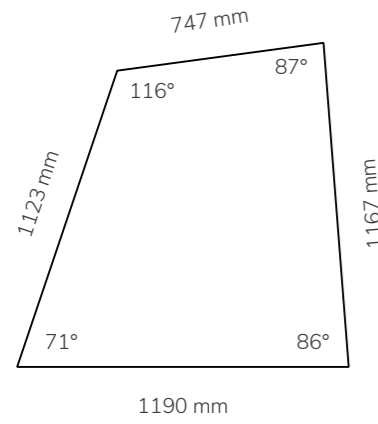

Tangram	100%
---------	------

Gem Hexagon

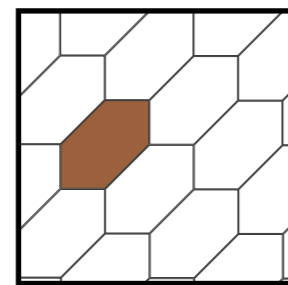
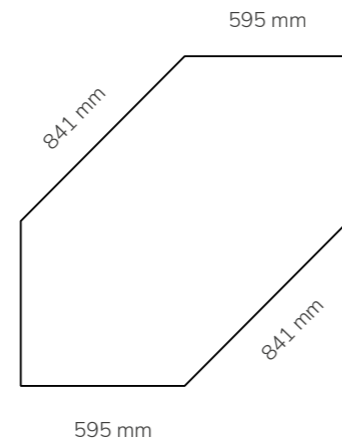

Gem Hexagon	100%
-------------	------

Large Pentagon

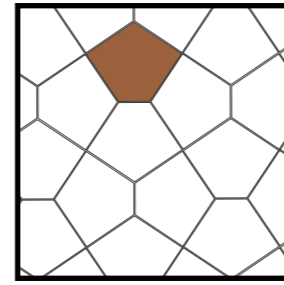
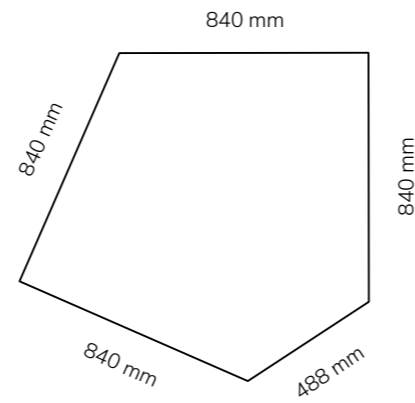

Large Pentagon	100%
----------------	------

Giga Hexagon

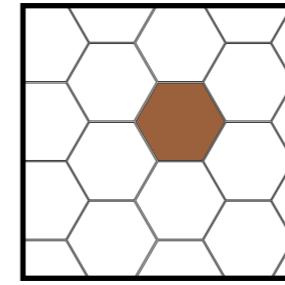
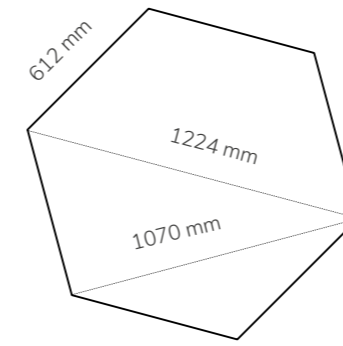

Giga Hexagon	100%
--------------	------

Origami

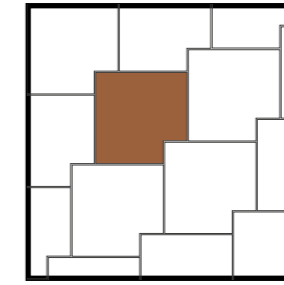
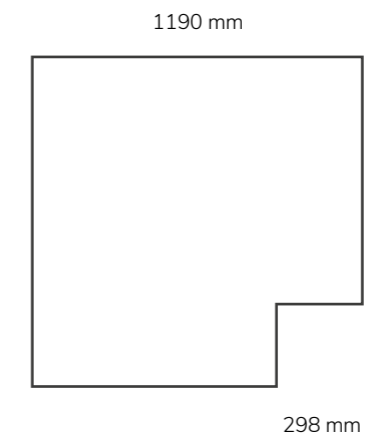

Origami	100%
---------	------

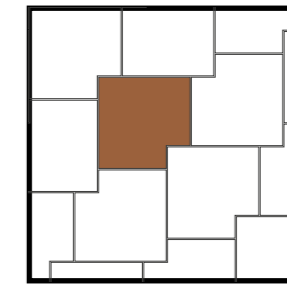

Origami	100%
---------	------

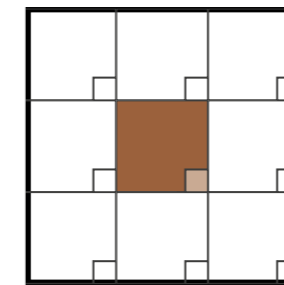

Origami	75%
30x30 cm 12"x12"	25%

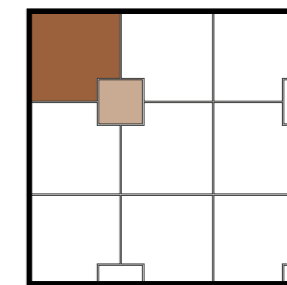

Origami	75%
60x60 cm 24"x24"	25%

The laying patterns are approximate. | **Gli schemi di posa sono stati calcolati con un'approssimazione.**
Joint spacing recommended: 2mm | **Fuga consigliata: 2mm.**

Shade variation index | Indice di stonizzazione

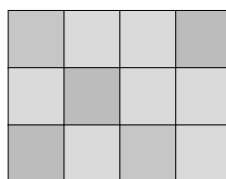

V2 - MODERATE

Product with light chromatic variation. / Prodotto con leggera variazione cromatica.

Calibers Calibri

Our slabs are always rectified and the table below indicates their final size in millimetres. Our standard caliber is 09 and all sizes with the same caliber, when multiples, are modular with 2 mm joint spacing. / Le nostre lastre sono sempre rettificate e hanno dimensioni finali in millimetri come da tabella. Il calibro standard è lo 09 e i formati dello stesso calibro multipli tra loro sono modulari con 2 mm di fuga.

NOMINAL SIZE (CM) FORMATO NOMINALE (CM)	RECTIFIED SIZE (MM) FORMATO RETTIFICATO (MM)	CALIBER CALIBRO
30x30	296x296	09
60x60	594x594	09
60x120	594x1190	09
120x120	1190x1190	09
120x250	1190x2500	09

Coefficient of friction | Coefficiente d'attrito

PORCELAIN SLABS / LASTRE DI GRES PORCELLANATO - ISO 13006 - G - BIA UGL (E ≤ 0,5%) UNI EN 14411 - G -									
		THICKNESS SPESSORE	DIN EN 16165 Annex B	DIN EN 16165 Annex A	BCR	BRITISH PENDULUM BS7976	UNE 41901:2017 EX	R9729 UPI/EMPA	DCOF (ANSI A 137.1:2019)
 COEFFICIENT OF FRICTION COEFFICIENTE D'ATTRITO	SOFT	≠9 mm	-	-	-	-	-	GS1	-
	MAT	≠9 mm ≠21 mm	R10	A+B	> 0,40	> 36 WET	Clase 2	GS2 / GB1	> 0,42 WET
	BOCCIARDATO	≠9 mm ≠21 mm	R11	A+B+C	> 0,40	> 36 WET	Clase 3	GS2 / GB1	> 0,42 WET

The values of slip resistance and of static and dynamic friction coefficient shown in the catalogue, and in the web site are merely indicative and non-binding. Any possible specific requirement must be confirmed by us at the order and anyway always before the installation. / I valori di resistenza allo scivolamento, coefficiente di attrito statico e dinamico, riportati sul catalogo e sul sito, sono da ritenersi puramente indicativi e non vincolanti. Ogni eventuale specifica necessità dovrà essere da noi confermata al momento dell'ordine e comunque sempre prima della posa.

Does not damage with chemical detergents anticovid. / Non si danneggia con i detersivi chimici anticovid.

Technical specification | Caratteristiche tecniche

PORCELAIN SLABS / LASTRE DI GRES PORCELLANATO ISO 13006 - G - BIA UGL (E ≤ 0,5%) UNI EN 14411 - G -					
	TECHNICAL SPECIFICATIONS CARATTERISTICHE TECNICHE	STANDARD NORMA ISO	THICKNESS SPESSORE	INTERNATIONAL STANDARDS VALORI PRESCRITTI DALLE NORME	AVERAGE GIGACER VALUE VALORE MEDIO GIGACER
	DIMENSIONAL CHARACTERISTICS CARATTERISTICHE DIMENSIONALI				
	SIDES LATI	ISO 10545-2	-	± 0,6%	± 0,2%
	THICKNESS SPESSORE		-	± 5%	± 3%
	STRAIGHTNESS OF EDGES RETTILINEITÀ DEGLI SPIGOLI		-	± 0,5%	± 0,2%
	RECTANGULARITY ORTOGONALITÀ		-	± 0,6%	± 0,2%
	SURFACE FLATNESS PLANARITÀ		-	± 0,5%	± 0,2%
	WATER ABSORPTION ASSORBIMENTO D'ACQUA	ISO 10545-3	-	≤ 0,5%	≤ 0,1%
	BENDING STRENGTH RESISTENZA ALLA FLESSIONE	ISO 10545-4	≠ 9 mm	≥ 35 N/mm ²	≥ 40 N/mm ²
			≠21 mm	≥ 35 N/mm ²	≥ 50 N/mm ²
	BREAKING STRENGTH SFORZO DI ROTTURA	ISO 10545-4	≠ 9 mm	S ≥ 700 N (sp. < 7,5mm)	> 2100 N
			≠21 mm	S ≥ 1300 N (sp. < 7,5mm)	≥ 13600 N
	RESISTANCE TO DEEP ABRASION RESISTENZA ALL'ABRASIONE PROFONDA	ISO 10545-6	-	≤ 175 mm ³	≤ 145 mm ³
	COEFFICIENT OF LINEAR THERMAL EXPANSION COEFFICIENTE DI DILATAZIONE TERMICA LINEARE	ISO 10545-8	-	≤ 9x10 ⁻⁶ 6°c 1	≤ 7x10 ⁻⁶ 6°c 1
	RESISTANCE TO THERMAL SHOCKS RESISTENZA AGLI SBALZI TERMICI	-	-	AVAILABLE METHOD METODO DISPONIBILE	RESISTANT RESISTE
	FROST RESISTANCE RESISTENZA AL GELO	ISO 10545-12	-	AVAILABLE METHOD METODO DISPONIBILE	RESISTANT RESISTE
	RESISTANCE TO CHEMICAL ATTACKS RESISTENZA ALL'ATTACCO CHIMICO	ISO 10545-13	-	min. UB	RESISTANT RESISTE
	STAIN RESISTANCE RESISTENZA ALLE MACCHIE	ISO 10545-14	-	AVAILABLE METHOD METODO DISPONIBILE	RESISTANT RESISTE

We produce technical unglazed porcelain stoneware slabs, and some light impurities and dots must be considered as a standard feature of the product. / Trattandosi di un prodotto tecnico a solo impasto senza smalto alcune impurità e puntature visibili nei colori chiari sono da considerarsi una caratteristica tecnica del prodotto.

Packaging | Imballi

SIZE (CM) FORMATO	PALLET (CM)	PCS/BX PEZZI X COLLO	SQM/BX M ² X COLLO	KG/BX KG X COLLO	BX/PLT COLLI X PALLETT	SQM/PLT M ² X PALLETT	KG/PLT KG X PALLETT
9 mm							
30x30	80x120 euro	12	1,08	22,68	40	43,20	937
60x60	120x120	4	1,44	30,24	40	57,60	1234
60x120	120x120	3	2,16	45,36	22	47,52	1022
120x120	120x120	2	2,88	60,48	16	46,08	992
120x250	Standard crate 272x133x42h	1	3,00	42,60	22	66,00	1037
Giga Hexagon	124x137	1	0,99	20,79	32	31,68	695
Gem Hexagon	124x137	1	1,06	22,30	32	33,98	744
Large Pentagon	124x137	1	0,99	20,79	32	31,68	695
Origami	124x137	1	1,33	27,87	32	42,46	922
Tangram	124x137	1	1,07	22,43	32	34,18	748
Skirting Battiscopa 120x7,5	-	10	-	20,50	-	-	-
Costa retta step Gradino costa retta 120x33x4	-	2	-	39,00	-	-	-
Vela step Gradino a vela 120x30x18	-	1	-	16,00	-	-	-
21 mm							
120x120	120x120	1	1,44	70,60	16	23,04	1154
60x120	120x120	1	0,72	35,30	32	23,04	1154

Real colours and decorations might slightly differ from those depicted in this catalogue. / Quanto contenuto nel catalogo è puramente indicativo riguardo a colori e decorazioni.





GIGACER S.P.A.
via Caltagirone, n.72 / 48018 Faenza (RA) ITALY
Tel. +39 0546 637 111 / Fax +39 0546 637 127
info@gigacer.it
gigacer.it