

ADHESIVE TOOLS, TROWEL & SCRAPERS



THIN-SET ADHESIVE SPREADER

"COLOMBO" ADHESIVE SPREADER DEVICE○2

NOTCHED TROWELS

SLANT RIDGE NOTCHED TROWELS 28x13 cm AND 36x13 cm
(11"x5 1/8" AND 14 3/16"x5 1/8").....○3

RUBBER HANDLE NOTCHED TROWELS cm 36x13
(14 3/16"x5 1/8")○4

RUBBER HANDLE NOTCHED TROWELS 28x12 cm (11"x4 3/4") ○5

WOOD HANDLE NOTCHED TROWELS 28x12 cm (11"x4 3/4") ○6

NOTCHED TROWELS 48x13 cm (18 7/8"x5 1/8")○7

TRAPEZIAL NOTCHED TROWELS○8



OTHER TOOLS FOR ADHESIVE

THINSET SHOES FOR WALKING ON THINSET/ADHESIVE○9

PLATFORMS TO WALK OVER THE FLOOR WITHOUT MOVING

THE TILES○9

"FIDO" ERGONOMIC SUPPORT○9



SCRAPERS AND FINISHING TROWELS

TROWELS AND SCRAPERS○10

SMOOTH STEEL TROWELS○11

MIXING PADDLES AND BUCKETS

MIXING PADDLES AND BUCKETS○12



Everything you need for installation with adhesive. 48 models of notched trowels available with 18 Notch Notch types of teeth, with rubber or wooden handle. In addition to that, "Colombo", the device to spread the adhesive, a special trowel designed for skirting as well as the platforms and shoes to walk on the floor with fresh adhesive. Furthermore we offer a wide range of smooth trowels, bricklayer trowels and spatulas as well as mixing paddles for drills. As regards to the mixing of adhesives, we refer to the previous section "mixers".

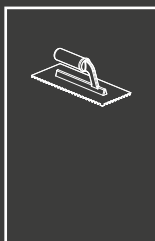

THIN-SET ADHESIVE SPREADER "COLOMBO"

MADE IN ITALY



397/66



397L36Q8/10



397L36Q6/12

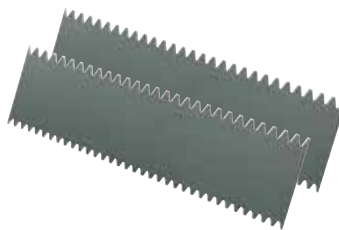

397L36V8/11



397L36T9/15

TECHNICAL FEATURES

INOX
IRON AND SULPHUR FREE

PACKAGE



"COLOMBO"

- For tiles up to 66 cm (26").
- Efficient and Easy-to-use.
- Saves the time for spreading the adhesive.
- The adhesive is spread in an upright position with a consistent and even depth.
- Since the "Colombo" is fully adjustable to the width of your tile, there is no possibility of extra

adhesive "skinning over" and creating a potential bond break. Spread only what you need.

- Supplied with: two dual notch blades with 8x8 - 10x10 mm and 6x6 - 12x12 mm 8x8 - 10x10 mm e 6x6 - 12x12 mm (5/16" x 5/16" - 13/32" x 13/32" e 1/4" x 1/4" - 15/32" x 15/32").

Part No.	Barcode	Icon	Description	Weight	Volume	Dimensions	Weight
397/66	8024648015440	1	"Colombo" for tiles up to 66 cm	11,5 Kg	25.4 lbs	50x50xh 27 cm	20"x20"xh10 5/8"

DUAL NOTCH BLADES

- Interchangeable stainless steel blades with magnetic Quick Change.

Part No.	Barcode	Icon	Notch type	Description	Notch size	Weight	Volume	Dimensions	Weight
397L36Q8/10	8024648015495	1		Dual notch blades 8/10 mm	8x8 mm 10x10 mm	1,4 Kg 3 lbs	40x15xh 5cm	15"x6"xh 2"	3 Kg 6.6 lbs
397L36Q6/12	8024648015501	1		Dual notch blades 6/12 mm	6x6 mm 12x12 mm				
397L36V8/11	8024648015518	1		Dual notch blades V 8/11 mm	8 mm 11 mm				
397L36T9/15	8024648015525	1		Dual notch blades 9/15 mm	9 mm 15 mm				



ADHESIVE TOOLS, TROWEL & SCRAPERS

SLANT RIDGE NOTCHED TROWELS 28x13 AND 36x13 cm (11"x5 1/8" AND 14 3/16"x5 1/8")

MADE IN E.U.

PATENTED



183HFV10



183HFV8



183HFV6



184HFV10G



184HFV08G

TECHNICAL FEATURES



PACKAGE



SLANT RIDGE NOTCHED TROWELS

- The slanted and rounded notch provide the following advantages:
 - maximum coverage: when placing the tile on adhesive spread with a slanted ridge, the ridges overlap and collapse to provide superior adhesive coverage and consequently avoid any air pocket under the tile/slab;
 - no air pocket under the tile/slab means avoid water infiltration in case of outdoor floors or swim-ming pools. Also, in case of thin slabs (3-7 mm thickness), it avoids any breakages

- caused by concentrated loads;
 - the absence of air under the tile improves the transmission of heat in case of underfloor heating;
 - the rounded shape of the notch reduces the chance of the adhesive "binding" and ripping away the ridges while troweling. The adhesive does not bind in the rounded corners of this notch so the adhesive ridges stay intact.
- Rubber handle mounted on a die-cast aluminum core.
 - Stainless steel, 100% rust-proof.

SLANT RIDGE NOTCHED 28x13 cm (11"x5 1/8")

Rust proof stainless steel 0.7 mm. Rubber handle mounted on a die-cast aluminum core.

Part No.	Barcode	Box	Notch type	Notch size		Trowel		Weight		Dimensions		Capacity	
183HFV10	8024648016737	6		10 mm	13/32"			32x22xh 15 cm	12 1/2"x8 5/8"xh 6"	2,3 Kg	5.1 lbs		
183HFV8	8024648016744	6		8 mm	5/16"								
183HFV6	8024648016751	6		6 mm	1/4"								

SLANT RIDGE NOTCHED 36x13 cm (14 3/16"x5 1/8")

- The 36x13 cm (14 3/16" x 5 1/8") size increases of 30% the coverage for each pass (compared to 28x12 cm - 11x4 3/4"); this makes this trowel perfect for larg format tiles.

Part No.	Barcode	Box	Notch type	Notch size		Trowel		Weight		Dimensions		Capacity	
184HFV10G	8050532005006	6		10 mm	13/32"			38x30xh 12 cm	15"x12"x h 4 3/4"	3 Kg	6.6 lbs		
184HFV08G	8050532004993	6		8 mm	5/16"								

ADHESIVE SPREADING WITH STANDARD NOTCHED TROWEL

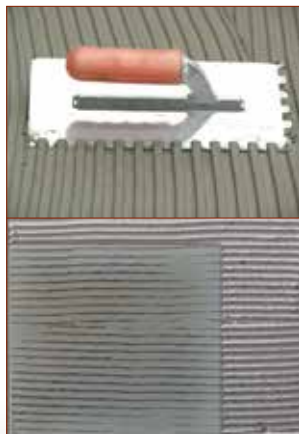

ADHESIVE SPREADING WITH SLANT RIDGE NOTCHED TROWEL

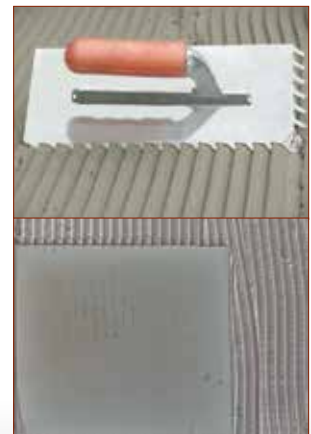

ADHESIVE TOOLS, TROWEL & SCRAPERS

RUBBER HANDLE NOTCHED TROWELS 36x13 cm (14 3/16"x5 1/8")

MADE IN ITALY



184Q12G

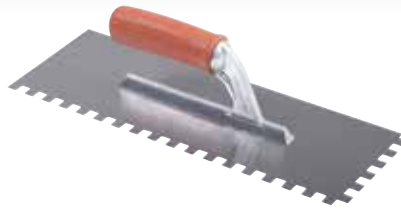

184Q10G



184Q03G



184V06G



184V09G



184Q08G



184Q06G



184T15G

PACKAGE



CARTON BOX

RUBBER HANDLE NOTCHED TROWELS 36X13 CM (14 3/16"X5 1/8")

- The 36x13 cm (14 3/16" x 5 1/8") size increases of 30% the coverage for each pass (compared to 28x12 cm - 11" x 4 3/4" trowel).
- Perfect for large format tiles.
- Stamped in tempered steel 7/10.

- Handles are made of polished aluminum electro-welded to the blade.
- Rubber handgrips.
- Handgrip provided with anti-rotation device.
- Available in square and round notch as well as V shape.

Part No.	Barcode	Box	Notch type	Notch size		36x13 cm	11"x5 1/8"	340 gr	12 oz	38x30xh12 cm	15"x12"xh 4 3/4"	3 Kg	6.6 lbs
184Q12G	8024648003911	6		12x12 mm	15/32" x 15/32"								
184Q10G	8024648003904	6		10x10 mm	13/32" x 13/32"								
184Q03G	8024648003874	6		3x3 mm	1/8" x 1/8"								
184Q06G	8050532001374	6		6x6 mm	1/4" x 1/4"								
184Q08G	8024648086785	6		8x8 mm	5/16" x 5/16"								
184V06G	8024648086716	6		8 mm	5/16"								
184V09G	8024648086723	6		11 mm	7/16"								
184T15G	8024648004208	6		15 mm	9/16"								

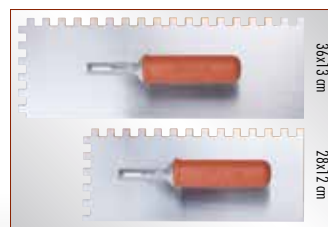

ADHESIVE TOOLS, TROWEL & SCRAPERS

RUBBER HANDLE NOTCHED TROWELS 28x12 cm (11"x4 3/4")

MADE IN ITALY



183 Q12G



183 Q10G



183 Q8G



183 Q6G



183 V9G



183 V6G



183 T15G



183 T9G

PACKAGE



CARTON BOX

RUBBER HANDLE NOTCHED TROWELS 28x12 cm (11"x4 3/4")

- Stamped in 22 gauge tempered steel 1/16" (1/42") with anti-corrosion treatment.
- Handles are made of polished aluminum electro-welded to the blade with rubber handgrips fastened by a non-slip screw.
- Rubber handgrips.
- Handgrip provided with anti-rotation device.

Part No.	Barcode	Box	Notch type	Notch size		Trowel		Weight		Box Dimensions		Weight	
183 Q12G	8024648010483	16		12x12 mm	15/32" x 15/32"	28x12 cm	11"x4 3/4"	340 gr	12 oz	63x30xh 12 cm	24 7/8"x11 7/8"xh 4 3/4"	5,8 Kg	12.8 lbs
183 Q10G	8024648010490	16		10x10 mm	13/32" x 13/32"								
183 Q8G	8024648010506	16		8x8 mm	5/16" x 5/16"								
183 Q6G	8024648010520	16		6x6 mm	1/4" x 1/4"	28x12 cm	11"x4 3/4"	340 gr	12 oz	63x30xh 12 cm	24 7/8"x11 7/8"xh 4 3/4"	5,8 Kg	12.8 lbs
183 Q3G	8024648078490	6		3x3 mm	1/8" x 1/8"								
183 V9G	8024648010551	16		11 mm	7/16"	28x12 cm	11"x4 3/4"	340 gr	12 oz	63x30xh 12 cm	24 7/8"x11 7/8"xh 4 3/4"	5,8 Kg	12.8 lbs
183 V6G	8024648007759	16		8 mm	5/16"								
183 T15G	8024648010537	6		15 mm	9/16"	28x12 cm	11"x4 3/4"	340 gr	12 oz	29x27xh 12 cm	11 3/8"x10 5/8"xh 4 3/4"	2,2 Kg	4.8 lbs
183 T9G	8024648010568	6		9 mm	3/8"								



WOOD HANDLE NOTCHED TROWELS 28x12 cm (11"x 4 3/4")

MADE IN ITALY

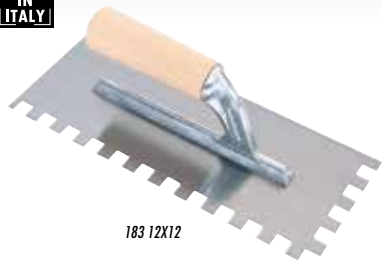

183 12X12

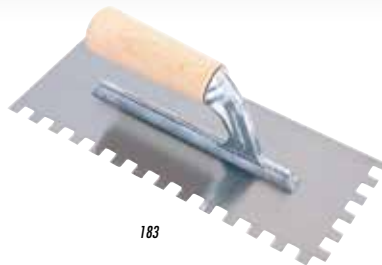

183

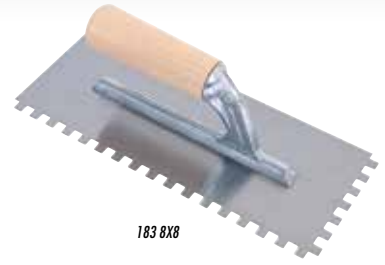

183 8X8

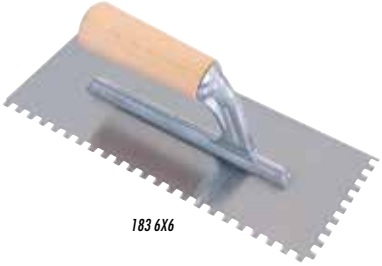

183 6X6



183 3X3

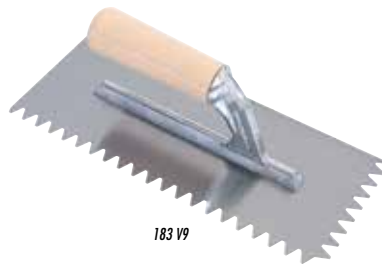

183 V9

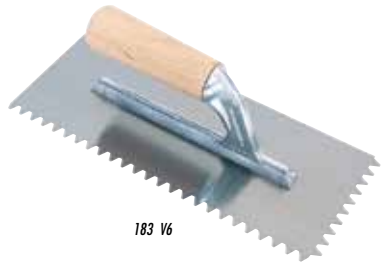

183 V6



183 V3

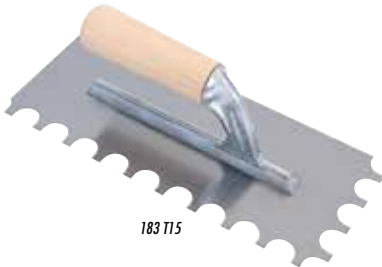

183 T15



183 T9

PACKAGE



CARTON BOX

NOTCHED TROWELS 28 x 12 cm (11"x4 3/4") WITH WOOD HANDLE

- Stamped in 22 gauge tempered steel 6/10 (1/42") with anti-corrosion treatment.
- Handles are made of polished aluminum electro-welded to the blade with waxed wood handgrips fastened by a non-slip screw.

Part No.	Barcode	Box	Notch type	Notch size	Blade	Weight	Volume	Weight
183 12X12	8024648000194	16		12x12 mm 15/32"x15/32"	28x12 cm 11"x4 3/4"	340 gr 12 oz	63x30xh 12 cm 24 7/8"x11 7/8"xh 4 3/4"	5,8 Kg 12.8 lbs
183	8024648000187	16		10x10 mm 13/32"x13/32"				
183 8X8	8024648000200	16		8x8 mm 5/16"x5/16"				
183 6X6	8024648000217	16		6x6 mm 1/4"x1/4"	28x12 cm 11"x4 3/4"	340 gr 12 oz	29x27xh 12 cm 11 3/8"x10 5/8"xh 4 3/4"	2,2 Kg 4.8 lbs
183 3X3	8024648010407	6		3x3 mm 1/8"x1/8"				
183 V9	8024648000231	16		11 mm 7/16"				
183 V6	8024648000224	16		8 mm 5/16"	28x12 cm 11"x4 3/4"	340 gr 12 oz	63x30xh 12 cm 24 7/8"x11 7/8"xh 4 3/4"	5,8 Kg 12.8 lbs
183 V3	8024648010544	6		3 mm 1/8"				
183 T15	8024648000248	6		15 mm 9/16"				
183 T9	8024648000255	6		9 mm 3/8"	28x12 cm 11"x4 3/4"	340 gr 12 oz	29x27xh 12 cm 11 3/8"x10 5/8"xh 4 3/4"	2,2 Kg 4.8 lbs

LEFT-HANDED WOOD HANDLE NOTCHED TROWELS 28x12 cm (11"x4 3/4")

Part No.	Barcode	Box	Notch type	Notch size	Blade	Weight	Volume	Weight
183 S	8024648010513	16		10x10 mm 13/32"x13/32"	28x12 cm 11"x4 3/4"	340 gr 12 oz	63x30xh 12 cm 24 7/8"x11 7/8"xh 4 3/4"	5,8 Kg 12.8 lbs
183 8X8S	8024648007742	16		8x8 mm 5/16"x5/16"				

ADHESIVE TOOLS, TROWEL & SCRAPERS

NOTCHED TROWELS 48x13 cm (18 7/8"x5 1/8")

MADE IN ITALY



182 12X12



182

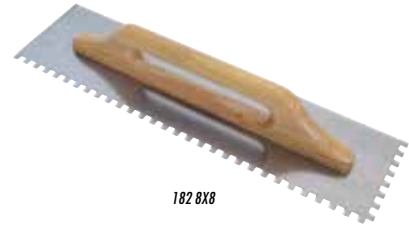

182 8X8

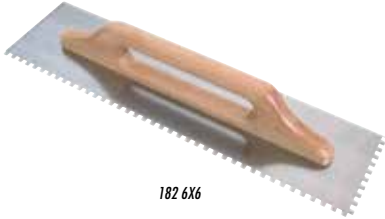

182 6X6

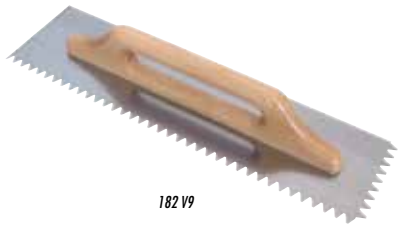

182 V9

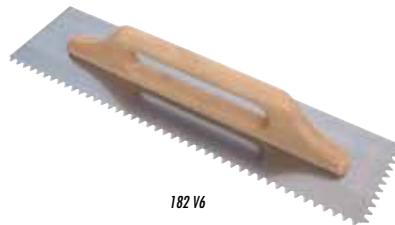

182 V6



182 T15

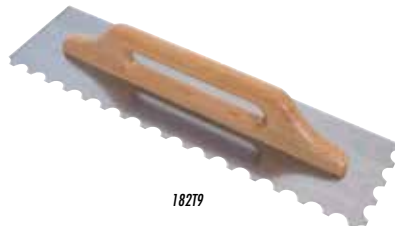

182 T9



NOTCHED TROWELS 48x13 cm (18 7/8"x5 1/8")

- Stamped in 21 guage tempered steel 7/10 (1/32") with anti-corrosion treatment.
- Handles are electro-welded to the blade.

- Handles are made of waxed wood handgrips.
- Bridge handle.

Part No.	Barcode	Box	Notch type	Notch size		Blade size		Weight		Dimensions			
182 12X12	8024648006660	12		12x12 mm	15/32" x 15/32"	48x13 cm	18 7/8" x 5 1/8"	600 gr	21.2 oz	49x34xh 17 cm	19 1/4" x 13 3/8" x h 6 5/8"	7,6 Kg	16.9 lbs
182	8024648000118	12		10x10 mm	13/32" x 13/32"								
182 8X8	8024648000125	12		8x8 mm	5/16" x 5/16"								
182 6X6	8024648000132	12		6x6 mm	1/4" x 1/4"								
182 V9	8024648000156	12		11 mm	7/16"								
182 V6	8024648000149	12		8 mm	5/16"								
182 T15	8024648000163	4		15 mm	9/16"								
182 T9	8024648006677	4		9 mm	3/8"	50x25xh 10 cm	20" x 10" x h 4"	2,7 Kg	6 lbs				



TRAPEZIAL NOTCHED TROWELS

MADE IN ITALY



148



149



148Q10

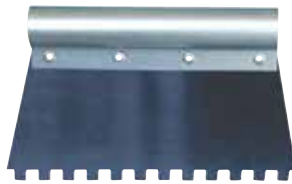

148Q8



148Q6

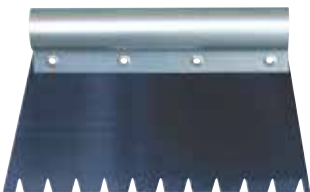

148N5



148N3



409 10X10

PACKAGE



CARTON BOX

NOTCHED TROWELS 28 cm (11") WITH PLASTIC HANDLE

Part No.	Barcode	Carton	Notch type	Notch size		Dimensions		Weight		Volume		Weight	
148	8024648000279	12		3 mm	1/8"	28 cm	11"	250 gr	8.8 oz	33x33xh 10 cm	13"x13"xh 4"	3,4 Kg	7.5 lbs
149	8024648000286	12		11 mm	7/16"								

NOTCHED TROWELS 20 cm (7 7/8") WITH STEEL HANDLE

Part No.	Barcode	Carton	Notch type	Notch size		Dimensions		Weight		Volume		Weight	
148 Q10	8024648014481	12		10x10 mm	13/32"x13/32"	20 cm	7 7/8"	100 gr	3.5 oz	22x15xh 13 cm	8 5/8"x5 7/8"xh 4"	1,3 Kg	2.9 lbs
148 Q8	8024648014498	12		8x8 mm	5/16"x5/16"								
148 Q6	8024648014504	12		6x6 mm	1/4"x1/4"								
148 N5	8024648007810	12		5 mm	3/16"								
148 N3	8024648007797	12		3,5 mm	9/64"								

"ZOCOLINA" NOTCHED TROWELS FOR SKIRTING

• Notched spatula for skirting/chairrail tiles. The unique design of this "trowel" allow the user to easily apply adhesive to these smaller, narrower tiles without waste or mess.

Part No.	Barcode	Carton	Notch type	Notch size		Dimensions		Weight		Volume		Weight	
409 10X10	8024648004932	12		10x10 mm	13/32"x13/32"	13 cm	5 1/8"	150 gr	5.3 oz	27x15xh 10 cm	10 5/8"x6"xh 4"	1,9 Kg	4.1 lbs

ADHESIVE TOOLS, TROWEL & SCRAPERS

MADE IN ITALY



137HUSKY

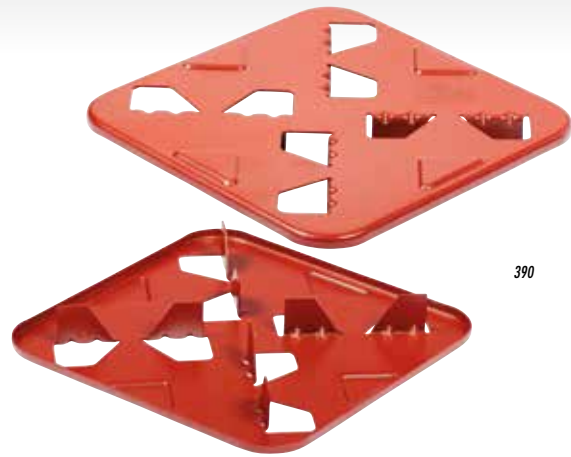

390



174



390BU



THINSET SHOES (FOR WALKING ON THINSET / ADHESIVE)

• Steel bottom, toe-guard made of replaceable nylon.

• Tip guard designed for safety shoes.

Part No.	Barcode	Box	Description	Weight	Dimensions	Volume	Weight	Volume
137HUSKY	8024648000057	4	Toothed shoes "Husky" (per pair)	1,7 Kg / 3.7 lbs	35x27xh 31 cm / 14"x10 5/8"xh 12"		7,2 Kg / 15.9 lbs	

"ISOLA" AND "PENISOLA" (PLATFORMS TO WALK OVER THE FLOOR WITHOUT MOVING THE TILES WHEN LAYING WITH ADHESIVE)

• The platforms have ridges which extend into the joint and enable the user to walk over the floor without disturbing the tiles.

• "Penisola": to walk on the floor during installation with adhesive - "T" layout.
• For joint larger then 2 mm (3/32").

• "Isola": to walk on the floor during installation with adhesive - "+" layout.



Part No.	Barcode	Box	Description	Weight	Dimensions	Volume	Weight	Volume
390	8024648000064	5	"Isola" To walk over the floor without moving the tiles (for "+" joints only)	1,45 Kg / 3.2 lbs	33x33xh 10 cm / 13"x13"xh 4"		7,7 Kg / 17 lbs	
390BU	8024648010667	5	"Penisola" To walk over the floor without moving the tiles (for "T" joints only)	0,75 Kg / 1.7 lbs	33x33xh 10 cm / 13"x13"xh 4"		4 Kg / 8.8 lbs	

"FIDO" ERGONOMIC SUPPORT

• Comfortable, stable and safe support during the operation of spreading adhesive, placing, adjusting, cleaning of tiles, etc.

• Particularly useful for laying large format tiles.

• Thanks to the ergonomic design the weight of the body is distributed in an optimum manner relieving fatigue and increasing the working area range of the operator thus reducing installation time.

• It comes with 4 white removable rubber feet (anti-slip and anti-stain): "FIDO" can be used (without feet) on adhesive already spread on the floor without disturbing the adhesive bed or (with feet) on installed tiles.
• Supplied in captivating packaging.

Part No.	Barcode	Box	Description	Weight	Dimensions	Volume	Weight	Volume
174	8024648086648	2	"FIDO" ergonomic support	0,5 Kg / 1.1 lbs	27x15xh10 cm / 10 1/2"x6"xh 4"		1,2 Kg / 2.6 lbs	



ADHESIVE TOOLS, TROWEL & SCRAPERS

TROWELS, BRICKLAYING TROWELS AND PROFESSIONAL SCRAPERS

MADE IN ITALY



341PQL



341PTN



342PQN



342PTN



342PAN



342PLG



342PFU



343SSL

PACKAGE



CARTON BOX

TROWELS

- Ergonomic design for a perfect and safe grip.
- Bi-material handle made in shock proof plastic and thermoplastic anti-slip rubber with finger guard. Additional anti-slip holes guarantee maximum grip.
- Sturdy and easy to clean thanks to the plastic injection system that makes the handle and the blade a single piece.
- Made in C55 first quality steel.
- Micro-fusion welding system guaranteed by every breakage and assures maximum strength, flexibility and reliability.
- Protected from rust by a special ecologic varnish.

Part No.	Barcode	Box	Description	Blade	Box	Weight
341PQL160	8024648065759	6	Square point. With anti-slip rubber handle and finger guard	160 mm 6 9/32"	40x15xh 16 cm	1,75 Kg 3.9 lbs
341PQL180	8024648066077	6	Square point. With anti-slip rubber handle and finger guard	180 mm 7"	40x15xh 16 cm	1,80 Kg 4 lbs
341PQL190	8024648066084	6	Square point. With anti-slip rubber handle and finger guard	190 mm 7 1/2"	40x15xh 16 cm	1,85 Kg 4.1 lbs
341PQL200	8024648066091	6	Square point. With anti-slip rubber handle and finger guard	200 mm 6 7/8"	42x16xh 17 cm	1,90 Kg 4.2 lbs

Part No.	Barcode	Box	Description	Blade	Box	Weight
341PTN160	8024648065766	6	Round point. With anti-slip rubber handle and finger guard	160 mm 6 9/32"	40x15xh 16 cm	1,70 Kg 3.7 lbs
341PTN180	8024648066152	6	Round point. With anti-slip rubber handle and finger guard	180 mm 7"	40x15xh 16 cm	1,75 Kg 3.9 lbs
341PTN190	8024648066169	6	Round point. With anti-slip rubber handle and finger guard	190 mm 7 1/2"	40x15xh 16 cm	1,80 Kg 4 lbs
341PTN200	8024648066176	6	Round point. With anti-slip rubber handle and finger guard	200 mm 6 7/8"	42x16xh 17 cm	1,85 Kg 4.1 lbs

BRICKLAYING TROWELS

- Ergonomic design for a perfect and safe grip.
- Bi-material handle made in shock proof plastic and thermoplastic anti-slip rubber with finger guard. Additional anti-slip holes guarantee maximum grip.
- Sturdy and easy to clean thanks to the plastic injection system that makes the handle and the blade a single piece.
- Made in C55 first quality steel.
- Micro-fusion welding system guaranteed by every breakage and assures maximum strength, flexibility and reliability.
- Protected from rust by a special ecologic varnish.

Part No.	Barcode	Box	Description	Blade	Box	Weight
342PQN140	8024648066268	6	Square point. With anti-slip rubber handle and finger guard	140 mm 5 1/2"	31x11xh 14 cm	1 Kg 2.2 lbs
342PTN140	8024648066275	6	Round point. With anti-slip rubber handle and finger guard	140 mm 5 1/2"	31x11xh 14 cm	0,8 Kg 1.8 lbs
342PAN140	8024648066237	6	Pointed trowel. With anti-slip rubber handle and finger guard	140 mm 5 1/2"	31x11xh 14 cm	0,7 Kg 1.6 lbs
342PLG140	8024648066251	6	Cat tongue shape. With anti-slip rubber handle and finger guard	140 mm 5 1/2"	31x11xh 14 cm	0,7 Kg 1.6 lbs
342PFU140	8024648066244	6	Olive leaf shape. With anti-slip rubber handle and finger guard	140 mm 5 1/2"	31x11xh 14 cm	0,65 Kg 1.4 lbs

PROFESSIONAL SCRAPERS

- Made in first quality steel.
- Handle made in beech selected wood.

Part No.	Barcode	Box	Description	Blade	Box	Weight
343SSL020	8024648066282	12	Handle made in beech selected wood	20 mm 6/8"	27x10xh 14 cm	0,7 Kg 1.5 lbs
343SSL030	8024648066299	12	Handle made in beech selected wood	30 mm 1 3/16"	27x10xh 14 cm	0,75 Kg 1.6 lbs
343SSL040	8024648066305	12	Handle made in beech selected wood	40 mm 1 5/8"	27x10xh 14 cm	0,80 Kg 1.7 lbs
343SSL050	8024648066312	12	Handle made in beech selected wood	50 mm 2"	27x10xh 14 cm	0,90 Kg 2 lbs
343SSL060	8024648066329	12	Handle made in beech selected wood	60 mm 2 3/8"	27x10xh 14 cm	0,95 Kg 2.1 lbs
343SSL070	8024648066336	12	Handle made in beech selected wood	70 mm 2 3/4"	27x10xh 14 cm	1 Kg 2.2 lbs
343SSL080	8024648066343	12	Handle made in beech selected wood	80 mm 3 1/8"	27x10xh 14 cm	1,05 Kg 2.3 lbs
343SSL090	8024648066350	12	Handle made in beech selected wood	90 mm 3 1/2"	27x10xh 14 cm	1,10 Kg 2.4 lbs
343SSL100	8024648066367	12	Handle made in beech selected wood	100 mm 4"	27x10xh 14 cm	1,20 Kg 2.6 lbs

ADHESIVE TOOLS, TROWEL & SCRAPERS

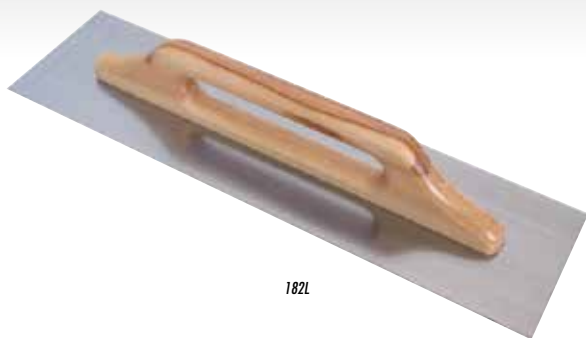

182L

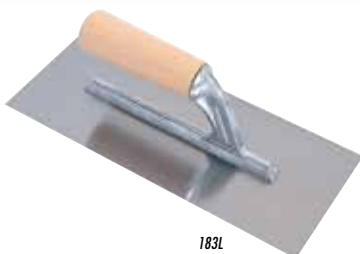

183L



183LG



184LG



142INX28



142INX24



142INX20



RECTANGULAR FINISHING TROWELS (STEEL)

- Stamped in 22 guage tempered steel 6/10 (1/42") with anti-corrosion treatment.
- Handles are made of polished aluminum electro-welded to the blade with waxed wood or rubber handgrips fastened by a non-slip screw.

Part No.	Barcode	Box	Tipo	Description	Blade Dimensions		Weight	Volume	Dimensions	Weight		
182 L	8024648000170	12		Finishing trowels 7/10	48x13 cm	18 7/8"x5 1/8"	600 gr	21.1 oz	49x34xh17 cm	19 1/4"x13 3/8"xh 6 5/8"	7,6 Kg	16.7 lbs
183 L	8024648000262	16		Finishing trowels 6/10	28x12 cm	11"x4 3/4"	340 gr	12 oz	63x30xh12 cm	24 7/8"x11 7/8"xh 4 3/4"	5,8 Kg	12.8 lbs
183 LG	8024648007766	16		Finishing trowels 6/10								
184 LG	8024648003867	6		Finishing trowels 7/10	36x13 cm	14 3/16"x5 1/8"	460 gr	16.2 oz	38x30xh12 cm	15"x12"x h 4 3/4"	3 Kg	6.6 lbs

TRAPEZIAL FINISHING TROWELS (STAINLESS STEEL)

- Stamped in stainless steel AISI420- 6/10 22 guage (1/42").
- Handles are made of polished aluminum electro-welded to the blade with waxed wood handgrips fastened by a non-slip screw.



Part No.	Barcode	Box	Tipo	Description	Blade Dimensions		Weight	Volume	Dimensions	Weight		
142 INX28	8024648007964	12		Finishing trowels 6/10	12x28 cm	4 3/4"x11"	350 gr	12.3 oz	55x30xh 11cm	21 5/8"x11 7/8"xh 4 3/8"	4,5 Kg	9.9 lbs
142 INX24	8024648007957	12		Finishing trowels 6/10	10x24 cm	3 15/16"x9 7/16"	280 gr	9.9 oz		3,7 Kg	8.2 lbs	
142 INX20	8024648007940	20		Finishing trowels 6/10	8x20 cm	3 1/8"x7 7/8"	240 gr	8.5 oz		5,1 Kg	11.2 lbs	



MIXING PADDLES AND BUCKETS



178D60
178389E
178389L
178389F
178389G



289CMAN



289IPER



178D80
178S
178



289CICO



289LT27



MIXING PADDLES FOR MIXING DRILLS

- Hexagonal calibrated arm 10 mm (3/8) with anti-corrosion treatment.
Available in double spiral or 4 spoke shape, with screw or chuck fit.

Part No.	Barcode	Icon	Description	Icon 1	Icon 2	Icon 3	Icon 4	Icon 5	Icon 6
178 389E	8024648009814	1	4-spoke mixing paddle Ø 140 mm (5 3/4")	-	•	-	-	-	-
178 389L	8024648079541	1	Dual spiral mixing paddle Ø 160 mm (6 9/16")	-	•	-	-	-	-
178 389F	8024648017888	1	Dual spiral mixing paddle Ø 140 mm (5 3/4")	-	•	-	-	-	-
178 389G	8024648017895	1	Dual spiral mixing paddle Ø 120 mm (4 3/4")	-	•	-	-	-	-
178 S	8024648000392	10	Dual spiral mixing paddle Ø 90 mm (3 1/2")	-	-	•	-	-	-
178	8024648000385	16	4-spoke mixing paddle Ø 120 mm (4 3/4")	-	-	•	-	-	-
178D60	8024648056887	12	Dual spiral mixing paddle Ø 60 mm (2 3/8")	-	-	•	-	-	-
178D80	8024648058195	12	Dual spiral mixing paddle Ø 80 mm (3 1/8")	-	-	•	-	-	-

BUCKETS

- Made of impact resistant plastic. Resists temperatures down to -5°. The reinforced bottom and rim make it suitable for carrying heavy loads (tile waste etc...).

Part No.	Barcode	Icon	Description	Icon 1	Icon 2	Icon 3	Icon 4	Icon 5	Icon 6
289CMAN	8024648000996	1	Bucket with steel handle	45 lt	12 gal	2,7 Kg	5,9 lbs	-	-
289IPER	8024648000989	1	Bucket with handles	45 lt	12 gal	2,3 Kg	5 lbs	-	-
289CICO	8024648007605	1	Bucket with steel handle	27 lt	7 gal	1,8 Kg	4 lbs	-	-
289LT27	8024648006288	1	Bucket with handles	27 lt	7 gal	1,5 Kg	3,3 lbs	-	-



TOOLS



TOOLS

SHOES	P2
KNEE PADS AND FOAM BOARD	P3
ROLLING SEATS, TROLLEYS AND WORK BENCHES	P4
SUCTION CUPS	P5
SLABS LIFTERS	P6
SCREEDING TOOLS	P7
ANTI-BOUNCE HAMMERS AND HAND TILE BEATER	P8
WOLFRAM CARBIDE DISCS FOR GRINDER AND SCRAPING TOOLS	P9



MEASURING AND LAYOUT TOOLS

ADJUSTABLE SQUARE AND ANGLE GUIDES, STEP-SETTER (FOR SETTING STAIRS) WALL LEVELLING GUIDES	P10
---	-----



In addition to the tools already shown in the previous sections, professional tile installers need many others; such as knee pads, suction cups, trolleys, workbenches, hammers... as well as measuring and layout tools. All carefully designed to provide the professionals the highest efficiency and precision. From the adjustable squares, to the innovative system to set mortar base. And again the very useful wall levelling guides as well as the practical angle guides and the step-setter.

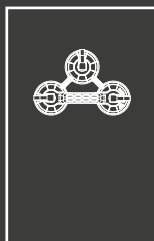

SHOES

MADE IN ITALY



137



137MOLLA



137B



137BMOLLA



137HUSKY



WAFFLED SHOES FOR WALKING ON SET TILE

- Made of impact resistant plastic with a "waffled" (textured) bottom to provide grip and to distribute the wearers weight evenly over the surface.
- The toe-guard is included and designed to accommodate most safety-shoes.
- Available with spring or elastic straps.
- Shoes are perfectly flat in order to distribute weight evenly over the surface.
- Shoe surface measures approximately 20x39 cm (12 square inches).

Part No.	Barcode	Box Icon	Description	Weight (Kg)	Weight (lbs)	Dimensions (cm)	Dimensions (in)	Weight (Kg)	Weight (lbs)
137	8024648000019	10	Tiles shoes with elastic strap (per pair)	1,2 Kg	2.6 lbs	50x43xh 43 cm	19 5/8"x17"xh 17"	13,2 Kg	29.1 lbs
137MOLLA	8024648000026	10	Tile shoes with spring (per pair)	1,3 Kg	2.9 lbs			14,2 Kg	31.3 lbs

SMOOTH SHOES FOR WALKING ON MORTAR BASE

Part No.	Barcode	Box Icon	Description	Weight (Kg)	Weight (lbs)	Dimensions (cm)	Dimensions (in)	Weight (Kg)	Weight (lbs)
137B	8024648000033	12	Shoes for mortar base with elastic strap (pair)	1,1 Kg	2.4 lbs	50x43xh 43 cm	19 5/8"x17"xh 17"	14,4 Kg	31.7 lbs
137BMOLLA	8024648000040	12	Shoes for mortar base with spring (pair)	1,2 Kg	2.6 lbs			15,6 Kg	34.4 lbs

SHOES FOR WALKING ON THE ADHESIVE WHILE SETTING TILES

- Steel bottom, replaceable toe-guard made of nylon. The toe-guard is designed for safety- shoes. Straps to the shoe with a spring strap.

Part No.	Barcode	Box Icon	Description	Weight (Kg)	Weight (lbs)	Dimensions (cm)	Dimensions (in)	Weight (Kg)	Weight (lbs)
137HUSKY	8024648000057	4	Toothed shoes "Husky" (per pair)	1,7 Kg	3.7 lbs	35x27xh 31 cm	14"x10 5/8"x h 12"	7,1 Kg	15.7 lbs

REPLACEMENT PARTS

Part No.	Barcode	Box Icon	Description	Weight (gr)	Weight (oz)	Dimensions (cm)	Dimensions (in)	Weight (gr)	Weight (oz)
196	8024648004888	10	Elastic strap for shoes	20 gr	0.7 oz	-	-	200 gr	7.1 oz
314TR02D	8024648005236	10	Spring with clip	40 gr	1.4 oz	27x15xh 10 cm	10 5/8"x6"xh 4"	400 gr	14.1 oz
137FE01D	8024608011918	20	Elastic strap holder	1 gr	0.04 oz	-	-	20 gr	0.7 oz





138RELAX



138SOFF



138



PACK



BOX



BOX



196GCA



330

MADE IN ITALY



KNEE PADS RELAX-GEL

- Plastic shell: maximum knee protection.
- Gel inner padding.

- Comfort elastic fabric with single strap system.

Part No.	Barcode	Box	Description	Weight	Dimensions	Volume	Weight
138RELAX	8024648062680	12	Knee pads (per pair)	600 gr / 21.1 oz	49x40x34 cm / 19 1/4"x15 3/4"x13 3/8"		7,9 Kg / 17.4 lbs

KNEE PADS WITH RIBBING

- For Knee protection.
- Replaceable soft foam inserts.

- Useful when using sand or mortar (mud bed) layouts. The ribbing flexes with the knee so that the knee pad stays in contact with the leg to prevent sand or other particles from getting in between the knee and knee pad.

Part No.	Barcode	Box	Description	Weight	Dimensions	Volume	Weight
138SOFF	8024648000088	12	Knee pads with ribs (per pair)	610 gr / 21.5 oz	39x35x31 cm / 15 3/8"x13 3/4"x12 1/4"		7,7 Kg / 17 lbs

KNEE PADS

- For knee protection.

- Made of molded polyurethane, in one piece. These knee pads are very durable.

Part No.	Barcode	Box	Description	Weight	Dimensions	Volume	Weight
138	8024648000071	16	Knee pads (per pair)	350 gr / 12.3 oz	39x35x31 cm / 15 3/8"x13 3/4"x12 1/4"		6 Kg / 13.2 lbs

"MORBIDONE" FOAM BOARD

- Made of a single piece of molded polyurethane. This foam knee board solves the problem of knee protection for those who cannot wear straps behind the knees.

Part No.	Barcode	Box	Description	Weight	Dimensions	Volume	Weight
330	8024648000095	5	"Morbidone" Foam knee board	800 gr / 31.7 oz	58x30x25 cm / 22 7/8"x11 3/4"x9 7/8"		4,6 Kg / 10.1 lbs

REPLACEMENT PARTS

Part No.	Barcode	Box	Description	Weight	Dimensions	Volume	Weight
138IM03D	8024648011909	2	Inserts for knee pads with ribs	80 gr / 2.8 oz	27x15x10 cm / 10 5/8"x6"x4"		200 gr / 7 oz
196GCA	8024648064141	10	Fabric band with hooks for knee pads	-	-	-	-



ROLLING SEATS, TROLLEYS AND WORK BENCHES



"NELSON" ROLLING SEAT WITH KNEE PAD

- Comfortable, strong, steady, designed to prevent occupational injuries associated with the knees and back.
- Ideal for adhesive spreading or any other job where being in a stooped/kneeling position for a

period of time is needed.

- Adjustable height from 27 to 35 cm (10" - 13 3/4") to transfer the weight through the seat rather than through the knees.

Part No.	Barcode	Box	Description	Weight	Dimensions	Volume	Weight
383COMBI	8024648015396	1	"Nelson"	10 Kg / 22 lbs	61x43xh 14 cm / 24"x17"xh 5 1/2"		11,4 Kg / 25.1 lbs

"NAPOLEONE" SEAT WITH WHEELS

- Comfortable, strong, steady, prevent back and knee strain by sitting and rolling.
- Adjustable height from 27 to 35 cm (10 5/8" - 13 3/4").
- Facilitates jobs such as skirting or wall tiling up to 80/100 cm (31 3/8" - 40") while sitting

in comfort.

- The "Napoleone's" (5) five wheel design allows it to roll smoothly and comfortably in any direction.

Part No.	Barcode	Box	Description	Weight	Dimensions	Volume	Weight
383TRI	8024648006332	1	"Napoleone"	4 Kg / 8.8 lbs	38x36xh 30 cm / 15x14"xh 11 7/8"		4,7 Kg / 10.4 lbs

"ELIA" BUCKET-HOLDER / TILE DOLLY

- Use with the cover for carrying a bucket or stacks of tile.
- Easy to move on free-spinning wheels (3).

- Use without the cover to tilt the bucket for easier access to the adhesive.

Part No.	Barcode	Box	Description	Weight	Dimensions	Volume	Weight
384TRI	8024648006325	1	"Elia"	3 Kg / 6.6 lbs	40x40xh 15 cm / 15 3/4"x15 3/4"x h 6"		3,4 Kg / 7.5 lbs

TECHNICAL CHARACTERISTICS



"PUGIOL" WORK BENCH

- Useful as a work bench and also as a platform due to the strong steel frame.
- Stand folds down for easy transport.

- Work bench size: 45x77xh 74 cm (17 3/4"x30 1/8"xh 29").
- Dimensions in transport position: 100x45xh 11 cm (40"x17 3/4"xh 4 3/8").

Part No.	Barcode	Box	Description	Weight	Dimensions	Volume	Weight
394	8024648003645	1	"Pugiol"	9 Kg / 19.8 lbs	100x50xh 12 cm / 40"x20"xh 4 3/4"		10 Kg / 22 lbs

MODULAR BENCH WITH FOLDING LEGS : BM180^{MkII} AND BM180 PLUS

- Both equipped with folding legs to put the product in transport configuration quickly and easily.
- The steel structure and the worktop made of anodized aluminum profiles guarantee sturdiness and stability.
- Both with legs provided with adjustable rubber feet.
- Both provided with adjustable anodized aluminum profiles.

- BM180^{MkII}: height: 83 cm (32 3/4"). Max load: 150 Kg (331 lbs). Worktop dimensions: 180 x 90 cm (3'x6").
- BM180 PLUS: height: 83 cm (32 3/4"). Max load: 150 Kg (331 lbs). Width: from 100 cm (3.2') up to 150 cm (4.9').

TECHNICAL CHARACTERISTICS



Part No.	Barcode	Box	Description	Weight	Dimensions	Volume	Weight
394MA RAI	8050532000995	1	"BM180 ^{MkII} " - modular bench with folding legs	31 Kg / 68.3 lbs	117x20xh 20 cm + 190x21x h 10 cm / 46"x8"x h 8" + 75"x8"x h 14"		35 Kg / 77 lbs
394MA PLUS	8050532007062	1	"BM180 PLUS" - modular bench width 100-150 cm with folding legs	38 Kg / 83.7 lbs	117x20xh 20 cm + 190x21x h 10 cm / 46"x8"x h 8" + 75"x8"x h 14"		39,8 Kg / 87.7 lbs





185



185BI



185TRI

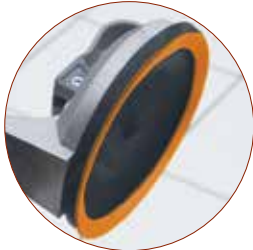

140FU03D



185V150CS



185V150VCS



SUCTION CUP

- Ergonomic grip with lever for one handed use (down = suction, up = release).
- Maximum lifting load 40 Kg – 88 lbs (on clean and smooth surfaces).

- Ø 115 mm (4 1/2") rubber cup with welded metallic pin.
- Grey stain-free rubber.

Part No.	Barcode	Box	Description	Weight	Volume	Dimensions	Weight	Volume	
185	8024648000354	10	"Medusa"	350 gr	12.3 oz	35x35xh 14 cm	13 3/4"x13 3/4"xh 5 1/2"	3,8 Kg	8.4 lbs

DOUBLE SUCTION CUPS

- Made of cast aluminum.
- Ø 115 mm (4 1/2") rubber cups with welded metallic pin.

- Maximum lifting load 90 Kg (198 lbs) on clean and smooth surfaces.
- Grey stain-free rubber.

Part No.	Barcode	Box	Description	Weight	Volume	Dimensions	Weight	Volume	
185BI	8024648000361	5	Double suction cup	900 gr	31.7 oz	35x35xh 14 cm	13 3/4"x13 3/4"xh 5 1/2"	4,8 Kg	10.6 lbs

TRIPLE SUCTION CUPS

Made of cast aluminum. Ø 115 mm (4 1/2") rubber cups with welded metallic pin. Maximum lifting load 140 Kg (309 lbs) on clean and smooth surfaces.

Part No.	Barcode	Box	Description	Weight	Volume	Dimensions	Weight	Volume	
185TRI	8024648000378	3	Triple suction cup	1,2 Kg	2.6 lbs	35x35xh 14 cm	13 3/4"x13 3/4"xh 5 1/2"	4 Kg	8.8 lbs

FOAM WASHER – FOR TEXTURED SURFACES

- Self-adhesive foam washer: if stuck under the cup it increases the hold on rough surfaces.

Part No.	Barcode	Box	Description	Weight	Volume	Dimensions	Weight	Volume	
140FU03D	8024608011932	1	H 2 mm-3/32" self-stick washer	10 gr	0.35 oz	-	-	100 gr	3.5 oz

VACUUM SUCTION CUPS

- It grants a tight grip even on textured materials.
- Equipped with manual pump to create vacuum as well as an indicator that shows when the suction is losing grip.
- Equipped with release button.
- It comes in a case for protection during transport and storage.
- Cup Ø 150 mm.
- The version with vacuum gauge guarantees a precise and constant monitoring and advises the user when it is necessary to restore the vacuum.

Part No.	Barcode	Box	Description	Weight	Volume	Dimensions	Weight	Volume	
185V150CS	8024648086945	1	Vacuum suction cup Ø 150 mm with case	1,45 Kg	3.2 lbs	39x39xh15 cm	15 3/8"x15 3/8"xh 6"	1,8 Kg	4 lbs
185V150VCS	8024648095861	1	Vacuum suction cup Ø 150 mm with gauge with case	1,56 Kg	3.4 lbs			1,9 Kg	4.2 lbs



SLABS LIFTERS

MADE IN ITALY



144

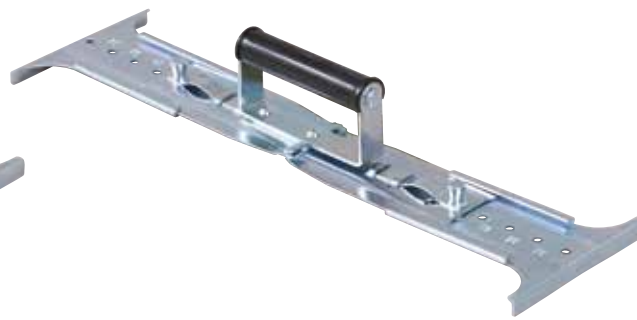

144CM50-65



144CM50-120



SLAB LIFTER (MAX EXTENSION 50 cm)

- To lift and lay tiles and large stone, such as terrazzo, etc..
- To facilitate lifting and reduce stress to the hands and fingers.

- For sizes of: 30-35-40-45-50 cm (11 7/8"-13 3/4"- 15 3/4" - 17 3/4" - 19 5/8").

EXTENDING SLAB LIFTERS 50-65

- For handling and laying large format slabs (max 65x65 cm - 25 1/2") with high thickness and structured surfaces.
- Variable extension from 50 to 65 cm (19 5/8" to 25 1/2").

- Sturdy and reliable galvanized steel structure.
- Minimum required joint: 3 mm (1/8").

EXTENDING SLAB LIFTERS 50-120

- For handling and laying large format slabs (max length 120 cm - 47 1/4") with high thickness and structured surfaces.
- Variable extension from 50 to 120 cm (19 5/8" to 47 1/4").

- Sturdy and reliable structure made of aluminum and steel.
- Double handle.
- Minimum required joint: 3 mm (1/8").

Part No.	Barcode	Quantity	Description	Weight (Kg)	Weight (lbs)	Dimensions (cm)	Dimensions (in)	Weight (Kg)	Weight (lbs)
144	8024648000347	10	Slab lifter	1,1	2.4	40x40 xh 15	15 3/4"x15 3/4"xh 6"	11,4	25.1
144CM50-65	8024648084871	2	Extension for slab lifter 50/65 cm	2	4.4	71x23xh 12	28"x9"xh 4 3/4"	4,3	9.5
144CM50-120	8024648084750	2	Extension for slab lifter 50/120 cm	4,4	9.7	117x20xh 20	46"x8"xh 8"	10,2	22.5





TEMPERED STEEL MORTAR SPREADER

- To spread cement and sand screed, asphalt, sand mixtures etc... • Strong and light. Can be used with aluminum pole 133-178 cm (70" - 52").

Part No.	Barcode	Box	Description	Diagram	Weight	Volume	Dimensions	Weight
141PASQ	8024648000972	12	Steel mortar spreader without pole	55 cm 21 5/8"	820 gr 28.9 oz	58x30xh 25 cm	23"x12"xh 10"	10,3 Kg 22.7 lbs

ANODIZED ALUMINUM POLE

- Superior strength, available in multiple lengths. Sectional version also available.

Part No.	Barcode	Box	Description	Ø	Diagram	Weight	Volume	Dimensions	Weight
197180CM	8024648000644	12	With hole	27 mm	178 cm 70"	600 gr 21.2 oz	180x25xh 25 cm	70"x10"xh 10"	7,7 Kg 17 lbs
197CF	8024648000316	12	With hole	1/16"	133 cm 52"	420 gr 14.8 oz	140x25xh 9 cm	55"x10"xh 3 1/2"	5,5 Kg 12.1 lbs
197SC	8024648014511	12	Sectional with hole			530 gr 18.7 oz	71x23xh 15 cm	28"x9"xh 6"	6,7 Kg 14.8 lbs

"SLITINO" STEEL SLIDE KIT

- Kit of 4 steel slides, 1500x50x5/10 mm (4'1"x2"x 9/16").
- To be laid on reference strips to make up the screed rails, creates a straight, smooth surface for the level or screed to slide on.

Part No.	Barcode	Box	Description	Diagram	Weight	Volume	Dimensions	Weight
145SLITTA	8024648004635	1	Slides for screed (kit 4 pcs)	150 cm 59"	1,1 Kg 2.4 lbs	31x31xh 5 cm	12 1/4"x12 1/4"xh 2"	1,3 Kg 2.9 lbs

"KESSLER" HANDLES FOR STRAIGHT EDGE / LEVELS

- Now you can put a pair of "handles" on your straight edge or level. A unique way to give your old straight edge, screed bar, or level, an ergonomic upgrade.
- For straight levels of minimum height of 50 mm (2") and thickness from 15 to 35 mm (5/8" - 1 3/8").

Part No.	Barcode	Box	Description	Weight	Volume	Dimensions	Weight
421	8024648007124	1	"Kessler" (pair)	900 gr 35 oz	-	-	2 Kg 4.4 lbs

SHEATH-PRESSER

- Roll for easy, fast, and even, laying of preformed membrane laid with adhesive.
- Height-adjustable-shaft provided with double handles.
- Available also the version for use on wall or small areas (art. 232 WALL R).

Part No.	Barcode	Box	Description	Weight	Volume	Dimensions	Weight
232RAI	8024648073587	4	Sheath-presser-roller	5,8 Kg 12.8 lbs	135x42xh 28 cm	53"x16 1/2"xh 11"	26,7 Kg 58.9 lbs
232WALL R	8024648097415	4	Sheath-presser-roller for wall	0,7 Kg 1.5 lbs	20x21xh 5 cm	8x8 1/4"xh 2"	7.7 Kg 3,5 lbs



ANTI-BOUNCE HAMMERS AND HAND TILE BEATERS



1761KGBC



176500BC



142



142G

PACKAGE



CARTON BOX

WHITE, NON-MARRING RUBBER MALLET

- The white non-marring rubber leaves no mark on the tile.
- All mallets are balanced to reduce stress to the wrists.
- Molded in a single-piece, the handle is reinforced with a steel core for superior strength.

Part No.	Barcode	Box	Description	Weight	Dimensions	Volume	Weight	
1761KGBC	8024648098122	8	White rubber mallet	1 Kg	2.2 lbs	40x32xh 12 cm	15 3/4"x12 5/8"xh 4 3/4"	8,5 Kg 18.7 lbs
176500BC	8024648098139	12	White rubber mallet	500 gr	17.6 oz	40x32xh 12 cm	15 3/4"x12 5/8"xh 4 3/4"	6,5 Kg 14.3 lbs

PLASTIC TILE BEATER

- Prevents tile lippage and ensures adequate bond between tile and adhesive.
- Plastic construction does not warp with humidity.
- Grooved, flat base prevents suctioning so the beater does not stick to the tile.
- The off-set handle provides a larger striking surface. Depth: 15 mm (5/8").

Part No.	Barcode	Box	Description	Weight	Dimensions	Volume	Weight	
142	8024648000910	6	Plastic tile beater	1,5 Kg	3.3 lbs	17x37 cm 6 1/2"x14 1/2"	40x40xh 15 cm 15 3/4"x15 3/4"xh 6"	9,4 Kg 20.7 lbs

RUBBER ANTI-BOUNCING TILE BEATER

- To improve adhesive bonding and to expel air from underneath the slabs/tiles.
- Rubber bottom to prevent tiles/slabs damages.
- Sturdy metal framework.
- The off-set handle increases effectiveness.

Part No.	Barcode	Box	Description	Weight	Dimensions	Volume	Weight	
142G	8024648078582	6	Rubber tile beater	1,9 Kg	4.2 lbs	145x350 mm 5 3/4"x13 3/4"	40x40xh 15 cm 5 3/4"x12 5/8"xh 4 3/4"	11,4 Kg 25.1 lbs





PACKAGE



WOLFRAM CARBIDE DISCS FOR GRINDER

• Suitable for: cement, wood, bricks, plastic plaster, marble, tiles, adhesive, plastic, fibreglass, rust, paints,,etc.

- Performance: last 150 times more than sand paper. Working times: reduced to 30/50% when compared to sandpaper.
- It does not get easily blocked. It gets simply cleaned with a steel-wire brush.

Part No.	Barcode	Box	Description	Ø	Grain	Weight	Box Dimensions	Weight
273D115 W14	8024648074751	1	Wolfram carbide discs for grinder	115 mm 4 1/2"	14	0,3 Kg 10,6 oz	-	-
273D115 W24	8024648074768	1	Wolfram carbide discs for grinder		24			
273D115 W36	8024648074775	1	Wolfram carbide discs for grinder		36			
273D125 W14	8024648074782	1	Wolfram carbide discs for grinder	125 mm 5"	14	0,27 Kg 9,5 oz	-	-
273D125 W24	8024648074799	1	Wolfram carbide discs for grinder		24			
273D125 W36	8024648074805	1	Wolfram carbide discs for grinder		36			
273D180 W14	8024648074812	1	Wolfram carbide discs for grinder	180 mm 7"	14	0,5 Kg 17,6 oz	-	-
273D180 W24	8024648074829	1	Wolfram carbide discs for grinder		24			
273D180 W36	8024648074836	1	Wolfram carbide discs for grinder		36			

"FAKIRO" PLASTER RASP

• To remove irregularities on the plaster surface prior to finishing.

Part No.	Barcode	Box	Description	Dimensions	Weight	Box Dimensions	Weight
347RAS480	8024648015402	9	"Fakiro" Plaster Rasp 480 V	25x14,5 cm 10"x5 3/4"	400 gr 14.1 oz	40x40xh 15 cm 15 3/4"x15 3/4"xh 6"	4 Kg 8.8 lbs
347RIC480U	8024608059307	24	Replacement blades	25x14,5 cm 10"x5 3/4"	300 gr 10.6 oz	33x33xh 10 cm 13"x13"xh 3 5/16"	7,6 Kg 16.8 lbs

SCRAPER WITH STEEL BLADE

To remove adhesive, paint, etc... waste. Can be pole mounted to be used in a standing position.

Part No.	Barcode	Box	Description	Scraper Blade Size	Weight	Box Dimensions	Weight
347 10	8024648000699	10	"Ginetto" steel blade scraper	10 cm 4"	260 gr 9.2 oz	33 x 33 xh 10 cm 13"x13"xh 3 5/16"	3 Kg 6.6 lbs
347 15	8024648000705	10	"Ginetto" steel blade scraper	15 cm 6"	320 gr 11.3 oz		3,6 Kg 7.9 lbs
347 20	8024648000712	10	"Ginetto" steel blade scraper	20 cm 8"	380 gr 13.4 oz		4,2 Kg 9.3 lbs
347 25	8024648000729	8	"Ginetto" steel blade scraper	25 cm 10"	440 gr 15.5 oz		3,9 Kg 8.6 lbs

ANODIZED ALUMINUM POLE

• Superior strength, available in multiple lengths. Sectional version also available.

Part No.	Barcode	Box	Description	Ø	Length	Weight	Box Dimensions	Weight
197180CM	8024648000644	12	With hole	27 mm 1 1/8"	178 cm 70"	600 gr 21.2 oz	180x25xh 9 cm 70"x10"xh 10"	7,7 Kg 17 lbs
197CF	8024648000316	12	With hole		133 cm 52"	420 gr 15.1 oz	140x25xh 9 cm 55"x10"xh 3 1/2"	5,5 Kg 12.1 lbs
197SC	8024648014511	12	Sectional with hole		133 cm 52"	530 gr 18.7 oz	71x23xh 25 cm 28"x9"xh 6"	6,7 Kg 14.8 lbs



MADE IN ITALY

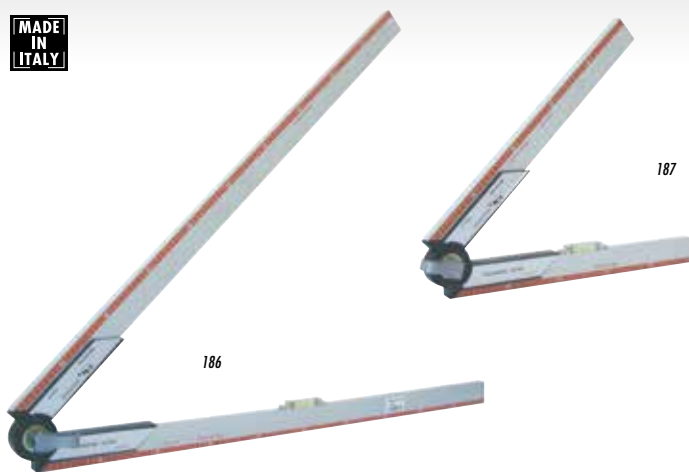

PACKAGE
CARTON BOX

LEVEL PLUMB JOINTED SQUARE

- This is truly a one of a kind level. There are positive stops at 0°/45°/90°/135°/180° all on one level.
- The unique design allows this level to be folded in half for convenient storing.

- 45° position for laying out diagonal floors.
- 90° position for setting square on floors or to check the plumb.
- 180° position to check the level and to take measurements (item 186 up to 200 cm - 6' 6 3/4"; item 187 up to 100 cm - 3' 3 3/8").

Part No.	Barcode	Box	Item	Weight	Dimensions	Weight	Dimensions	Weight	Dimensions
186	8024648000859	1	100 cm	1,2 Kg	3' 3 3/8"	2,6 lbs	102x12xh 6 cm	1,4 Kg	3.1 lbs
187	8024648000866	1	50 cm	800 gr	1' 7 11/16"	28.2 oz	52x12xh 6 cm	800 gr	28.2 oz

DIAGONAL - ALL ANGLE GUIDE

- The easy and accurate way to measure the angle and size of cuts when laying out diagonal floors.

- Especially helpful where walls/rooms are out of square.
- The sliding bar allows measurements to be taken into corners.

Part No.	Barcode	Box	Description	Weight	Dimensions	Weight	Dimensions	Weight	Dimensions
252 50	8024648000897	5	Diagonal 50	1,15 Kg	19 5/8"	2.5 lbs	-	-	-

SPEED - STAIRS SETTER

- For fast and accurate setting of steps.
- They replace the use of the bricks, prevents the movement of the tread and the riser.
- The 90° upright keeps the riser in the desired position.
- The graduated and sliding staffs show the projection of the tread over the riser.

- Can be used for tread depth of 5 to 55 mm (from 7/32" to 2 1/8").
- Only useful for monolithic tread and with lowest projections 25 mm (1").

Part No.	Barcode	Box	Description	Weight	Dimensions	Weight	Dimensions	Weight	Dimensions
171	8024648000941	8	Speed (pair)	1,5 Kg	3.3 lbs	38x36xh 30 cm	15"x14"xh 12"	13 Kg	28 lbs

KRICK KROCK- WALL LEVELLING GUIDES

- Replaces traditional methods such as tacking in supports or shimming with tile etc....
- Precise "micrometric" adjusting knobs allow you to level your first row of tiles quickly and accurately.
- Especially useful in high moisture areas where a waterproofing membrane is being used and cannot be

- punctured.
- Especially useful where the floor has slope so that is not possible to start laying directly from the floor.
- Maximum extension 30 cm (12").

Part No.	Barcode	Box	Description	Weight	Dimensions	Weight	Dimensions	Weight	Dimensions
131 1	8024648000958	3	Krick Krock	700 gr	24.7 oz	33x33xh 10 cm	13"x13"xh 4"	2,5 Kg	5.5 lbs



TOOLS