

| N A T I V E |

ABK

EMOZIONI IN SUPERFICIE

| N A T I V E |

EBONY | P 06

FOREST | P 12

ASH | P 18

RED | P 24

FOG | P 30

ELEGANTE E RICERCATA,
NATIVE ABK È ISPIRATA AL
FASCINO PRIMITIVO DEI
PORFIDI ESTRATTI FRA LE
MONTAGNE TARENTINE.
UNA PIETRA AD EFFETTO
AGGLOMERATO DAL
PARTICOLARE CROMATISMO,
CHE SI DISTINGUE PER LA
TEXTURE OMOGENEA E
GARBATA.

ELEGANT AND SOPHISTICATED,
NATIVE FROM ABK IS INSPIRED
BY THE PRIMORDIAL APPEAL OF
PORPHYRY QUARRIED FROM
THE MOUNTAINS OF ITALY'S
TARENTINO REGION. IT IS AN
AGGLOMERATE-EFFECT STONE
WITH AN UNUSUAL COLOUR
THAT STANDS OUT FOR ITS
SUBTLE, HOMOGENEOUS
TEXTURE.

| NATIVE |

SIZES AND COLORS

LASTRE IN GRES PORCELLANATO A MASSA COLORATA
FULL BODY COLORED PORCELAIN SLABS

6 mm 12 mm



160x320
64"x128"

WIDE
SUPERSIZE SLABS

GRES PORCELLANATO A MASSA COLORATA
FULL BODY COLORED PORCELAIN TILES

9 mm



120x120
48"x 48"



60x120
24"x 48"



30x120
12"x 48"



80x80
32"x 32"



60x60
24"x 24"



30x60
12"x 24"

GRES PORCELLANATO A MASSA COLORATA
FULL BODY COLORED PORCELAIN TILES

OUTDOOR R11

20 mm



90x90
36"x 36"

9 mm



60x60 GRIP
24"x 24"



30x60 GRIP
12"x 24"

volumes
NATIVE

wall
INTERNO 9

table
CROSSROAD
CHALK



| NATIVE |

COLOR TABLE

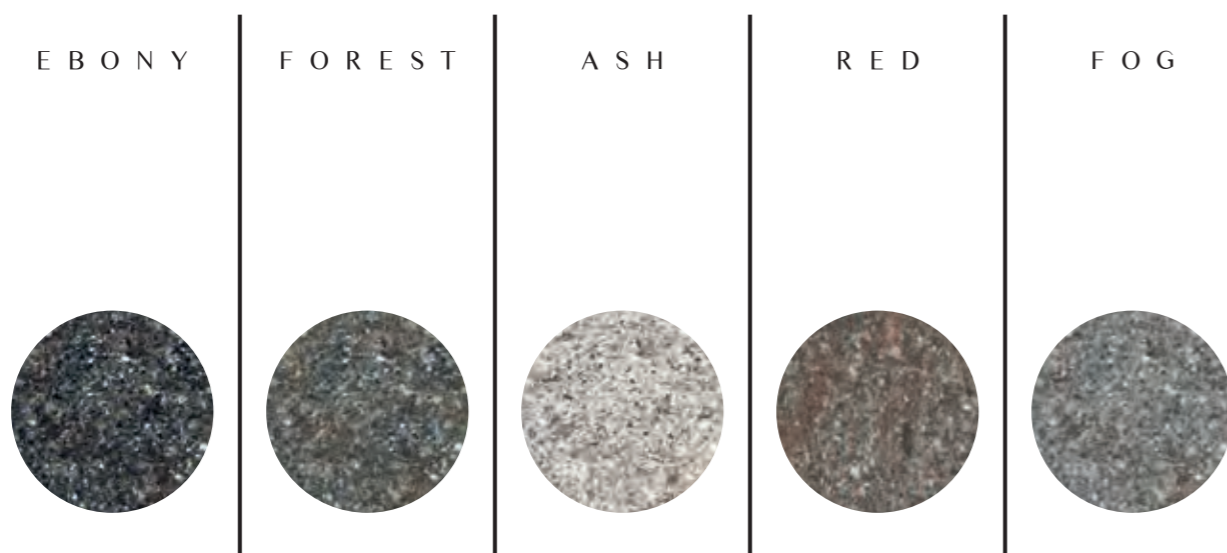

ABK in collaborazione con OIKOS suggerisce una selezione di colori murali per valorizzare al massimo gli spazi NATIVE.
Per maggiori informazioni sui prodotti OIKOS INTERIOR consultare il sito www.oikos-group.it.

ABK has teamed up with OIKOS to offer a selection of wall colours recommended for enhancing the aesthetics of NATIVE spaces.
For further information on OIKOS INTERIOR products, visit the website www.oikos-group.it.



MATCHING MATERIALS

Attraverso le molteplici ispirazioni offerte dalla gamma ABK, è possibile personalizzare ogni ambiente donandogli una sensazione materica sempre differente.
Pietra, cemento, marmo, metallo, legno e pattern si combinano sapientemente tra loro, dando vita a sorprendenti contaminazioni stilistiche per architetture estremamente contemporanee.

The many inspirations behind the ABK range can be used to customise any space and create constantly changing material effects.
Stone, concrete, marble, metal, wood and pattern are skilfully combined to create a surprising crossover style ideal for highly contemporary architectural solutions.



NATIVE + WIDE&STYLE



NATIVE + NEST + CROSSROAD CHALK

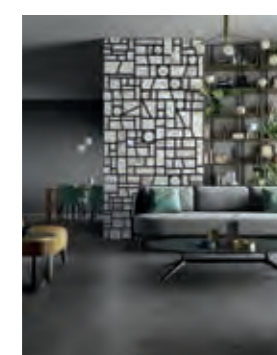

OIKOS INTERIOR ID3085

NATIVE EBONY P 09



OIKOS INTERIOR IN123

NATIVE FOREST P 14



OIKOS INTERIOR ID3095

NATIVE ASH P 20

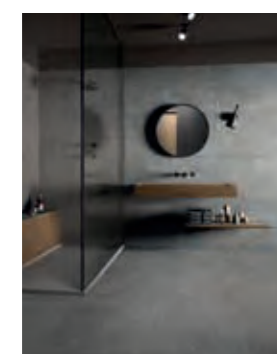

OIKOS INTERIOR ID3075

NATIVE FOG P 33



OIKOS INTERIOR IN672

NATIVE EBONY P 10



OIKOS INTERIOR IN521

NATIVE FOG P 35



NATIVE + SENSI + LAB325



NATIVE + CROSSROAD CHALK + INTERNO 9

E B O N Y



wall
WIDE&STYLE
INCERTUM LIGHT 160x320

floor
NATIVE
EBONY 60x120 lapp.

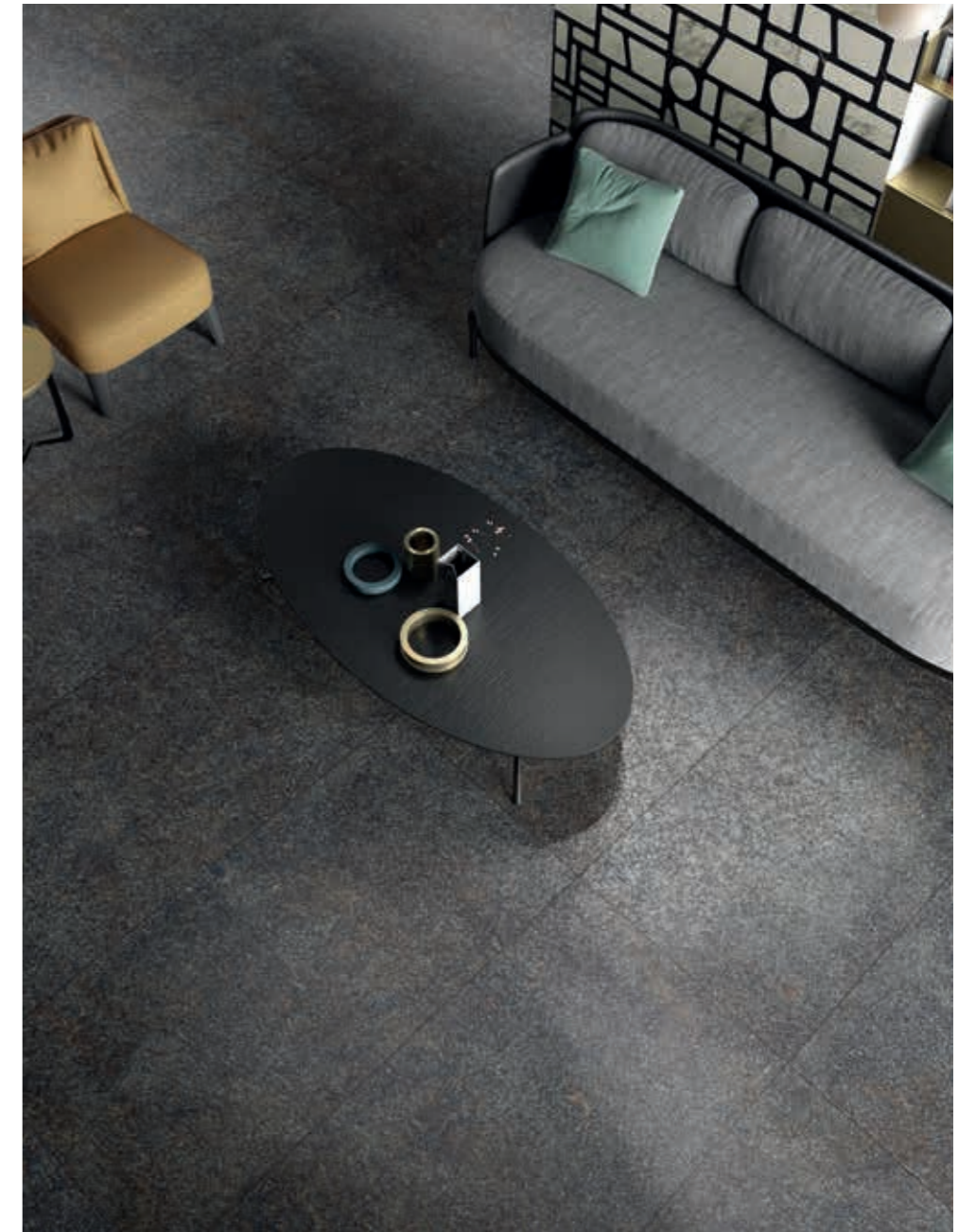



| 10

wall
WIDE&STYLE
INCERTUM LIGHT 160x320

floor
NATIVE
EBONY 60x120 lapp.





wall
CROSSROAD
CHALK COAL 120x240

floor
NATIVE
EBONY 120x120
gradone jolly 40x120x20



wall
NATIVE
EBONY MARK 60x120

floor
NEST
OAK 20x120

washbasin
CROSSROAD
CHALK GREY

washbasin top
NEST
OAK 20x120

F O R E S T



floor
NATIVE
FOREST 80x80

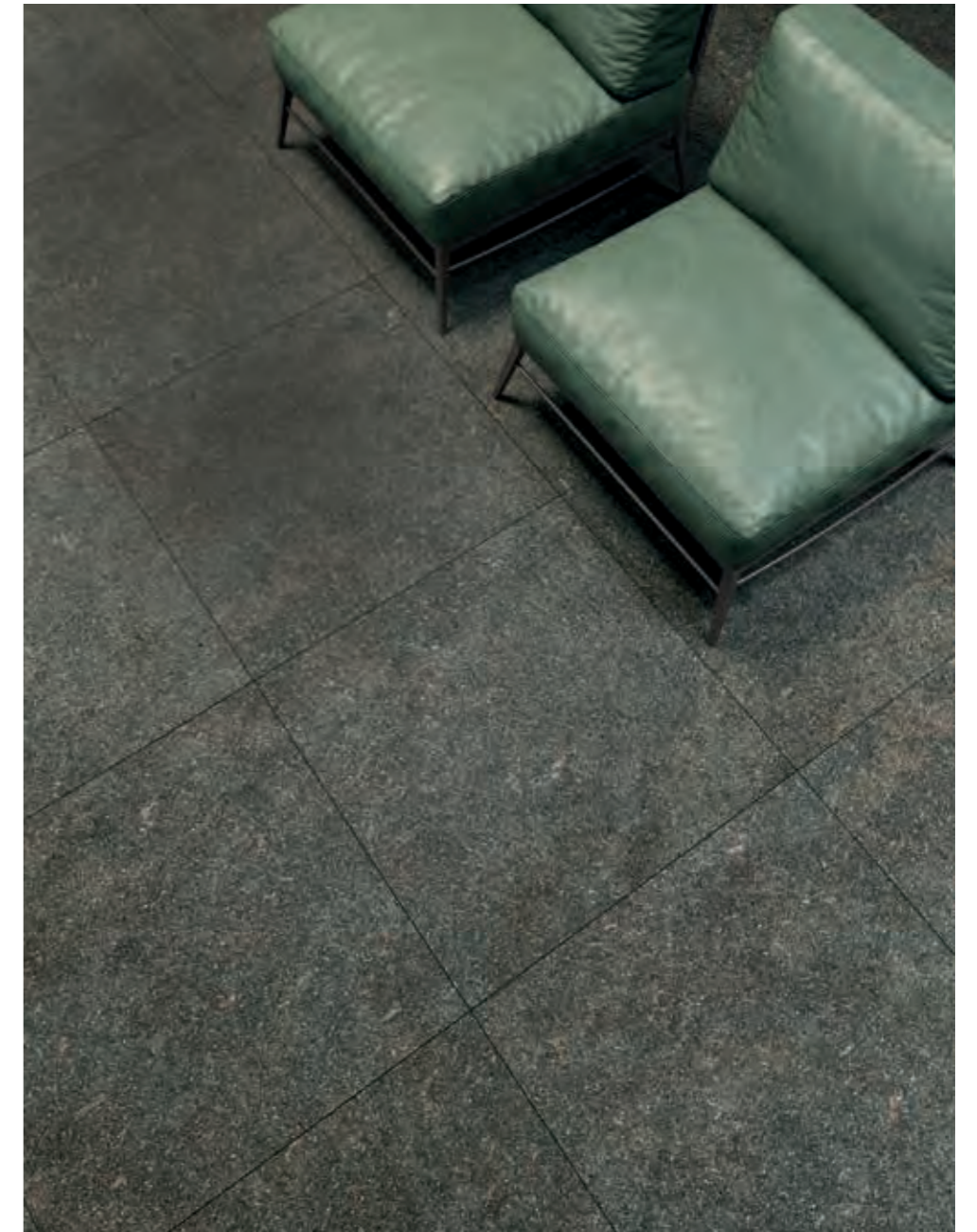

wall
WIDE&STYLE
RAIN FOREST 160x320

PLAY
OXIDE JADE 20x20

floor
NATIVE
FOREST 80x80

volumes
LAB325
BASE PEPPER





wall
WIDE&STYLE
RAIN FOREST 160x320

play
OXIDE JADE 20x20

floor
NATIVE
FOREST 80x80

volumes
LAB325
BASE PEPPER

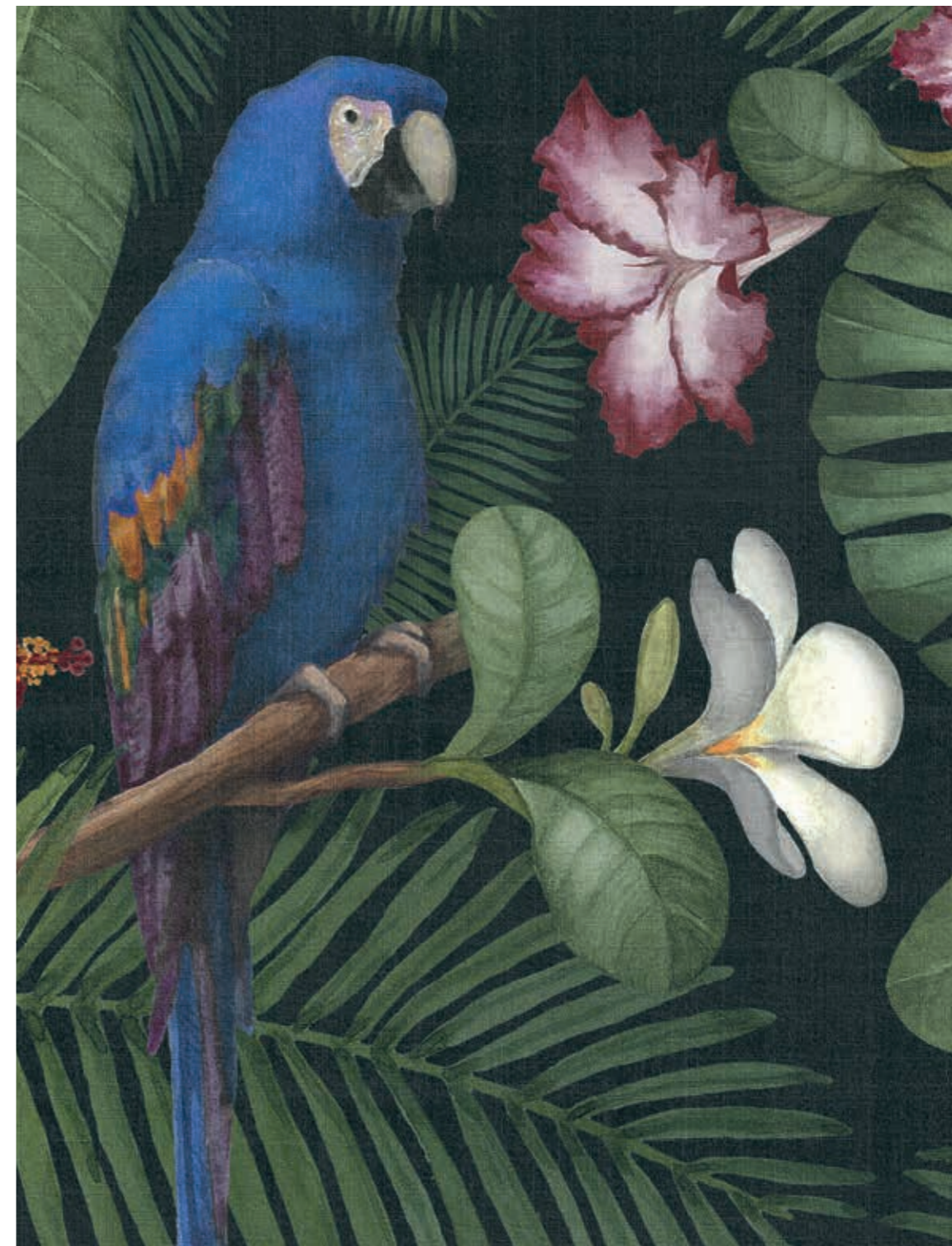

A S H



wall
NATIVE
ASH 120x120

floor
NATIVE
ASH 120x120

outdoor floor
NATIVE
ASH 90x90 20 mm

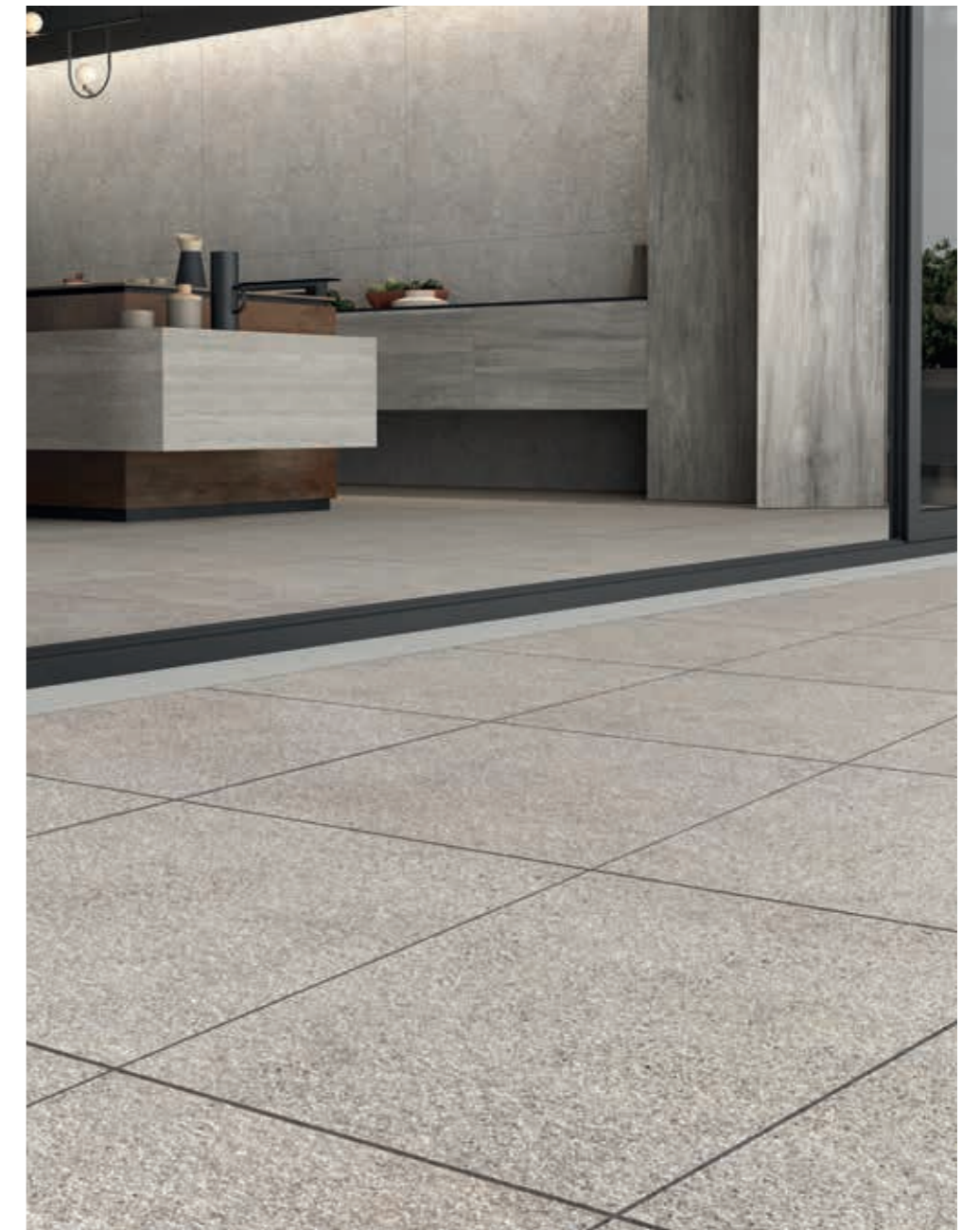

wall
NATIVE
ASH 120x120

floor
NATIVE
ASH 120x120

outdoor floor
NATIVE
ASH 90x90 20 mm

kitchen volume
INTERNO 9
RUST
LAB325
FORM ASH

kitchen top
INTERNO9
RUST 160x320 12 mm



wall
NATIVE
ASH 120x120

floor
NATIVE
ASH 120x120

outdoor floor
NATIVE
ASH 90x90 20 mm

kitchen volume
INTERNO 9
RUST
LAB325
FORM ASH

kitchen top
INTERNO9
RUST 160x320 12 mm



R E D



| 26



floor
NATIVE
RED 120x120



| 27



wall
LAB325
METAL ASH 120x270

floor
NATIVE
RED 120x120

table
SENSI
CALACATTA LUX+ 160x320 12 mm/7 mm





wall
NATIVE
RED 160x320

floor
NATIVE
RED 90x90 20 mm



F O G



floor
NATIVE
FOG 60x120

TABLE
SENSI UP
INVISIBLE PEARL LUX+ 160x320 12 mm

stairs
LAB325
BASE PEPPER





| 34

wall
NATIVE
FOG 30x120
FOG MARK 30x120

floor
NATIVE
FOG 60x120

washbasin and vanity top
INTERNO 9
RUST

shower wall and tray
CROSSROAD
CHALK SMOKE 120x240



| 35



wall
LAB325
BASE ASH 120x270

floor
NATIVE
FOG 120x120

table
LAB325
BASE ASH 160x320 12mm





floor
NATIVE
FOG 90x90 20mm

| NATIVE |

SOLUTIONS



wall
WIDE&STYLE
SECRET GARDEN WALL 160x320

floor
NATIVE
ASH 60x120 lapp.



wall
NATIVE
ASH 30x120

floor
LAB 325
BASE PEARL 60x120

washbasin and top
NATIVE
ASH

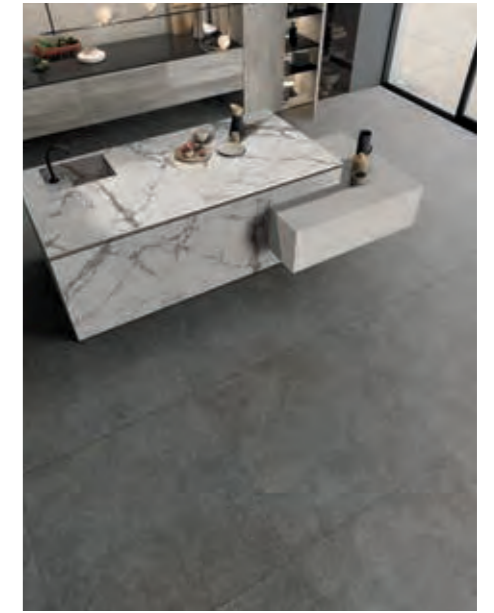

volume
SENSI UP
INVISIBLE PEARL 160x320 12mm/7mm
CROSSROAD CHALK GREY

floor
NATIVE
FOREST 120x120



wall
LAB325
METAL ASH 120x270

floor
NATIVE
FOG 120x120

table
INTERNO 9
RUST 160x320 12mm/7mm



wall
NATIVE
ASH 30x120

floor
NATIVE
EBONY 60x120

washbasin and vanity top
and shower tray
INTERNO 9
SILVER

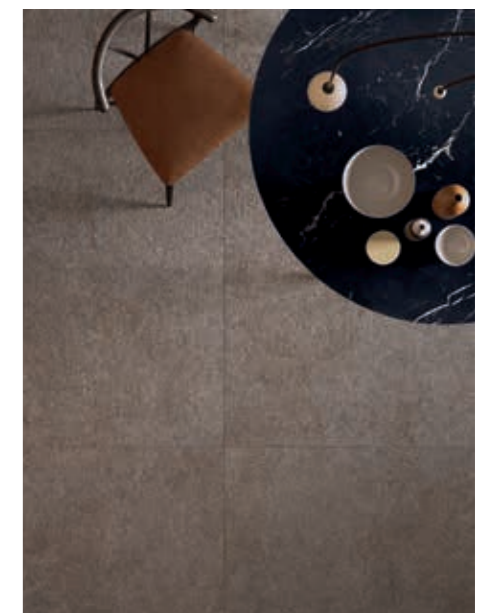

floor
NATIVE
RED 120x120

table
SENSI UP
MARQUINIA 160x320 12mm

EBONY

120x120 rett.	0003773
120x120 lapp.	0004044
60x120 rett.	0003908
60x120 lapp.	0003928
30x120 rett.	0003913
80x80 rett.	0003923
60x60 rett.	0004964
30x60 rett.	0004965

9 mm

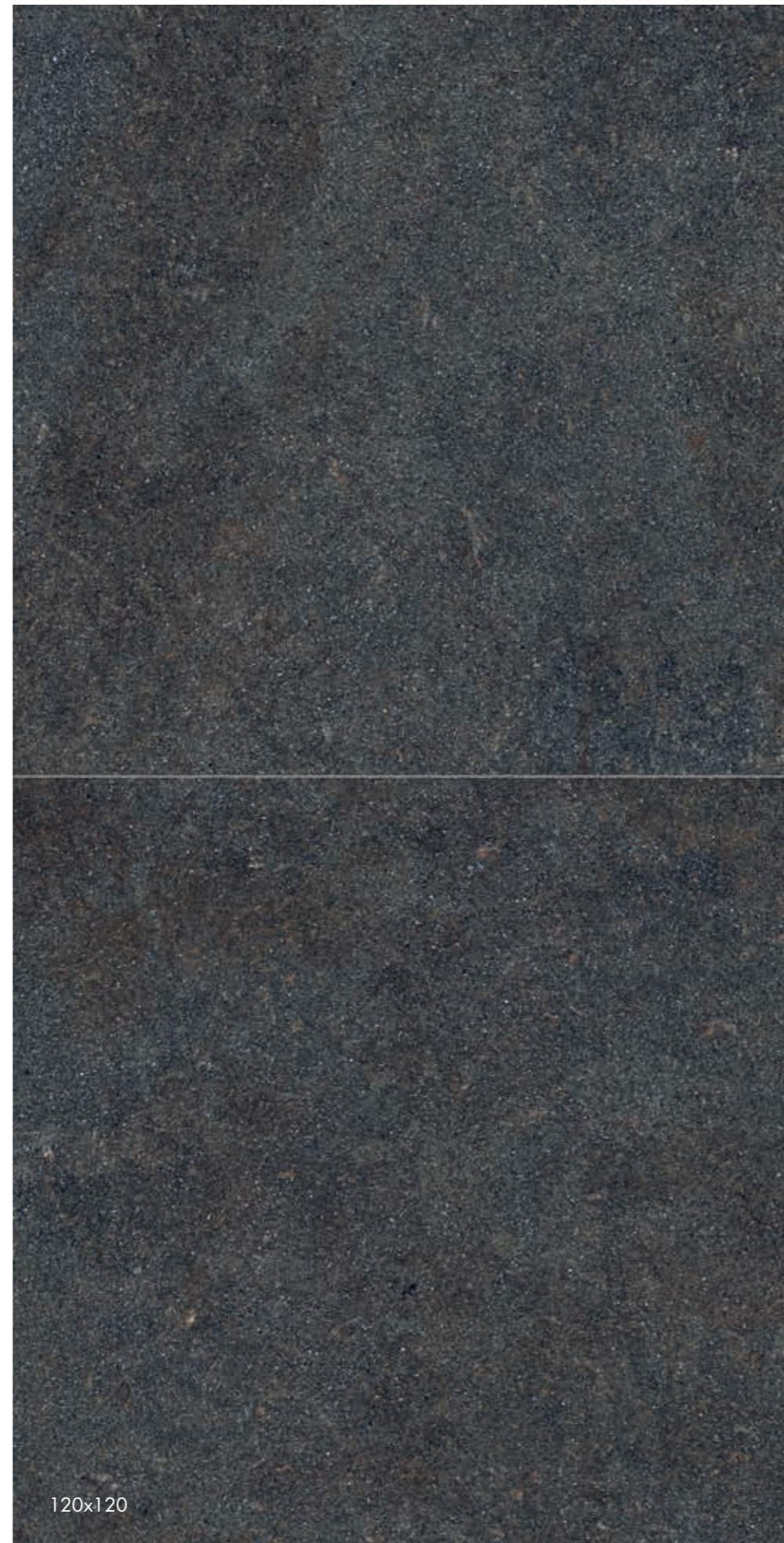

120x120

FOREST

120x120 rett.	0003770
120x120 lapp.	0004041
60x120 rett.	0003905
60x120 lapp.	0003925
30x120 rett.	0003910
80x80 rett.	0003920

9 mm

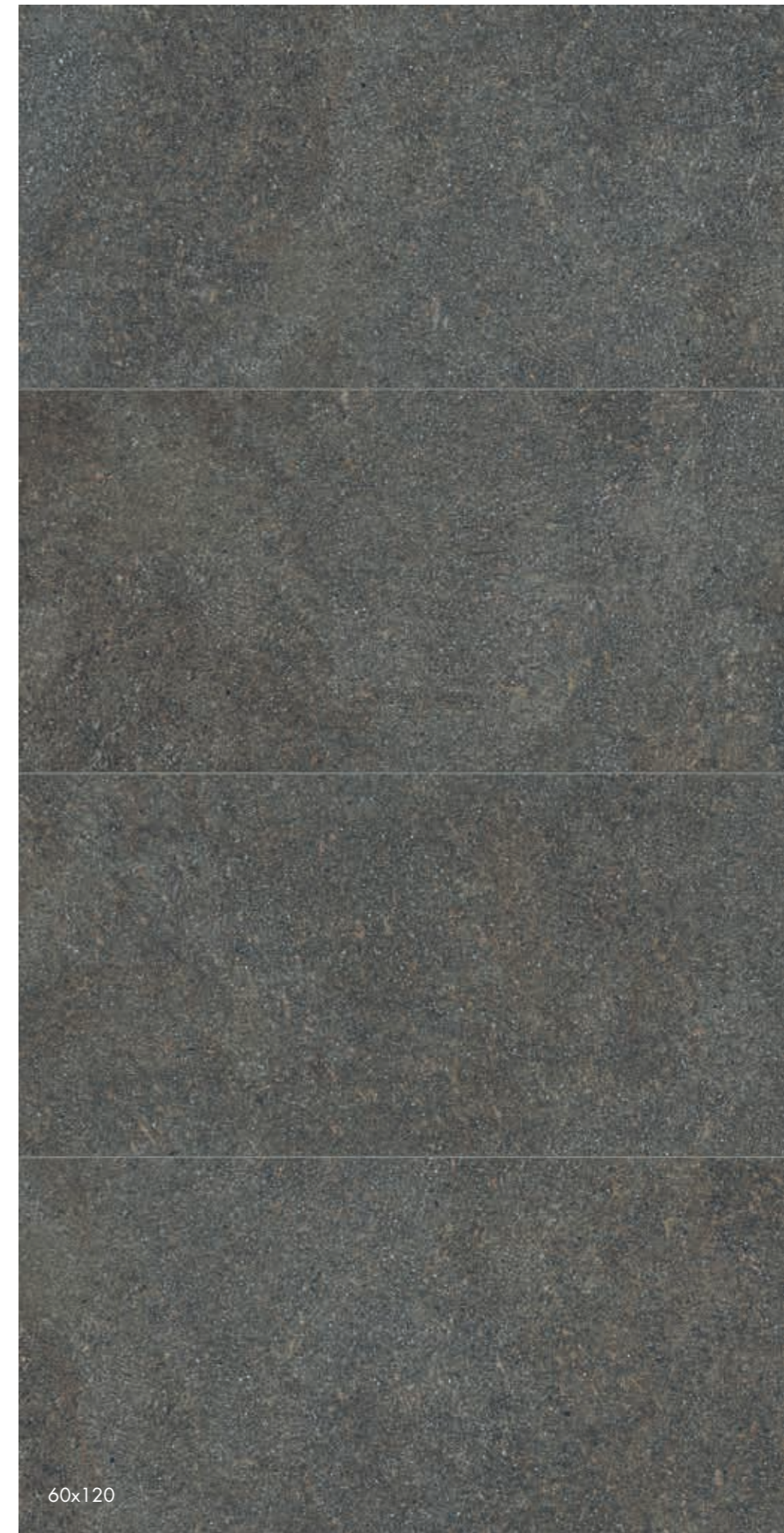

60x120

40

BATTISCOPA rett. 5,5x60 ⌀ 10	0004966	
BATTISCOPA rett. 5,5x80 ⌀ 8	0003937	
GRADONE TOP rett. 32x120x4,5x2 ⌀ 1	0003947	
ANG. TOP SX rett. 32x120x4,5x2 ⌀ 1	0003952	
ANG. TOP DX rett. 32x120x4,5x2 ⌀ 1	0003957	
GRADONE JOLLY rett. 40x120x20 ⌀ 1	0003962	
BATTISCOPA lapp. 5,5x120 ⌀ 6	0003942	
GRADONE TOP lapp. 32x120x4,5x2 ⌀ 1	0004122	
ANG. TOP SX lapp. 32x120x4,5x2 ⌀ 1	0004127	
ANG. TOP DX lapp. 32x120x4,5x2 ⌀ 1	0004132	
GRADONE JOLLY lapp. 40x120x20 ⌀ 1	0004137	

9 mm

BATTISCOPA rett. 5,5x80 ⌀ 8	0003934	
GRADONE TOP rett. 32x120x4,5x2 ⌀ 1	0003944	
ANG. TOP SX rett. 32x120x4,5x2 ⌀ 1	0003949	
ANG. TOP DX rett. 32x120x4,5x2 ⌀ 1	0003954	
GRADONE JOLLY rett. 40x120x20 ⌀ 1	0003959	
BATTISCOPA lapp. 5,5x120 ⌀ 6	0003939	
GRADONE TOP lapp. 32x120x4,5x2 ⌀ 1	0004119	
ANG. TOP SX lapp. 32x120x4,5x2 ⌀ 1	0004124	
ANG. TOP DX lapp. 32x120x4,5x2 ⌀ 1	0004129	
GRADONE JOLLY lapp. 40x120x20 ⌀ 1	0004134	

9 mm









ASH

*160x320 rett.	0004962
120x120 rett.	0003771
120x120 lapp.	0004042
60x120 rett.	0003906
60x120 lapp.	0003926
30x120 rett.	0003911
80x80 rett.	0003921
60x60 rett.	0004109
30x60 rett.	0004112

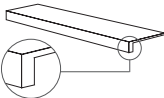
ABKSTONE

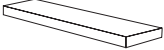
163,5x323 nat.	0004971
----------------	---------

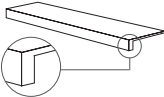
* Fino ad esaurimento scorte l'art. verrà consegnato a spessore 7 mm.
* The item will be delivered 7 mm thick until stocks are exhausted.

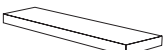
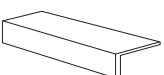
BATTISCOPA rett. 5,5x60 \varnothing 10	0004167	
BATTISCOPA rett. 5,5x80 \varnothing 8	0003935	
GRADONE TOP rett. 32x120x4,5x2 \varnothing 1	0003945	
ANG. TOP SX rett. 32x120x4,5x2 \varnothing 1	0003950	
ANG. TOP DX rett. 32x120x4,5x2 \varnothing 1	0003955	
GRADONE JOLLY rett. 40x120x20 \varnothing 1	0003960	
BATTISCOPA lapp. 5,5x120 \varnothing 6	0003940	
GRADONE TOP lapp. 32x120x4,5x2 \varnothing 1	0004120	
ANG. TOP SX lapp. 32x120x4,5x2 \varnothing 1	0004125	
ANG. TOP DX lapp. 32x120x4,5x2 \varnothing 1	0004130	
GRADONE JOLLY lapp. 40x120x20 \varnothing 1	0004135	

6 mm

9 mm

12 mm

9 mm



30x120





RED

*160x320 rett.	0003902
120x120 rett.	0003769
120x120 lapp.	0004040
60x120 rett.	0003904
60x120 lapp.	0003924
30x120 rett.	0003909
80x80 rett.	0003919
60x60 rett.	0004108
30x60 rett.	0004111

ABKSTONE

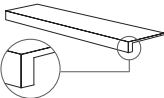
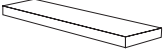
163,5x323 nat.	0003778
----------------	---------

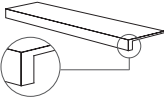
* Fino ad esaurimento scorte l'art. verrà consegnato a spessore 7 mm.
* The item will be delivered 7 mm thick until stocks are exhausted.

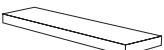
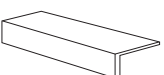
BATTISCOPA rett. 5,5x60 \varnothing 10	0004166	
BATTISCOPA rett. 5,5x80 \varnothing 8	0003933	
GRADONE TOP rett. 32x120x4,5x2 \varnothing 1	0003943	
ANG. TOP SX rett. 32x120x4,5x2 \varnothing 1	0003948	
ANG. TOP DX rett. 32x120x4,5x2 \varnothing 1	0003953	
GRADONE JOLLY rett. 40x120x20 \varnothing 1	0003958	
BATTISCOPA lapp. 5,5x120 \varnothing 6	0003938	
GRADONE TOP lapp. 32x120x4,5x2 \varnothing 1	0004118	
ANG. TOP SX lapp. 32x120x4,5x2 \varnothing 1	0004123	
ANG. TOP DX lapp. 32x120x4,5x2 \varnothing 1	0004128	
GRADONE JOLLY lapp. 40x120x20 \varnothing 1	0004133	

6 mm

9 mm

12 mm

9 mm



120x120







FOG

*160x320 rett.	0003903
120x120 rett.	0003772
120x120 lapp.	0004043
60x120 rett.	0003907
60x120 lapp.	0003927
30x120 rett.	0003912
80x80 rett.	0003922
60x60 rett.	0004110
30x60 rett.	0004113

ABKSTONE

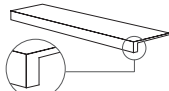
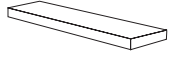
163,5x323 nat.	0005318
----------------	---------

* Fino ad esaurimento scorte l'art. verrà consegnato a spessore 7 mm.
* The item will be delivered 7 mm thick until stocks are exhausted.

BATTISCOPIA rett. 5,5x60 ⌀ 10	0004168		9 mm
BATTISCOPIA rett. 5,5x80 ⌀ 8	0003936		
GRADONE TOP rett. 32x120x4,5x2 ⌀ 1	0003946		
ANG. TOP SX rett. 32x120x4,5x2 ⌀ 1	0003951		
ANG. TOP DX rett. 32x120x4,5x2 ⌀ 1	0003956		
GRADONE JOLLY rett. 40x120x20 ⌀ 1	0003961		
BATTISCOPIA lapp. 5,5x120 ⌀ 6	0003941		
GRADONE TOP lapp. 32x120x4,5x2 ⌀ 1	0004121		
ANG. TOP SX lapp. 32x120x4,5x2 ⌀ 1	0004126		
ANG. TOP DX lapp. 32x120x4,5x2 ⌀ 1	0004131		
GRADONE JOLLY lapp. 40x120x20 ⌀ 1	0004136		

6 mm

9 mm

12 mm

9 mm

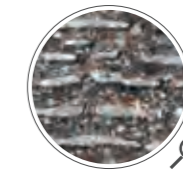

MARK FOG

60x120 rett.	0003929
30x120 rett.	0003931

9 mm



MARK EBONY

60x120 rett.	0003930
30x120 rett.	0003932

9 mm



0,5x120 ⌀ 4
MATITA ALLUMINIO
0000086



0,5x120 ⌀ 4
MATITA ALLUMINIO WHITE
0000087



0,5x120 ⌀ 4
MATITA ALLUMINIO BLACK
0000088



0,5x120 ⌀ 4
MATITA ALLUMINIO RAME
0000556



0,5x120 ⌀ 4
MATITA ALLUMINIO BRONZO
0000557

Articoli realizzati in alluminio per l'uso a parete, adatti a raccordare piastrelle di diverso spessore (9 mm / 7 mm).
Aluminium strip for use between wall tiles of different thicknesses (9 mm / 7 mm).

OUTDOOR R11 P3 9 mm

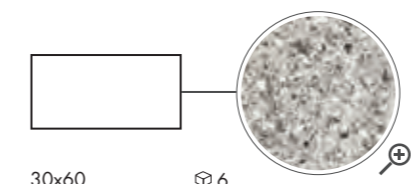

30x60
ASH GRIP rett. ⌀ 6
0004115

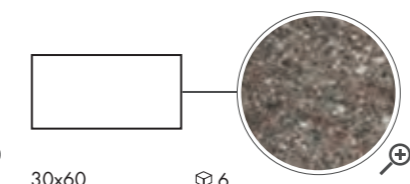

30x60
RED GRIP rett. ⌀ 6
0004114

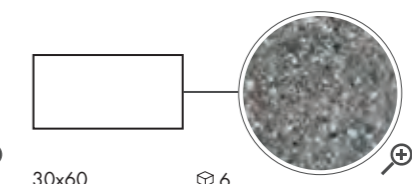

30x60
FOG GRIP rett. ⌀ 6
0004116

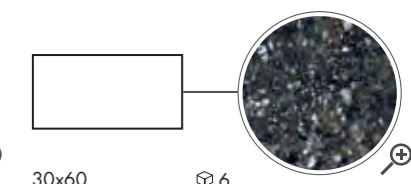

30x60
EBONY GRIP rett. ⌀ 6
0004969

60x60
ASH GRIP rett. ⌀ 3
0004414

60x60
RED GRIP rett. ⌀ 3
0004413

60x60
FOG GRIP rett. ⌀ 3
0004415

60x60
EBONY GRIP rett. ⌀ 3
0004970

OUT. 20 R11

▼
20 mm
▲



90x90
ASH 20 rekt
0004219



90x90
RED 20 rekt
0004218

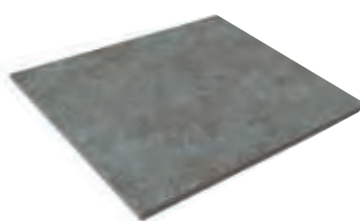

90x90
FOG 20 rekt
0004220

PEZZI SPECIALI / SPECIAL TRIMS

		ASH 20mm	RED 20mm	FOG 20mm
	ELEMENTO L 15x90x5 ☉ 2	0004222	0004221	0004223
	GRIGLIA 18x90 ☉ 4	0004225	0004224	0004226
	ANG. GRIGLIA SX 18x90 ☉ 4	0004228	0004227	0004229
	ANG. GRIGLIA DX 18x90 ☉ 4	0004231	0004230	0004232

46

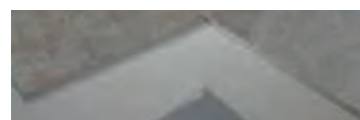

POSA TRADIZIONALE
la posa tradizionale è ideale per la realizzazione di pavimentazioni carrabili.

TRADITIONAL INSTALLATION
traditional installation is ideal for floorings that will be driven over by vehicles.



POSA A SECCO SU GHIAIA
La posa su ghiaia permette il perfetto drenaggio delle acque piovane.

DRY INSTALLATION ON GRAVEL
Installing on gravel enables perfect drainage of rainwater.



POSA A SECCO SU ERBA
La posa diretta su erba permette di creare percorsi e camminamenti integrandosi perfettamente nell'ambiente.

DRY INSTALLATION ON GRASS
Installing directly on top of grass enables the creation of paths and walkways that blend in perfectly with the surroundings.



POSA A SECCO SU SABBIA
La posa su sabbia permette di creare percorsi e camminamenti per spiagge e stabilimenti balneari.

DRY INSTALLATION ON SAND
Installing on top of sand is ideal for creating paths and walkways on beaches and beach bars.



POSA SOPRAELEVATA DA ESTERNO
Il sistema di pavimentazione sopraelevata prevede l'utilizzo di supporti portanti di tipo autolivellante, regolabili oppure fissi che si adattano con semplicità e sicurezza ad ogni tipo di pavimento sottostante. Il sistema permette la realizzazione di piani di posa con altezze variabili, da terra, comprese fra 25 e 270 mm. L'indipendenza della pavimentazione dai supporti garantisce l'assorbimento di eventuali movimenti strutturali. Il sistema sopraelevato non necessita di massetto in cemento e consente una diminuzione del peso sulla struttura portante. Le fughe aperte tra una piastrella ed un'altra consentono un facile deflusso dell'acqua piovana evitando tutti i rischi di accumulo o di ristagno. La presenza dell'intercapedine fra il piano di calpestio e il piano di appoggio favorisce l'aerazione e l'isolamento termico. Questa soluzione permette inoltre il passaggio di impianti e tubazioni nell'intercapedine, e la facile ispezione degli stessi una volta installata la pavimentazione.

OUTDOOR RAISED LAYING SYSTEM
The raised floor system foresees the use of self-levelling, adjustable or fixed load bearing supports that easily adapt to the floor below in total safety. The system is suitable to create laying designs with variable heights from the ground, which range between 25 and 270 mm. The independence of the flooring from the supports guarantees the absorption of any structural movements. The raised system does not require a cement screed and reduces the load on the bearing structure. The open joints between the tiles allow rainwater to easily drain off, avoiding any risk of water accumulation or stagnation. The gap between the tread surface and the support surface favours ventilation and heat insulation. This solution allows for the installation of systems and piping in the gap, which can be easily inspected even once the floor has been installed.

GRADONE JOLLY

Il gradone Jolly **JO** di **OLMOLab** è un pre-assemblato costituito da due lastre in gres porcellanato: la pedata, di dimensione 120x40 cm e l'alzata di dimensione 120x20 cm, tenute insieme perpendicolarmente lungo lo spigolo da una resina ad alta resistenza.

Le dimensioni di questo elemento pre-assemblato sono state studiate per permettere ai posatori, una volta calcolate le reali dimensioni della scala, di ricavarne tutte le parti che compongono il gradino definitivo (un fascione, da cui si possono estrapolare gli elementi laterali e il battiscopa e l'elemento gradino già assemblato).

JO, è caratterizzato da una lavorazione "JOLLY" in tutti i lati, in modo da facilitare il lavoro dei posatori nella fase di assemblaggio (vedi puntini neri nel disegno in basso).

The Jolly **JO** step from **OLMOLab** is a pre-assembled unit consisting of two porcelain slabs (a 120x40 cm tread and a 120x20 cm riser) held together at right-angles by a high-strength resin.

The dimensions of this pre-assembled unit are specially chosen to enable tile layers to cut out all the components of the finished step (a strip, from which the side pieces and skirting can be cut, and the pre-assembled step itself) according to the real dimensions of the stairs.

JO comes with mitred edges on all sides to facilitate the tile layer's work during assembly (see black dots in drawing below).

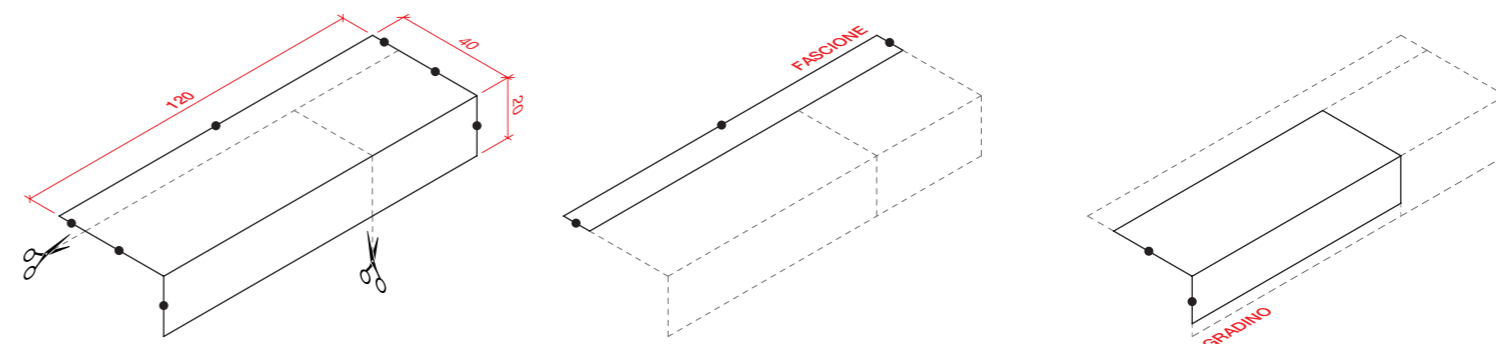

FASCIONE
Dall'elemento "fascione" si possono ricavare i laterali L1 e L2 e il battiscopa B1 e B2.

STRIP
The strip can be cut into the side pieces L1 and L2 and the skirting elements B1 and B2.



GRADINO
L'elemento "gradino", una volta rifilata la lastra verticale, riportandola alla giusta dimensione dell'alzata, è pronto per essere posato, presentando i 2 lati "jollati" da assemblare con i "laterali" L1 ed L2. Anche gli elementi B1 e B2 sono pronti per essere posizionati.

STEP
After trimming the vertical section to the correct size for the riser, the step element is ready for installation. It comes with 2 mitred edges to ensure a perfect joint with the side pieces L1 and L2. The skirting elements B1 and B2 are also ready to be installed.

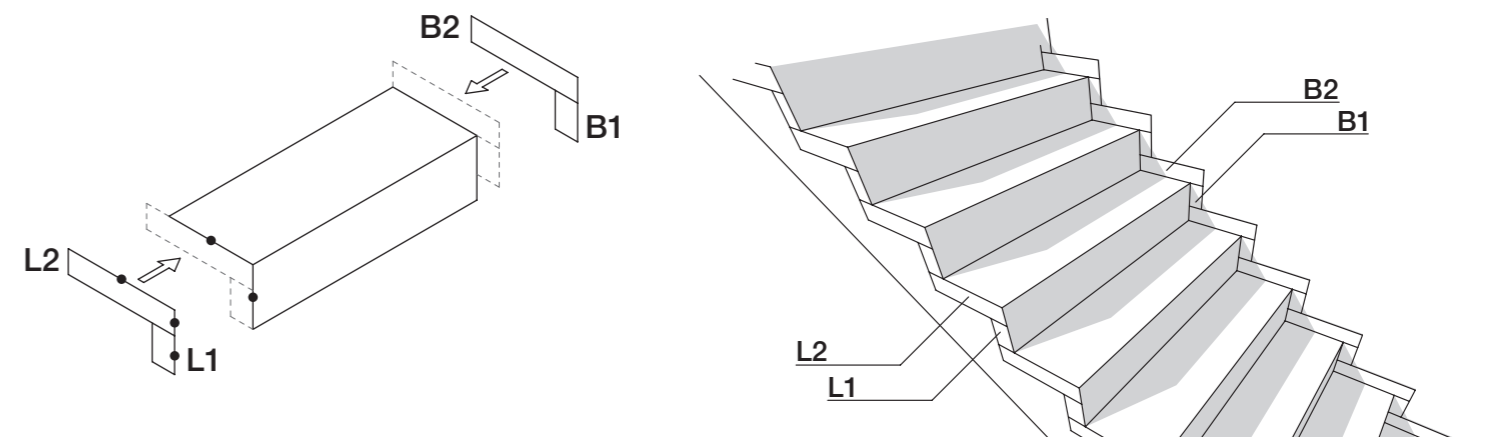

47

WIDE

SUPERSIZE SLABS

CERAMIC R-EVOLUTION

Il progetto WIDE ABK parte dalla rivoluzionaria tecnologia produttiva CONTINUA+, che permette di produrre lastre in gres porcellanato robuste e leggere allo stesso tempo, grazie allo spessore ridotto di 6 mm, fino alla dimensione record di 160x320 cm. Il nuovo sistema di pressatura prevede la compattazione a secco delle materie prime e consente di ottenere superfici particolarmente apprezzabili sia per la qualità estetica che per le performance tecniche.

ABK's WIDE collection consists of tough yet lightweight porcelain slabs with a thickness of just 6 mm and a record size of 160x320 cm produced using the revolutionary CONTINUA+ technology. The new pressing system involves dry compaction of raw materials and is able to produce surfaces that combine excellent aesthetic quality with outstanding technical performance.



WIDE & STRONG

WIDE è perfettamente idoneo sia per il rivestimento che per la pavimentazione, in ambito residenziale e commerciale. Lo spessore 6 mm consente di mantenere un'ottima resistenza al carico di rottura reale.

WIDE is ideal as both a floor and wall covering in residential and commercial projects. The 6 mm thickness enables it to maintain excellent breaking strength in real situations.



LITE GOES WIDE

Lo spessore di 6 mm consente di ridurre il peso per mq con interessanti vantaggi in termini di maneggevolezza e movimentazione.

The 6 mm thickness results in a reduced weight per square metre, bringing significant advantages in terms of ease of working and handling.



WIDE IS LEVELING

La combinazione fra impasto ad elevata plasticità, spessore e grande dimensione, dona particolare elasticità al prodotto, per ottenere risultati di posa sempre impeccabili.

The combination of a body with high plasticity, thickness and dimensions makes for a highly elastic product that delivers consistently flawless results.



EASY AS WIDE

La formulazione dell'impasto, unita alla compattazione a secco e alla cottura in forni di nuova concezione, genera un gres particolarmente facile da tagliare e lavorare.

The chemical formulation of the body combined with the raw material dry compaction process produces a porcelain slab that is easy to cut and work with.



WIDE MEANS GREEN

L'impasto contiene il 40% minimo di materie prime di qualità recuperate da altri processi produttivi, per questo i prodotti WIDE possono essere accreditati all'interno del sistema internazionale LEED.

As the body contains a minimum of 40% high-quality raw materials recycled from other production processes, WIDE collection products qualify for LEED international certification.

PESO WEIGHT

ABK 9 mm = 19,5 Kg x mq
ABK 6 mm = 15,0 Kg x mq

indicatore di flessibilità flexibility index	deflessione massima sotto carico di 350 N maximum deflection under load of 350 N	lato/length 2400 mm lato/length 3200 mm	> 50 mm > 100 mm
---	---	--	---------------------

NEW DIMENSIONS

Uno degli obiettivi del progetto WIDE è quello di fornire un materiale ceramico tecnologicamente avanzato facilmente utilizzabile in contesti anche molto diversi, per dimensione e per destinazione d'uso. WIDE è un vero e proprio programma di formati, tutti rettificati, pensati per coprire a 360° le esigenze legate alla progettazione, a partire dagli spazi residenziali, fino alle grandi opere in ambito pubblico e commerciale.

One of the aims of the WIDE project is to supply a hi-tech ceramic material that is easy to use in very different sizes and applications. WIDE comes in a large selection of sizes, all rectified, ideal for uses ranging from residential through to large-scale works in public and commercial spaces.

EVERYWHERE YOU LIKE

Tenendo conto delle principali qualità del materiale, tra cui la robustezza, la resistenza agli sbalzi termici, oltre allo spessore contenuto e alla facilità di lavorazione, le grandi lastre WIDE ampliano la destinazione d'uso del gres porcellanato. Sempre meno fughe e sempre più spazio alla creatività di progettisti e interior designers, che grazie ai prodotti WIDE possono apprezzare la versatilità di una ceramica senza più confini.

Taking account of the material's key qualities, including strength, thermal shock resistance, low thickness and ease of working, the WIDE large-format slabs extend the fields of use of porcelain. The WIDE collection has fewer joints while giving enormous creative freedom to architects and interior designers, who appreciate the versatility of this ceramic surface without limits.



PAVIMENTI INTERNI
INDOOR FLOORS



RIVESTIMENTI INTERNI
INDOOR WALLS

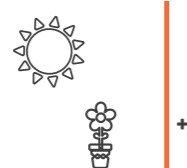

FACCIAE ESTERNE
INCOLLATE E VENTILATE
GLUED AND VENTILATED
EXTERIOR FAÇADES

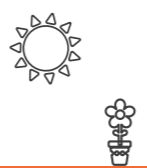

PAVIMENTI AREE ESTERNE
OUTDOOR FLOORS



PIANI LAVORO CUCINE
KITCHEN COUNTERTOPS



TOP E FINITURE PER
AMBIENTI BAGNO
BATHROOM VANITY TOPS
AND SHELVES



ELEMENTI DI ARREDO E
DESIGN PER INTERNI
INTERIOR FURNISHING
AND DESIGN ELEMENTS

IMBALLI/PACKAGING

F.to nominale (cm) Nominal size (cm)	F.to reale (mm) Work size (mm)	Spessore Thickness	Tipologia imballo Type of packing	Lastre/Imballo Slabs/Packing	Pz/Scatola Pcs/Box	Mq/Scatola Sqm/Box	Kg/Scatola Kg/Box	Scatole/ Imballo Box/Packing	Mq totali Sqm total	Kg/Imballo Kg/Packing	Kg totali Kg total
163,5x323 nat. 65.2"x129.2" nat.	1635x3230	12 mm	Cassa Crate	10	-	-	-	-	51,20	139	1.660
163,5x323 nat. 65.2"x129.2" nat.	1635x3230	12 mm	Cavaletto container legno A-frame Container Rack pallet wood A-frame	22	-	-	-	-	112,64	180	3.524
163,5x323 nat. 65.2"x129.2" nat.	1635x3230	12 mm	Cavaletto container metallo A-frame Container Rack pallet metal A-frame	22	-	-	-	-	112,64	180	3.524
160x320 rett. 64"x128" rett.	1596,5x3195	6 mm	Cassa Crate	14	-	-	-	-	71,68	139	1.214
			Cavaletto container Container Rack pallet	36	-	-	-	-	184,32	180	2.945
120x120 rett. 48"x48" rett.	1194x1194	9 mm	Pallet con sponde Pallet with sides	36	2	2,88	56,16	18	51,84	40	1.051
80x80 rett. 32"x32" rett.	797,25x797,25	9 mm	Pallet	88	2	1,28	25,00	44	56,32	20	1.120
60x120 rett. 24"x48" rett.	596x1194	9 mm	Pallet	60	2	1,44	28,00	30	43,20	20	860
30x120 rett. 12"x48" rett.	297x1194	9 mm	Pallet	144	4	1,44	28,00	36	51,84	20	1.028
60x60 rett. 24"x24" rett.	596x596	9 mm	Pallet	120	3	1,08	21,20	40	43,20	20	868
30x60 rett. 12"x24" rett.	297x596	9 mm	Pallet	240	6	1,08	21,20	40	43,20	20	868
90x90 rett. 36"x36" rett.	896x896	20 mm	Pallet	30	1	0,81	36,60	30	24,30	20	1.118

L'unità minima di vendita per tutti gli articoli (fondi, decori e pezzi speciali) è la scatola completa. / The minimum sales quantity for all items (plain tiles, decorations and special trims) is one full box. I dati relativi agli imballi sono aggiornati al momento della stampa del catalogo e pertanto possono subire variazioni nel corso del tempo. / Data referring to packaging have been updated at time of printing; the actual data may be slightly different. Pezzi speciali e decori per effetto delle lavorazioni, possono presentare variazioni di tonalità. / Due to working process special trims and decors, may show variation in tonality.

CARATTERISTICHE TECNICHE / TECHNICAL FEATURES

CLASSIFICAZIONE SECONDO NORME UNI EN 14411 (ISO 13006) ALLEGATO G-Gruppo B1a
CLASSIFICATION IN ACCORDANCE WITH UNI EN 14411 (ISO 13006) ANNEX G-Group B1a

LASTRE IN GRES PORCELLANATO A MASSA COLORATA FULL BODY COLORED PORCELAIN SLABS	NORMA NORM	VALORE PRESCRITTO DALLE NORME VALUE PRESCRIBED FROM THE NORMS	VALORE ABK ABK VALUE NATIVE	VALORE ABK ABK VALUE NATIVE OUTDOOR
RESISTENZA AL GELO FROST RESISTANCE	UNI EN ISO 10545/12	RICHIESTA REQUIRED	INGELIVO FROST PROOF	INGELIVO FROST PROOF
	B.C.R.A. C.A.	$\mu < 0,19$ SCIVOLOSITÀ PERICOLOSA - DANGEROUSLY SLIPPERY $0,20 < \mu < 0,39$ SCIVOLOSITÀ ECCESSIVA - EXCESSIVELY SLIPPERY $0,40 < \mu < 0,74$ ATTRITO SODDISFACENTE - SATISFACTORY GRIP $\mu > 0,75$ ATTRITO ECCELLENTE - EXCELLENT GRIP	> 0,40	> 0,40
	B.C.R.A. G.B.		> 0,40	> 0,40
	ASTM C 1028 (S.C.O.F.)	SLIP RESISTANT (> 0,60)	> 0,60 DRY > 0,60 WET	> 0,60 DRY > 0,60 WET
RESISTENZA ALLO SCIVOLAMENTO SLIP RESISTANCE	DIN 51130	IN FUNZIONE DELL'AMBIENTE O DELLA ZONA DI LAVORO BASING ON THE ENVIRONMENT OR THE WORKING AREA	R10	R11
	DIN 51097	-	A+B	A+B+C
	ANSI A 137-1:2012	$\geq 0,42$	> 0,42	> 0,42

VARIAZIONE CROMATICA SHADE VARIATION	V2	aspetto uniforme uniform appearance V1	lieve variazione slight variation V2	moderata variazione moderate variation V3	forte variazione substantial variation V4
---	----	--	--	---	---



La riproduzione dei colori è approssimativa.
Colour reproduction approximate.



Marketing ABK Group
Direfarecreate.it
19.7

ABK Group Industrie Ceramiche s.p.a. - via S.Lorenzo N.24/a - 41034 Finale Emilia - Modena Italy
tel. 0535 761311 - fax 0535 761320/92800/761351

www.abk.it
#abkemozioni

ABK
EMOZIONI IN SUPERFICIE