

GIGACER<sup>®</sup>





**book.**

**2023**

**Index /**  
Indice

02 / ABOUT US  
14 / COLLECTIONS  
136 / LE CORBUSIER CERAMICS  
178 / GIGACER MATCHINGS  
202 / TECHNICAL NOTES

# GIGACER /

About us



**Index /**  
Indice

**04 / COMPANY | AZIENDA**  
**06 / QUALITY | QUALITÀ**  
**08 / CRAFTMANSHIP | ARTIGIANALITÀ**  
**10 / SUSTAINABILITY | SOSTENIBILITÀ**  
**12 / TAILOR MADE | SU MISURA**

# COMPANY

{a·zièn·da}



Excellence in ceramic materials and know-how: for Gigacer ceramics are an architectural medium. The Gigacer collection's porcelain stoneware slabs are designed to be a full-blown design tool using colours and surface textures to line volumes and spaces.

Over the years the distinctive traits of its philosophy have become Gigacer's strengths:

- research into surface textures and material consistencies;
- choice of the colours best suited to a project and which lend themselves to architectural composition;
- overall aesthetic effect triggered by a combination of material and colour designed to act as a building's residential backdrop against which its interior design is to be created.

Visual and tactile effects transmitting homogeneous vibrations. For us surfaces are well-designed compositional elements first and foremost when aesthetics and material textures are coherent.

Proudly made in Italy, Gigacer's products are designed to last, just like architecture.

Eccellenza nei materiali e nel saper fare ceramico, Gigacer propone la ceramica come strumento per l'architettura. Le lastre in gres porcellanato delle collezioni Gigacer sono pensate per essere un vero e proprio utensile nelle mani del progettista: i colori e le superfici materiche con cui rivestire i volumi e gli spazi.

I tratti distintivi della filosofia aziendale sono diventati nel tempo i punti di forza di Gigacer:

- lo studio della superficie, della sua texture e della sua consistenza materica;
- la scelta del colore che si adegua al progetto, prestandosi alla composizione architettonica;
- l'effetto estetico complessivo, che scaturisce dalla combinazione di materia e colore, pensati per essere la scena dell'abitare, il fondale su cui comporre l'interior design.

L'effetto visivo e l'effetto tattile trasmettono vibrazioni omogenee. Secondo noi, la superficie è un elemento compositivo ben progettato innanzitutto quando c'è coerenza fra estetica e matericità.

Orgogliosamente made in Italy, i prodotti Gigacer sono pensati per durare nel tempo, proprio come l'architettura.



# QUALITY

{qua·li·tà}

In ceramics quality is expressed over time: a look which stands the test of time is the strength of design, technical resistance to wear and tear is the strength of porcelain stoneware.

Porcelain stoneware is a hard-wearing and compact ceramic product obtained by firing specific clays previously ground up into ultra-fine particles at extremely high temperatures. Gigacer produces and certifies its porcelain stoneware slabs with technical characteristics up to the highest sector standards.

Technical durability combined with the beauty of porcelain stoneware has made it the most frequent choice for floors and walls, both inside and out and in all contexts.

Porcelain stoneware is: frost resistant, fire resistant, stain resistant, anti-bacterial, hygienic, mould resistant, chemical resistant, zero-maintenance, recyclable and environmentally friendly, non-slip, easy to clean, usable in dry, wet and even underwater contexts, scratch-proof, wear and tear resistant, extremely high impact breakage resistance, ultra-long life cycle.

La qualità in ceramica si esprime nel tempo: la resistenza estetica è la forza del design, la resistenza tecnica è la forza caratteristica del gres porcellanato.

Il gres porcellanato è un prodotto ceramico resistente e compatto, ottenuto dalla cottura ad altissime temperature di particolari argille precedentemente macinate in finissime particelle. Gigacer produce e certifica le sue lastre in gres porcellanato con caratteristiche tecniche ai migliori livelli del settore.

La resistenza tecnica unita alla bellezza estetica del gres ne hanno fatto il materiale più utilizzato per pavimenti e rivestimenti in interno e in esterno, in ogni contesto applicativo.

Il gres porcellanato è: ingelivo, resistente al fuoco, resistente alle macchie, antibatterico, igienico, resistente alla muffa, agli attacchi chimici, non richiede manutenzione, riciclabile ed ecologico, antiscivolo, facile da pulire, utilizzabile in contesti asciutti, bagnati e anche sommersi, resistente al graffio, resistente all'usura, resiste ad altissimi carichi di rottura, ciclo di vita lunghissimo.



# CRAFTMANSHIP

{ar·ti·gia·na·li·tà}



In Faenza ceramics are an art and a centuries-old tradition. Local technical know-how means we can count on sector professional excellence as well as creative flair unique to the area.

Gigacer was founded right here in Faenza, the cradle of ceramics and the jewel in the industrial and artisanal ceramic material production technology crown. The area offers the environment and skills necessary for the development of innovative, avant-garde sector design in accordance with all the most rigorous environmental and product quality standards. Expertise and technological innovation meld in a new approach to ceramics: flexibility, originality, top quality, a focus on fulfilling the demands of an increasingly exacting market and, first and foremost, a propensity for new product research.

La ceramica a Faenza è un'arte, oltre che una tradizione centenaria. La competenza tecnica sviluppata nel territorio ci permette di contare sulle eccellenze professionali del settore, oltre che su un'inventiva e una capacità creativa uniche al mondo.

Gigacer nasce proprio a Faenza, culla della ceramica e punta di diamante della tecnologia produttiva industriale e artigianale di materiali ceramici. Il territorio offre l'ambiente e le competenze necessarie per lo sviluppo di un progetto innovativo all'avanguardia nel suo settore e in linea con tutte le più rigorose normative sull'ambiente e la qualità dei prodotti. L'esperienza e l'innovazione tecnologica si fondono nel progetto di un nuovo modo di fare ceramica: flessibile, originale, di alta qualità, orientato alla soddisfazione delle richieste di un mercato sempre più esigente e, soprattutto, alla ricerca di nuovi prodotti.





# SUSTAINABILITY

{so·ste·ni·bi·li·tà}



We work to improve your life respecting the environment. We pay close attention to:

- . the safety and comfort of our production staff;
- . the respect for the environment in and around the factory;
- . the safety of tile layers in the building site, which is guaranteed by the specially designed packaging that makes movement easier and that is completely recyclable.

We manufacture large porcelain slabs thanks to the application of advanced technologies, in accordance with the current European environmental standards and often with even better results.

For this reason, the engines manufacturing systems are installed in soundproof areas, the lighting around the production area is of low emission, there is an environmental monitoring in real time of the production areas, and the complete packaging – sidepack – uses minimum quantities of cardboard and, however, the material used for packaging which is both is completely recyclable and glueless.

The 4.8 thin slab is in fact the most advanced system concerning energy saving: it gives us the possibility of manufacturing high quality porcelain stoneware tiles with a remarkable energy saving, both in firing and in transport.

Lavoriamo per rendere più bella la vostra vita nel rispetto dell'ambiente. Curiamo con particolare attenzione:

- . la sicurezza ed il comfort del personale addetto alla produzione;
- . il rispetto dell'ambiente in cui sorge lo stabilimento;
- . la sicurezza del personale sul cantiere, garantita da imballaggi studiati per facilitare la movimentazione e completamente riciclabili.

Produciamo lastre ceramiche grazie all'applicazione di tecnologie all'avanguardia, nel rispetto delle vigenti normative europee sull'ambiente e spesso con parametri molto migliori di queste ultime.

Per questo i macchinari si trovano in ambienti insonorizzati, l'illuminazione della linea produttiva è a basso regime, esiste un monitoraggio ambientale in tempo reale, il sistema di imballaggio – sidepack – prevede l'utilizzo di quantità di cartone minime e comunque i materiali dell'imballo sono completamente riciclabili e privi di colle.

La lastra sottile costituisce l'orizzonte del risparmio energetico in ceramica: offre la possibilità di produrre gres porcelanato di altissima qualità con notevole risparmio di energia sia in fase di cottura, sia per il trasporto.



# TAILOR MADE

{su·mi·su·ra}



Gigacer offers a tailor-made machining service on all products: thanks to Gigacer Service is possible to cut, perforate, polish and generally adapt slabs to the individual project in line with the requirements of a specific client design.

Gigacer offre un servizio di lavorazioni su misura su tutti i suoi prodotti: con Gigacer Service è possibile tagliare, forare, lucidare e in generale adattare le lastre al singolo progetto, seguendo le indicazioni di uno specifico disegno del cliente.





# GIGACER / Collections



- 16 / ARGILLA
- 24 / CONCEPT 1
- 32 / CONCRETE
- 40 / CONCRETE SIGNS
- 48 / ELEMENTA
- 56 / GATSBY
- 64 / INCLUSIONI CLASSICO
- 72 / INCLUSIONI SOAVE
- 80 / KREA
- 88 / LIGHT
- 96 / LIGHT 250
- 104 / MADE 2.0
- 112 / QUARRY
- 120 / TELE
- 128 / TERRA

# Argilla

## Terre e Acque

Argilla rediscovers the most natural expressions of the Faentinian lands, the clays, creating a chromatic range with a pastel shade, where the material becomes the main subject. The Dry grey and the Biacca Clear, modern and refined colors, recall the presence of a vein of chalk, determining a cold and rocky trend. Fog brown and Dark brown are presented in warmer tones recalling the more superficial clays. Vetiver and Marine complete the collection with reference to water, the natural compendium of the earth. The two surfaces of the collection, which interpret the same color, underline the plasticity of our raw material: the Quartz surface, material and pasty Material, is almost waxy and very soft.

## Terre e Acque

Argilla riscopre le espressioni più naturali delle terre faentine, le argille, creando una gamma cromatica dalla tonalità pastello, in cui la materia diventa protagonista. Il grigio Dry e il chiaro Biacca, colori moderni e raffinati, ricordano la presenza di una vena del gesso, determinando una tendenza fredda e rocciosa. Il marrone Fog e il bruno Dark, si presentano con tonalità più calde richiamando le argille più superficiali. Vetiver e Marine completano la collezione con il riferimento all'acqua, naturale compendio della terra. Le due superfici della collezione, che interpretano il medesimo colore, sottolineano la plasticità della nostra materia prima: quasi cerosa e morbidissima la superficie Quartz, materica e pastosa Material.

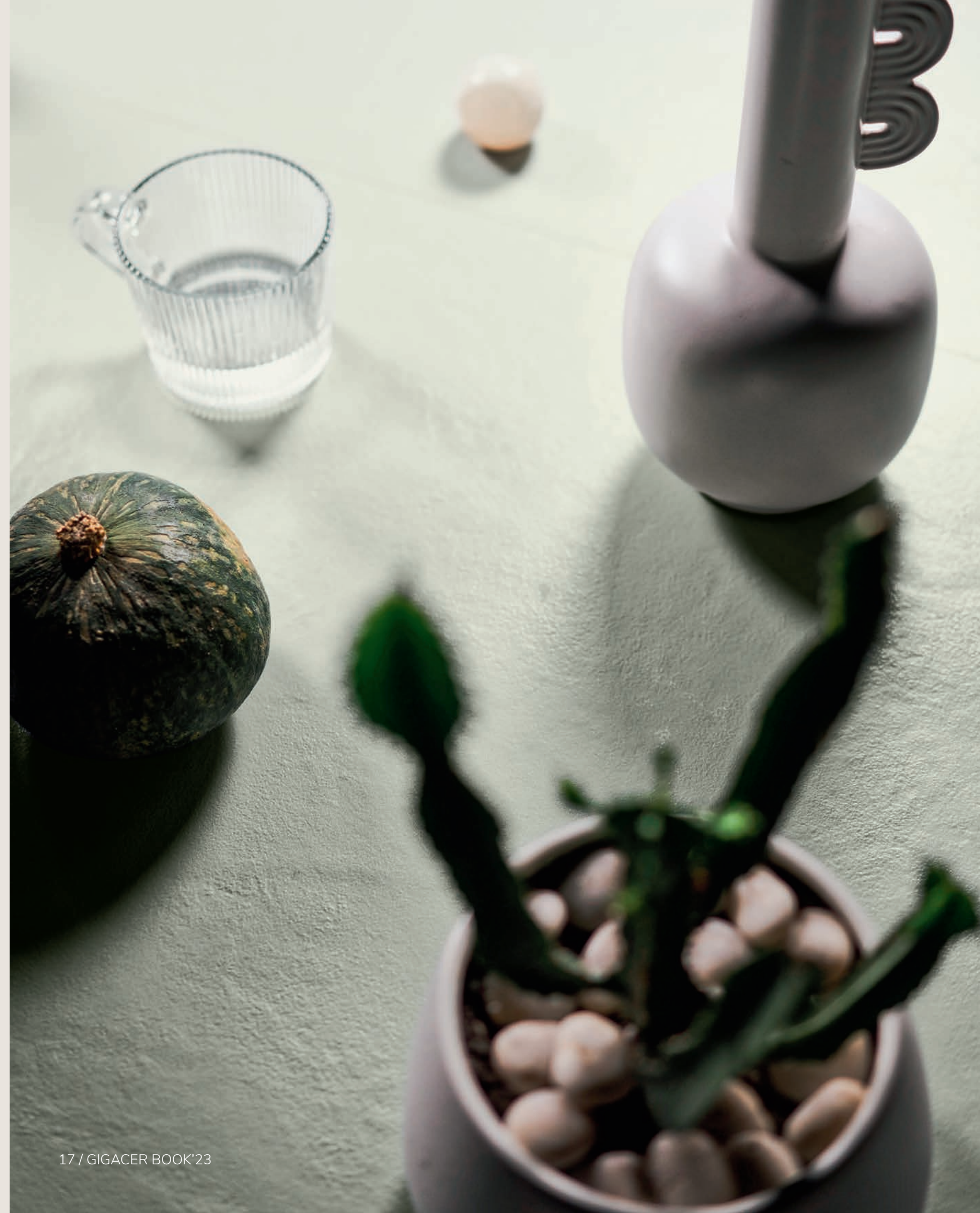



WALL | PARETE  
Argilla Dark Material  
Mosaic 1.5x1.5 30x30 cm · 12"x12" #6 mm

FLOOR | PAVIMENTO  
Argilla Fog Material  
120x120 cm · 48"x48" #6 mm

COUNTER | BANCONE  
Concrete Graphite Mat  
Gigacer Service #12 mm

COFFEE TABLE COUNTER TOP | PIANO DEI TAVOLINI  
Argilla Material - All colours  
Gigacer Service #6 mm





**WALL | PARETE**  
 Argilla Vetiver Material  
 60x120 cm · 24"x48" #6 mm

Argilla Vetiver Material  
 Stripes Mosaic 1.5x120 15x120 cm · 6"x48" #6 mm

**FLOOR | PAVIMENTO**  
 Argilla Vetiver Material  
 60x120 cm · 24"x48" #6 mm

Argilla Vetiver Material  
 Stripes Mosaic 1.5x120 15x120 cm · 6"x48" #6 mm

**WALL | PARETE**  
 Argilla Marine - Biacca Material  
 Small Pentagon 17x10 cm · 7"x4" #6 mm

**FLOOR | PAVIMENTO**  
 Argilla Marine Quartz  
 60x60 cm · 24"x24" #12 mm

**TOP | PIANO**  
 Concrete White Mat through body | tutta massa  
 Gigacer Service #12 mm

**CABINETS DOORS | ANTE**  
 Concrete Black Mat  
 Gigacer Service #6 mm





# Argilla

## COLOURS

COLORI



Biacca Dry Vetiver Marine Fog Dark

## SURFACES

SUPERFICI



## SIZES AND THICKNESSES

FORMATI E SPESSORI

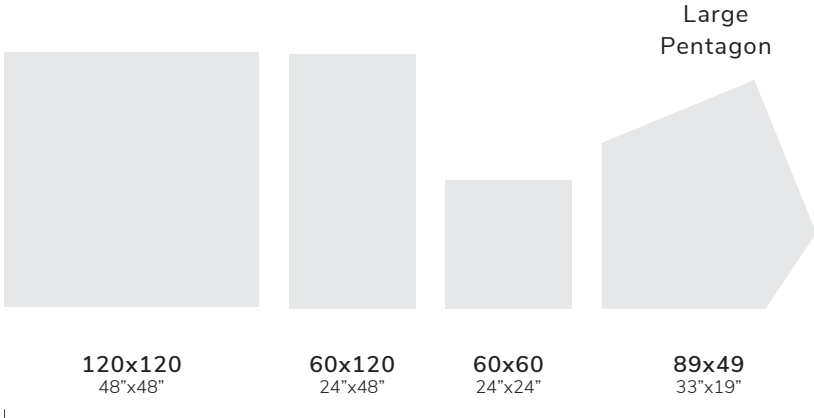
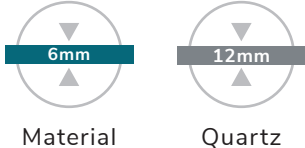

120x120 48"x48" 60x120 24"x48" 60x60 24"x24" 89x49 33"x19"

#6 mm | #12 mm

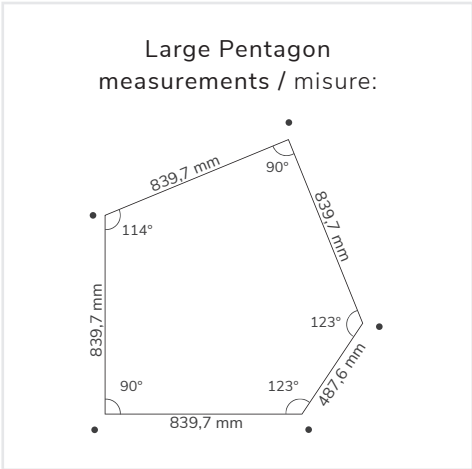

Large Pentagon measurements / misure:

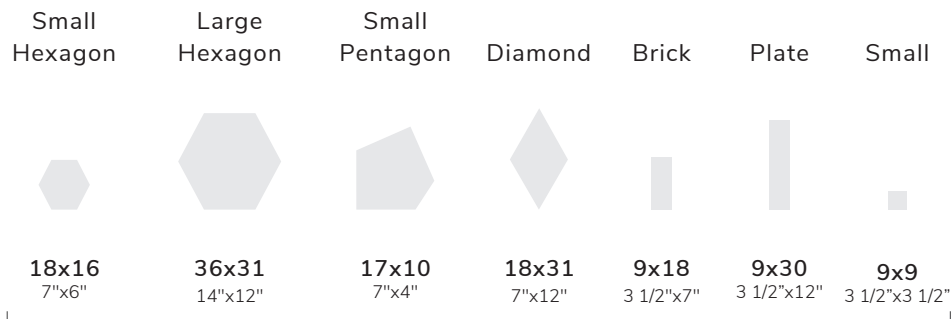

18x16 7"x6" 36x31 14"x12" 17x10 7"x4" 18x31 7"x12" 9x18 3 1/2"x7" 9x30 3 1/2"x12" 9x9 3 1/2"x3 1/2"

#6 mm PlayOne Shapes

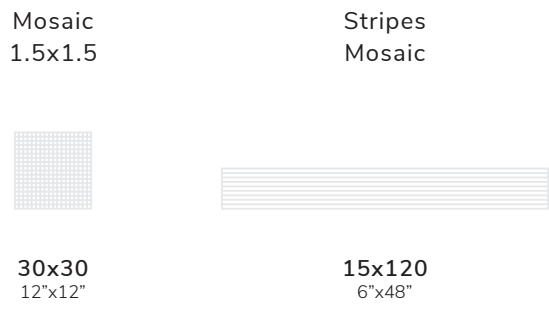

30x30 12"x12" 15x120 6"x48"

#6 mm PlayOne Mosaics



# Concept 1

## All in One

Concept 1 is to conceive space with unity of form and style, using technical solutions that maintain aesthetic continuity through the environments and their multiplicity of uses, indoors, outdoors, on walls and furniture, in short: all in one. A unique ceramic range designed for every type of application, with a variety of colours and surfaces that can always be combined in an exclusive and personal way. A resistant, eclectic porcelain stoneware in natural and homogeneous shades, with 5 colours, 5 different surfaces and 3 thicknesses.

## All in One

Concept 1 è concepire lo spazio con unità di forma e stile, con soluzioni tecniche che conservano continuità estetica attraverso gli ambienti e la loro molteplicità di utilizzi, in interno, in esterno, a parete e nell'arredo, in breve: tutto in uno. Un'unica gamma in ceramica pensata per ogni tipo di applicazione, con una varietà di colori e superfici combinabili sempre in modo esclusivo e personale. Un gres porcellanato resistente, eclettico, dai toni naturali ed omogenei, con 5 colori di fondo, 5 diverse superfici e 3 spessori.





WALL | PARETE  
Concept 1 Ink Platinum Texture Mat  
Gigacer Service #6 mm

FLOOR | PAVIMENTO  
Concept 1 Ink Levigato  
120x120 cm · 48"x48" #6 mm

WARDROBE INTERIOR | INTERNO ARMADIO  
Concept 1 Ink Texture Levigato  
120x250 cm · 48"x100" #6 mm

OUTDOOR FLOOR | PAVIMENTO ESTERNO  
Concept 1 Ink Bocciardato R11  
120x120 cm · 48"x48" #12 mm





WALL | PARETE  
Concept 1 Ash Texture Levigato  
120x250 cm · 48"x100" #6 mm

FLOOR | PAVIMENTO  
Concept 1 Milk Texture Mat  
120x120 cm · 48"x48" #6 mm

KITCHEN CABINETS | ANTE CUCINA  
Concept 1 Land Mat  
Gigacer Service #6 mm

TABLE | TAVOLO  
Concept 1 Land Texture Levigato  
Gigacer Service #6 mm





# Concept 1

## COLOURS

COLORI

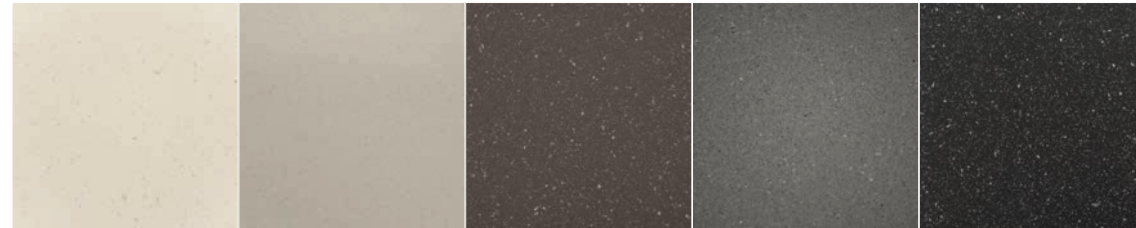

Milk Stone Land Ash Ink

These pictures portray a portion of the slabs only.  
Le immagini rappresentate riproducono una porzione delle lastre.

## SIZES AND THICKNESSES

FORMATI E SPESSORI

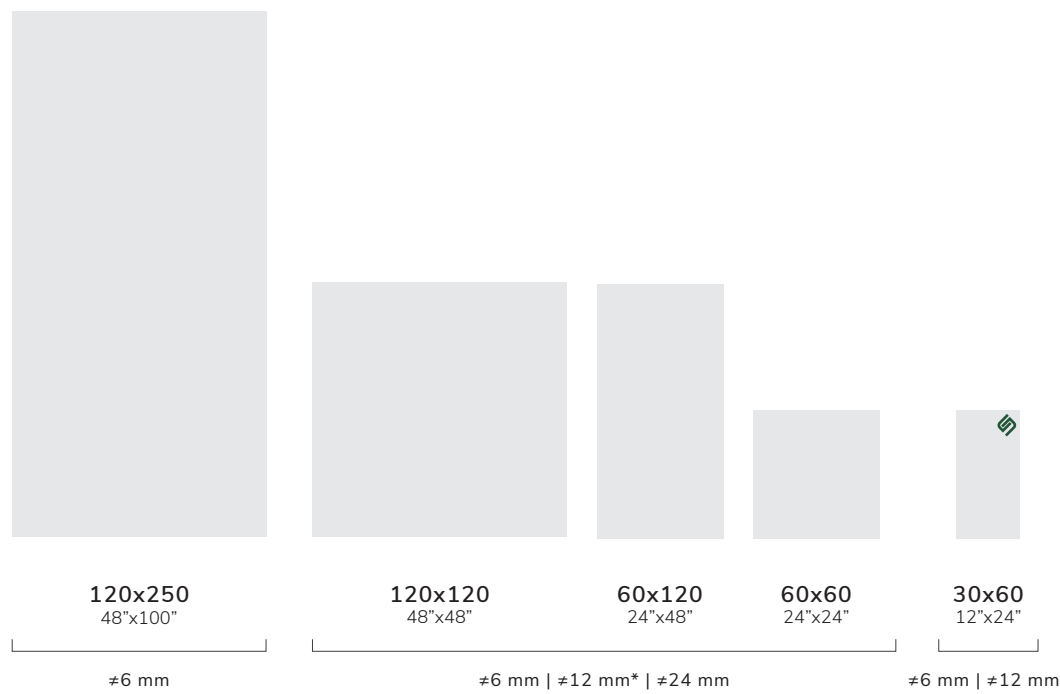

Notes / Note:  
\* Available Bocciardato R10 and R11 surface, specify in the order / Disponibile nella superficie Bocciardato R10 e R11, specificare nell'ordine.

## SURFACES

SUPERFICI

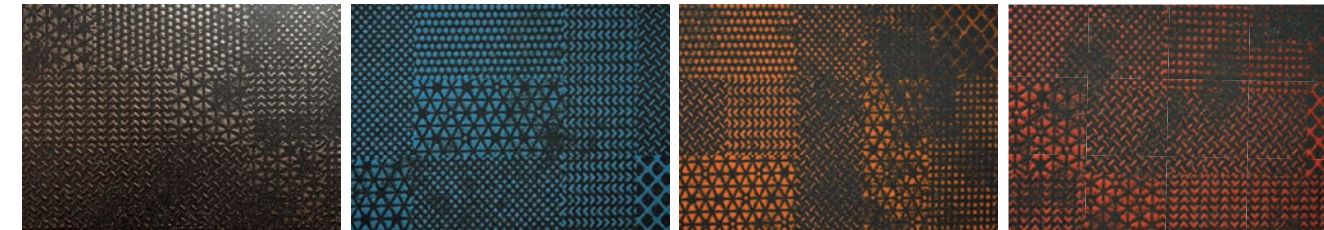
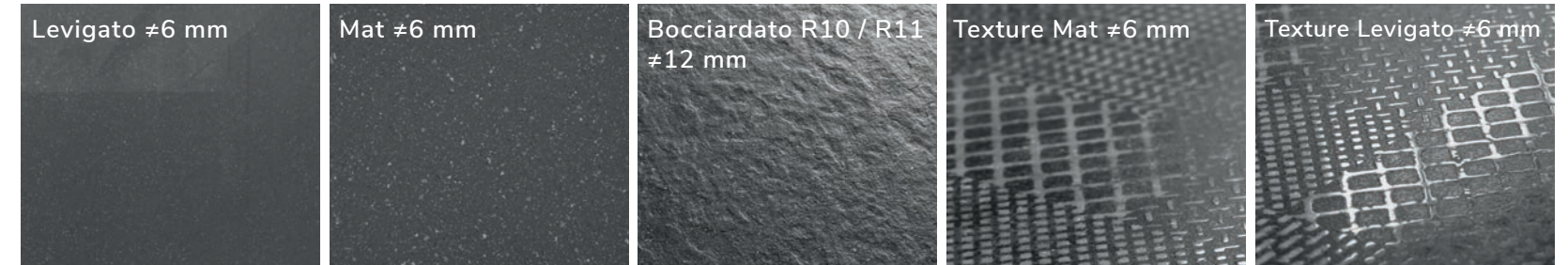

Ink Platinum Ink Turquoise Ink Flame Ink Red

Notes / Note:  
Platinum, Red, Turquoise and Flame Texture Mat are available on Ink colour basis only / Platinum, Red, Turquoise e Flame Texture Mat sono disponibili solo su base colore Ink.  
All images reproduce a portion of the slab / Tutte le immagini riproducono una porzione delle lastre.

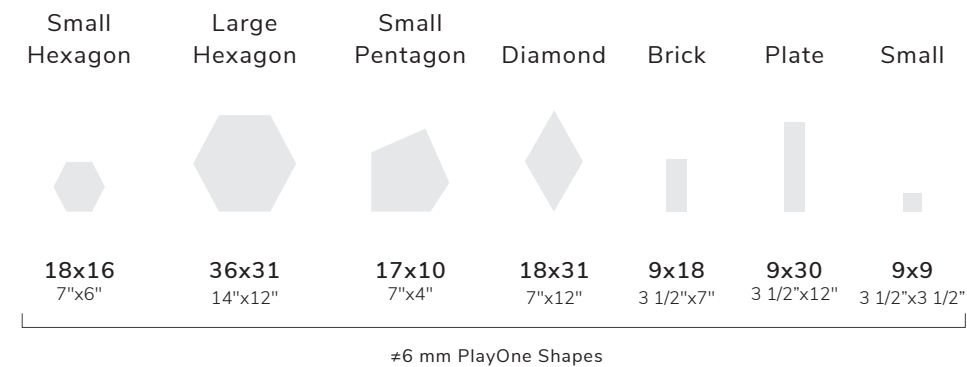

#6 mm PlayOne Shapes



# Concrete

## Design Surround

Concrete, in synergy with Made 2.0, is a flexible ceramic system at the service of living spaces. It is the most complete color / surface combination palette in neutral and natural shades: thirteen colors and four different surfaces that adapt to the different needs of living. The same color can be used from inside to outside, in floors and walls and for the creation of kitchen tops and bathroom furniture while maintaining a strong color consistency. The whole Concrete color palette corresponds to the colors Made 2.0; the White color matches the Made 2.0 White Sand.

## Design Surround

Concrete, in sinergia con Made 2.0, è un flessibile sistema ceramico al servizio degli spazi abitativi. È la palette di combinazione colori / superfici più completa nelle tinte neutre e naturali: tredici colori e quattro diverse superfici che si adattano alle diverse esigenze dell'abitare. Lo stesso colore può essere utilizzato dall'interno all'esterno, nei pavimenti e nei rivestimenti e per la realizzazione di piani cucina e mobili da bagno mantenendo una forte coerenza cromatica. Tutta la palette colori Concrete corrisponde ai colori Made 2.0; il colore White si abbina al Made 2.0 White Sand.





WALL | PARETE  
Concrete White Mat  
120x250 cm · 48"x100" #6 mm

FLOOR | PAVIMENTO  
Concrete White Soft  
120x120 cm · 48"x48" #12 mm

OUTDOOR FLOOR | PAVIMENTO ESTERNO  
Made 2.0 White Sand Bocciardato R11  
120x120 cm · 48"x48" #12 mm





WALL | PARETE  
Concrete Rope Mat  
120x250 cm · 48"x100" #6 mm

FLOOR | PAVIMENTO  
Concrete Rope Mat  
120x120 cm · 48"x48" #12 mm

COUNTER TOP | TOP BANCONE  
Concrete Rope Mat  
Gigacer Service #6 mm

COUNTER | BANCONE  
Concrete Iron - Rope Mat  
Gigacer Service #6 mm

COFFEE TABLE COUNTER TOP | PIANO DEI TAVOLINI  
Concrete Iron Mat  
Gigacer Service #4.8 mm

WALL | PARETE  
Concrete Black Mat  
120x250 cm · 48"x100" #6 mm

FLOOR | PAVIMENTO  
Concrete Pure - Black Mat  
120x120 cm · 48"x48" #6 mm





# Concrete

## COLOURS

COLORI

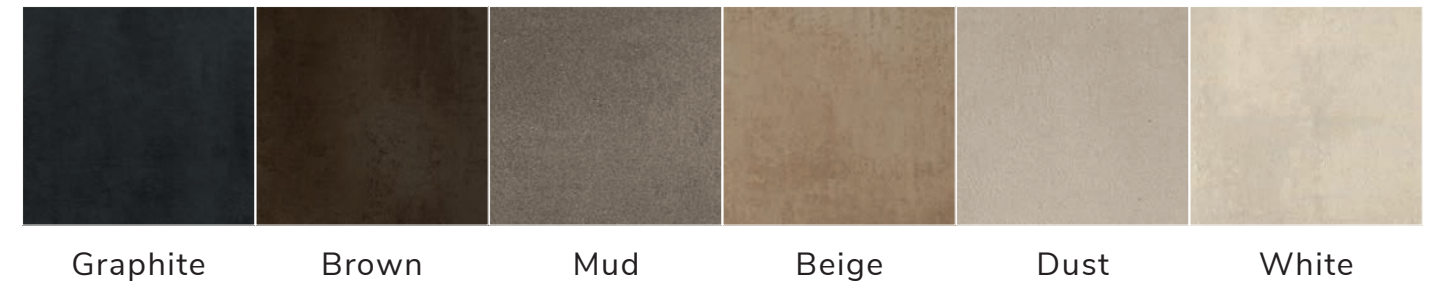

These pictures portray a portion of the slabs only.  
Le immagini rappresentate riproducono una porzione delle lastre.

\*Notes / Note:  
Available size 120x250  
rectified / unrectified  
through body or  
rectified multilayer in  
colours / disponibile  
il formato 120x250  
rettificato/non rettificato  
tutta massa o rettificato  
multistrato nei colori :  
Rope / Grey / Graphite  
/ Mud / White.

## SIZES AND THICKNESSES

FORMATI E SPESSORI

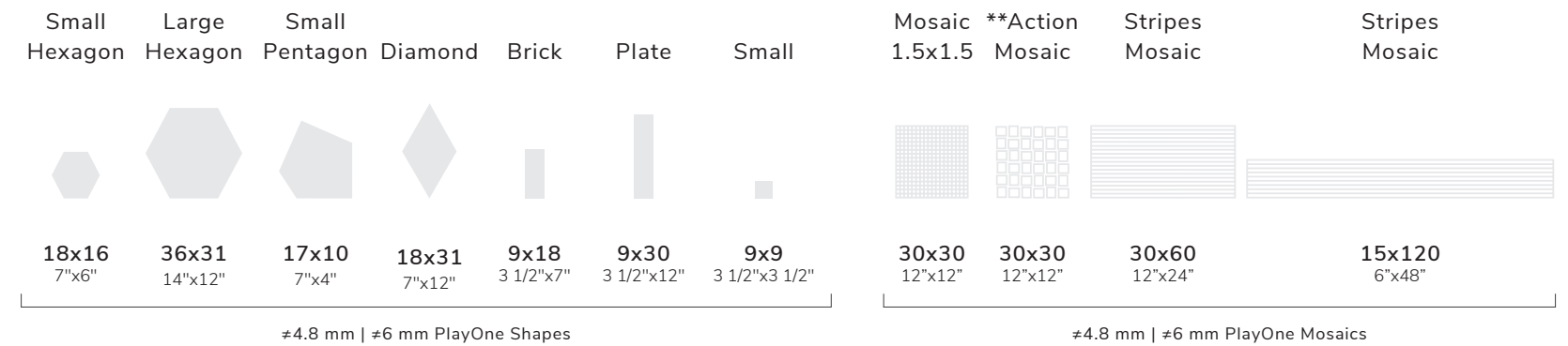
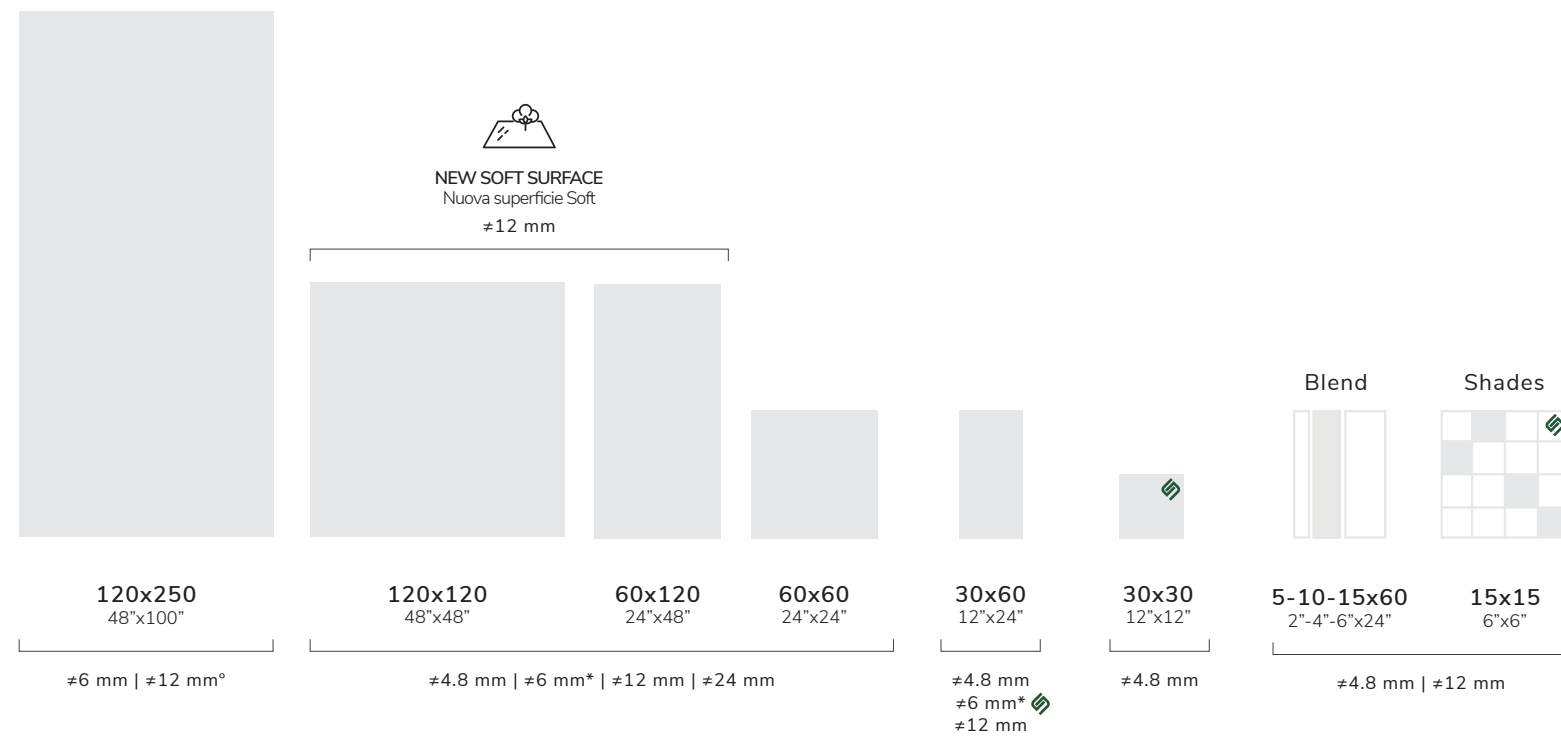
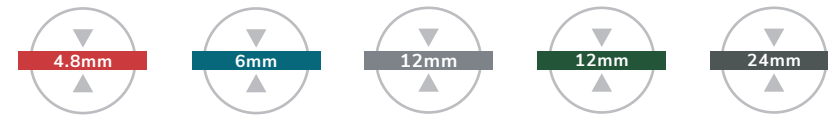

\*The colours Pure and Black are available in through body #6 mm only in the following sizes / I colori Pure e Black sono disponibili solo tutta massa #6 mm nei formati: 120x250, 120x120, 60x120, 60x60, 30x60 Gigacer Service, Mosaic 30x30, Stripes Mosaic and all PlayOne Shapes.

\*\*Action Mosaic is available in the following colours / Action Mosaic è disponibile nei colori: Ice, Rope, Grey, Graphite, White.

# Concrete Signs

## Design Surround

With its new Signs decoration the Concrete range is extending to include a sophisticated, stylish product. Four delicate weaves enrich the original material's aesthetic and decorative value.

## Design Surround

Con il nuovo decoro Signs, la linea Concrete amplia la propria gamma aggiungendo un prodotto dall'aspetto raffinato ed elegante. Quattro trame delicate arricchiscono la materia originale valorizzandone la valenza estetica e decorativa.





WALL | PARETE  
Concrete Signs Cubes Graphite  
120x250 cm · 48"x100" #6 mm  
Concrete Graphite Mat  
120x250 cm · 48"x100" #6 mm

FLOOR | PAVIMENTO  
Concrete Graphite Mat  
Small Hexagon 18x16 cm · 7"x6" #4.8 mm  
Concrete White Mat  
Small Hexagon 18x16 cm · 7"x6" #4.8 mm

KITCHEN TOP | TOP CUCINA  
Concrete White Mat through body | tutta massa  
Gigacer Service #12 mm





WALL | PARETE  
Concrete Signs Leaves Mud  
120x250 cm · 48"x100" #6 mm

FLOOR | PAVIMENTO  
Concrete Mud Soft  
120x120 cm · 48"x48" #12 mm

WALL | PARETE  
Concrete Signs Essential Smoke  
60x120 cm · 24"x48" #4.8 mm

PILLAR | COLONNA  
Concrete Signs Essential Smoke  
Gigacer Service #6 mm

OUTDOOR FLOOR | PAVIMENTO ESTERNO  
Made 2.0 Smoke Bocciardato R11  
60x120 cm · 24"x48" #12 mm

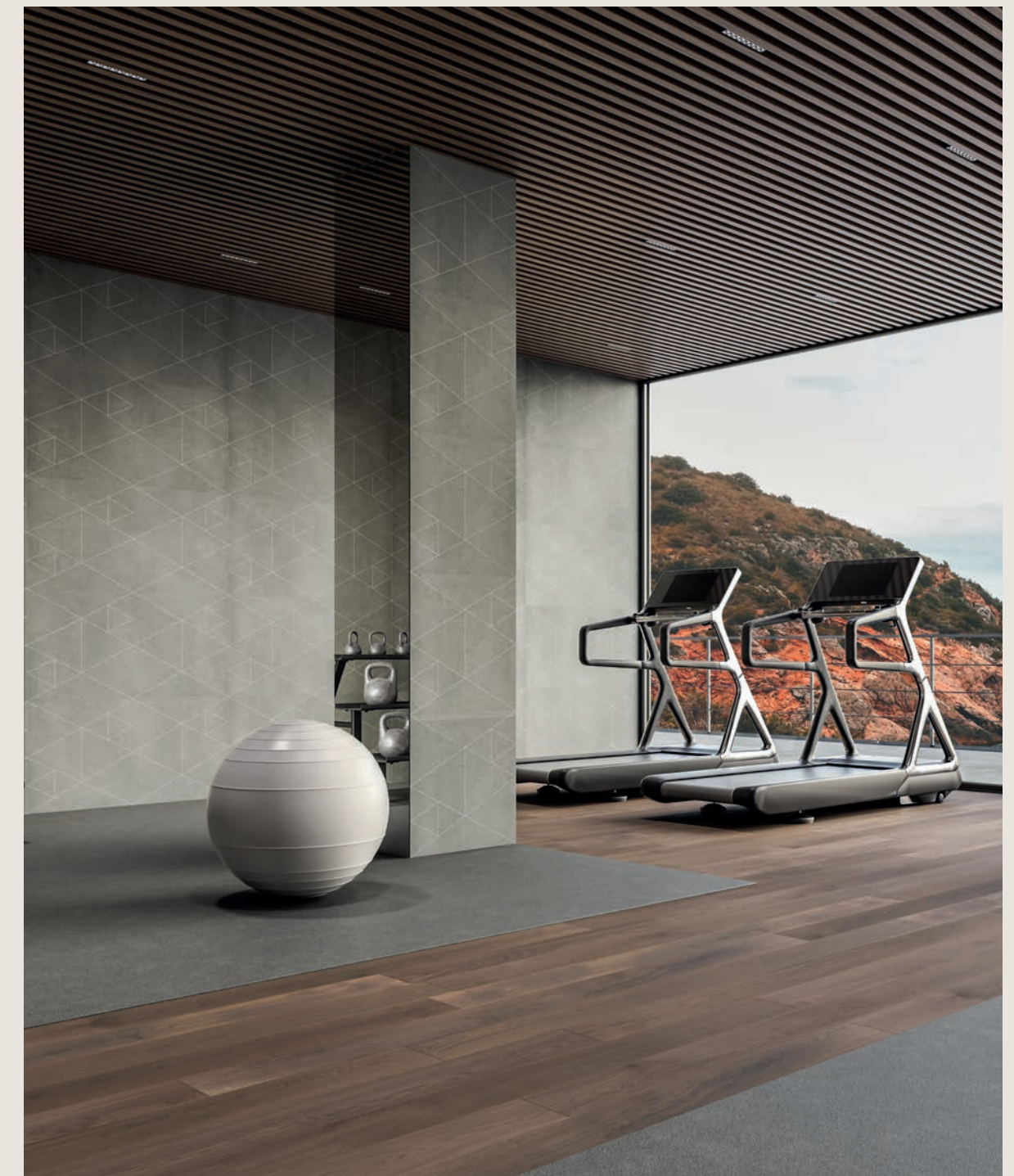



# Concrete Signs

## COLOURS

COLORI



These pictures portray a portion of the slabs only.  
Le immagini rappresentate riproducono una porzione delle lastre.

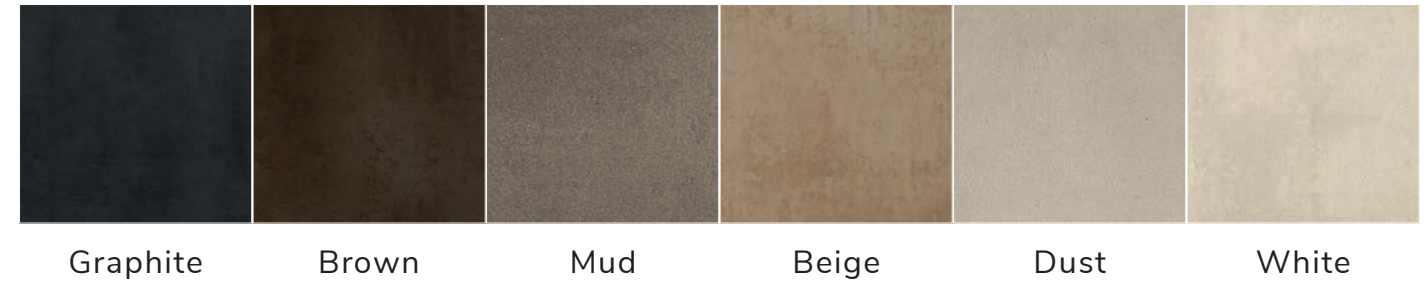

## SIZES AND THICKNESSES

FORMATI E SPESSORI

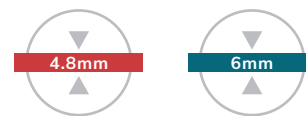

Notes / Note:

The product's technical features are not altered by the laser,  
in fact Concrete Signs can be laid on the floor.  
Il laser non altera le caratteristiche tecniche del prodotto,  
è infatti possibile posare Concrete Signs a pavimento.

\*The colours Pure and Black are available in through body #6 mm.  
\*\*Available in all the Concrete collection's colours (Pure - Ice - Rope - Grey - Iron - Smoke - Black - Graphite - Brown - Mud - Beige - Dust - White), the Signs decorations make for an especially delicate effect on the lighter colours such as White - Ice - Pure. On these pale colours Signs textures are visible only in specific light conditions, making for an extremely sophisticated look.

\*I colori Pure e Black sono disponibili solo tutta massa #6 mm.  
\*\*Disponibile in tutti i 13 colori della collezione Concrete (Pure - Ice - Rope - Grey - Iron - Smoke - Black - Graphite - Brown - Mud - Beige - Dust - White), il decoro Signs ottiene un effetto particolarmente delicato nelle tonalità più chiare, ovvero White - Ice - Pure. Declinate su questi colori tenui, le trame di Signs si apprezzano solo in particolari condizioni luminose, donando al prodotto un aspetto estremamente raffinato.



## TEXTURES

TRAME

Available in all series colours.\*\*  
Disponibile in tutti i colori della serie.\*\*

Buds

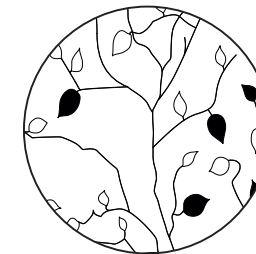

Leaves

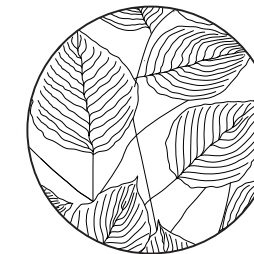

Cubes

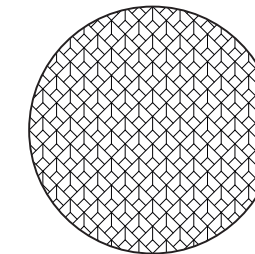

Essential

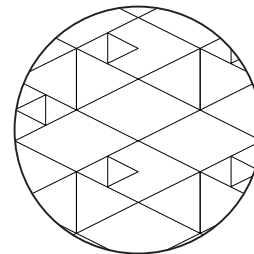

## LAYOUT

LAYOUT

### 1. LAYOUT CONCRETE SIGNS LEAVES

LEAVES GRAPHIC A

LEAVES GRAPHIC B

LEAVES GRAPHIC C

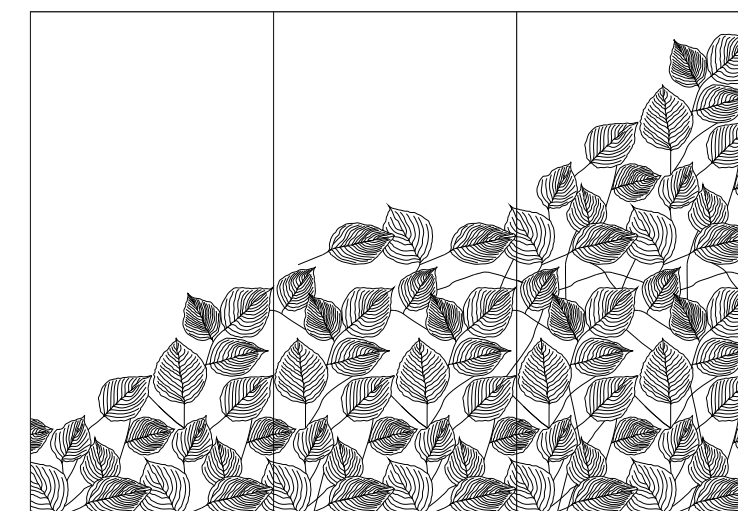

### 2. LAYOUT CONCRETE SIGNS BUDS

BUDS GRAPHIC A

BUDS GRAPHIC B

BUDS GRAPHIC C

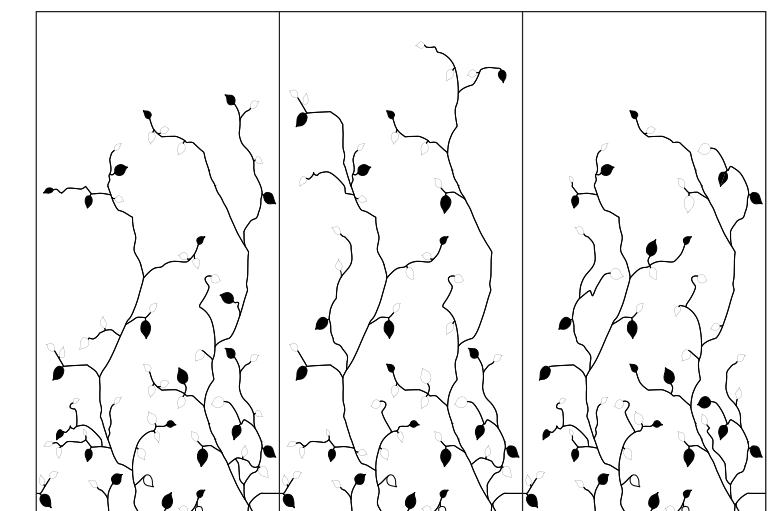



# Elementa

The new aesthetic of stone

The evolution of stone through past, present and future. The aesthetic of the new Elementa line celebrates the unpredictable beauty of nature, reinventing the signs of the past with the help of technology. A material that evolves, forever transforming itself into something unique and inimitable, Elementa perfectly fuses the technicity and performance typical of Gigacer porcelain stoneware and the precision of researched and carefully considered digital design that perfects and enriches the product.

The new aesthetic of stone

L'evoluzione della pietra, tra passato, presente e futuro. L'estetica della nuova linea Elementa celebra la bellezza imprevedibile della natura, reinventando i segni del passato grazie alla tecnologia. Materia che evolve e si trasforma, sempre unica e irripetibile, Elementa è la perfetta fusione tra la tecnicità e le performance del gres porcellanato tipico di Gigacer e la precisione di uno studiato e attento disegno digitale che perfeziona e arricchisce il prodotto.





WALL | PARETE  
Elementa Ivory Stone Soft  
120x120 cm · 48"x48" #6 mm

FLOOR | PAVIMENTO  
Elementa Ivory Stone Soft  
120x250 cm · 48"x100" #6 mm

FIREPLACE | CAMINO  
Concept 1 Ink Levigato  
Gigacer Service #6 mm

OUTDOOR FLOOR | PAVIMENTO ESTERNO  
Elementa Cool Stone Bocciardato R11  
60x120 cm · 24"x48" #20 mm







WALL | PARETE  
 Elementa Cool Stone Mat  
 120x250 cm · 48"x100" #6 mm

FLOOR | PAVIMENTO  
 Elementa Cool Stone Mat  
 60x120 cm · 24"x48" #6 mm

WASHBASIN | LAVABO  
 Elementa Cool Stone Mat  
 Gigacer Service #6 mm

OUTDOOR FLOOR | PAVIMENTO ESTERNO  
 Elementa Cool Stone Bocciardato R11  
 60x120 cm · 24"x48" #20 mm

WALL | PARETE  
 Elementa Warm Stone Mat  
 Chevron Mosaic 30x30 cm · 12"x12" #6 mm  
 Elementa Warm Stone Mat  
 120x250 cm · 48"x100" #6 mm

SHOWER TRAY | PIATTO DOCCIA  
 Elementa Warm Stone Mat  
 Mosaic 1.5x1.5 30x30 cm · 12"x12" #6 mm





# Elementa

## COLOURS

COLORI



Ivory Stone Warm Stone Cool Stone

These pictures portray a portion of the slabs only.  
Le immagini rappresentate riproducono una porzione delle lastre.

## SURFACES

SUPERFICI

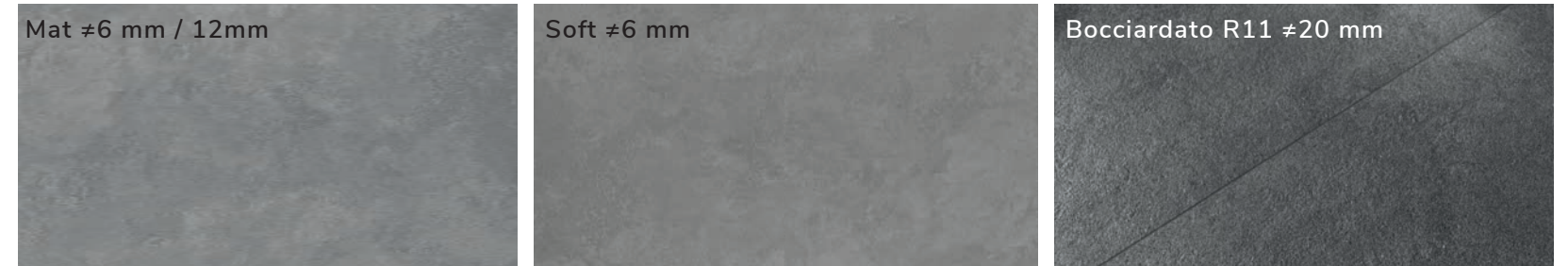

## SIZES AND THICKNESSES

FORMATI E SPESSORI

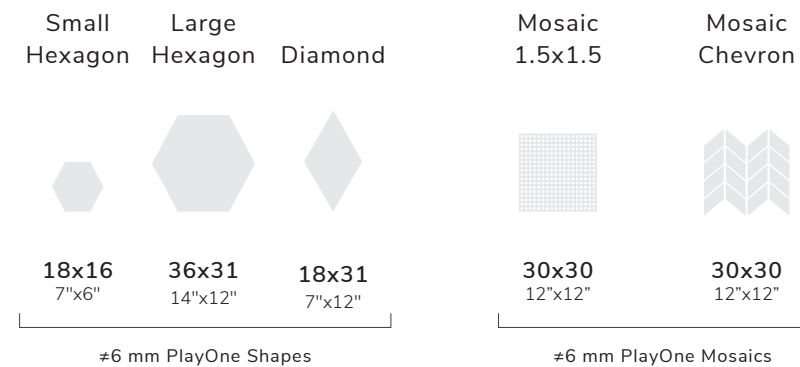
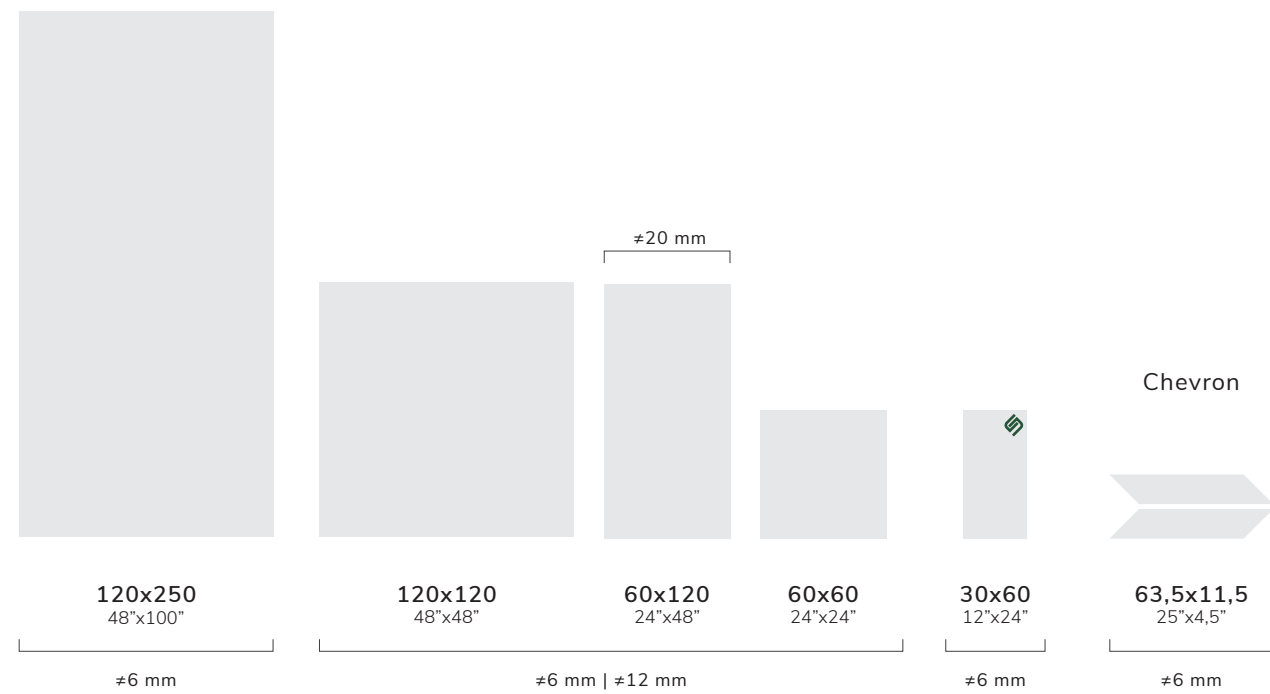



# Gatsby

Style, refinement and versatility.

Small sparks with a vibrant and dynamic effect elegantly feature the surface, giving life to a modern and refined geometric pattern. The signs in relief on the material surface create a texture with endless stylistic and semantic values, transforming an apparently simple product into a perfect mix of decorative style, contemporary appeal and timeless elegance. The deep and diversified chromatic range generates new vibrations of shape and color, becoming a passepartout to create infinite combinations.

Stile, raffinatezza e versatilità.

Piccole scintille dall'effetto vibrante e dinamico percorrono elegantemente la superficie dando vita ad un pattern geometrico moderno e raffinato. I segni a rilievo sulla superficie materica creano una trama dalle infinite valenze stilistiche e semantiche, trasformando un prodotto apparentemente semplice in un mix perfetto tra stile decorativo, appeal contemporaneo ed eleganza senza tempo.

La gamma cromatica profonda e diversificata genera nuove vibrazioni di forma e colore e diventa un passe-partout per creare infinite combinazioni.





WALL | PARETE  
Gatsby Old Yellow  
120x250 cm · 48"x100" #6 mm  
Concrete Iron Mat  
120x250 cm · 48"x100" #6 mm

FLOOR | PAVIMENTO  
Concrete Iron Mat  
120x120 cm · 48"x48" #12 mm







WALL | PARETE  
 Gatsby Long Island  
 120x250 cm · 48"x100" #6 mm  
 Concrete Brown  
 120x250 cm · 48"x100" #6 mm

FLOOR | PAVIMENTO  
 Concrete Rope Soft  
 120x120 cm · 48"x48" #12 mm

WALL | PARETE  
 Gatsby Green Light  
 120x250 cm · 48"x100" #6 mm





# Gatsby

## COLOURS

COLORI

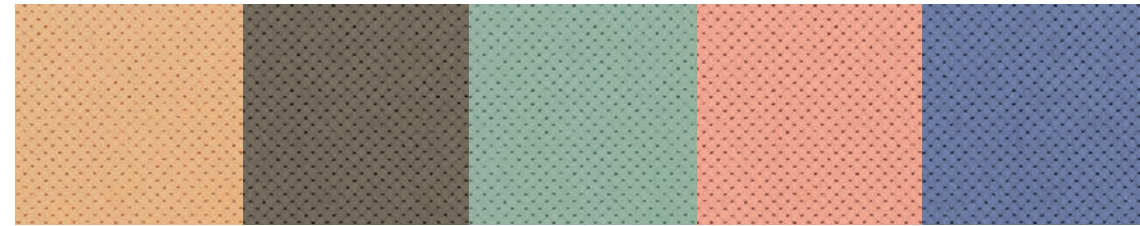

Old Yellow Long Island Green Light Charleston Jazz

These pictures portray a portion of the slabs only.  
Le immagini rappresentate riproducono una porzione delle lastre.

## SIZES AND THICKNESSES

FORMATI E SPESSORI



120x250  
48"x100"

120x120  
48"x48"

60x120  
24"x48"

±6 mm



WALL | PARETE  
Gatsby Charleston  
120x250 cm · 48"x100" ±6 mm



# Inclusioni Classico

Between vintage accents and classical references, Inclusioni Classico's eclectic character adapts to different styles of interior design, fitting with elegance and personality into modern and contemporary settings, to whom it lends a timeless and refined elegance.

Tra accenti vintage e richiami classicheggianti, il carattere eclettico di Inclusioni Classico si adatta a diversi stili di interior design, inserendosi con eleganza e personalità in contesti moderni e contemporanei, ai quali conferisce un'eleganza intramontabile.





FLOOR | PAVIMENTO  
Inclusioni Classico Rosso - Ocra - Nero - Grigio Mat  
Gigacer Service #12 mm

BLOCKS | CUBI  
Inclusioni Classico Nero - Grigio Mat  
Gigacer Service #12 mm  
Concrete Pure - Black Mat  
Gigacer Service #6 mm





**FLOOR | PAVIMENTO**  
 Inclusioni Classico Avorio - Nero Levigato  
 120x120 cm · 48"x48" #12 mm  
 Inclusioni Classico Avorio - Nero Levigato  
 30x120 cm · 12"x48"  
 Gigacer Service #12 mm  
 Inclusioni Classico Avorio - Nero Levigato  
 30x30 cm · 12"x12"  
 Gigacer Service #12 mm

**FLOOR | PAVIMENTO**  
 Inclusioni Classico Ocra - Terra Mat  
 120x120 cm · 48"x48" #12 mm  
 Inclusioni Classico Avorio Mat  
 60x120 cm · 24"x48" #12 mm

**TABLE | TAVOLO**  
 Inclusioni Classico Avorio Levigato through body | tutta massa  
 Gigacer Service #12 mm





# Inclusioni Classico

## COLOURS

COLORI

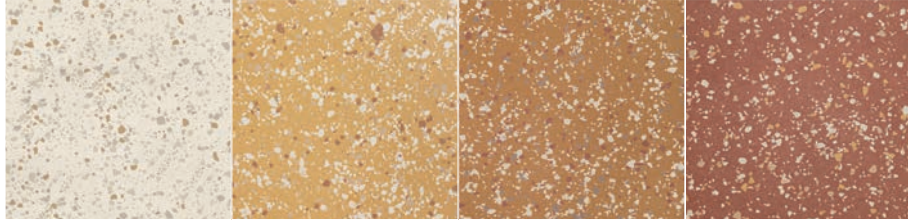

\*Avorio      Odra      Ambra      \*Rosso

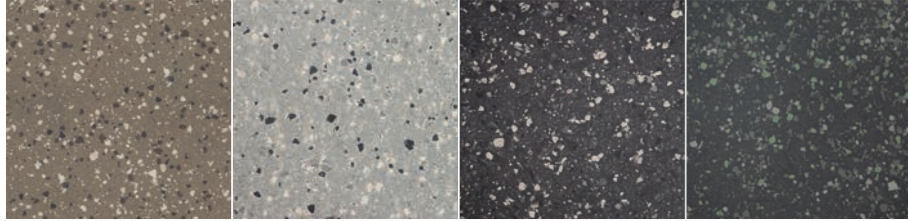

Terra      Grigio      \*Nero      Nero Giada

These pictures portray a portion of the slabs only.  
Le immagini rappresentate riproducono una porzione delle lastre.

\*The colours Avorio, Rosso and Nero are available in through body #12 mm only in 120x250 cm / I colori Avorio, Rosso e Nero sono disponibili solo tutta massa #12mm nel formato 120x250 cm.

## SIZES AND THICKNESSES

FORMATI E SPESSORI

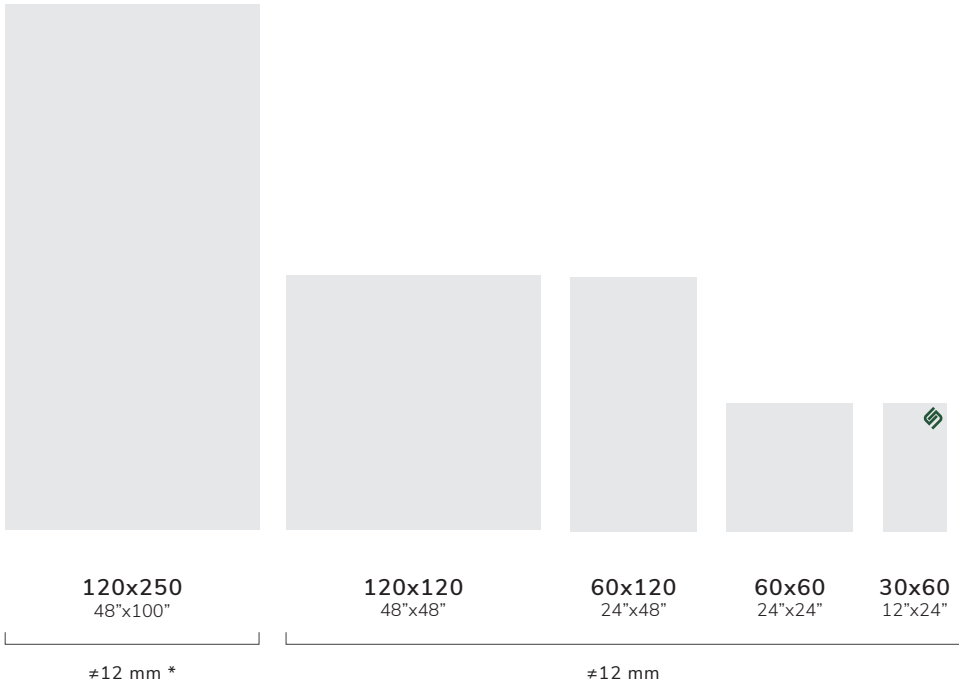

## SURFACES

SUPERFICI

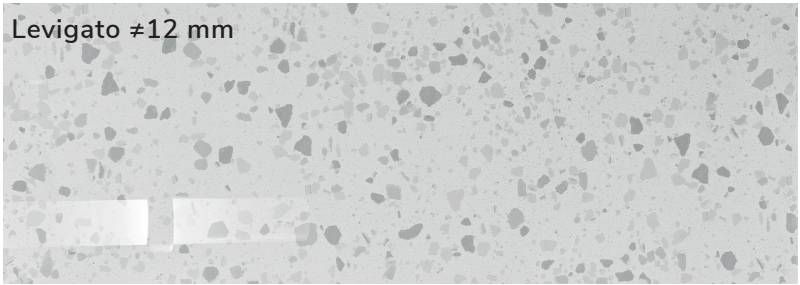
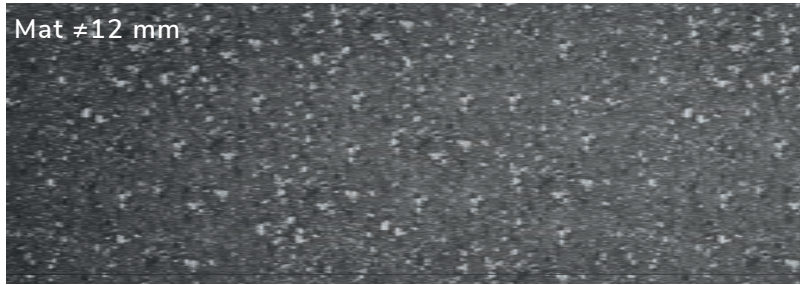



# Inclusioni Soave

A meeting between contemporary aesthetics and timeless elegance. The power of time which amalgamates and smoothes surfaces: the elegance of the series Inclusioni.

Inspired by the force of the nature, Inclusioni is an encounter between contemporary aesthetics and timeless elegance. Surfaces are authentically material and refined: porcelain stoneware flakes produced under the skilful control of our laboratory technicians are deposited on the surface and incorporated; the result is a tangible and three-dimensional effect.

Un incontro tra estetica contemporanea ed eleganza senza tempo. La potenza del tempo che amalgama e leviga le superfici: l'eleganza delle inclusioni.

Ispirata dalla forza paziente della natura, Inclusioni è un incontro tra estetica contemporanea ed eleganza senza tempo. Le sue superfici sono autenticamente materiche e raffinate: scaglie in gres porcellanato prodotte sotto il sapiente controllo dei tecnici del nostro laboratorio vengono deposte sulla superficie e inglobate; il risultato è un effetto tangibile e tridimensionale.





FLOOR | PAVIMENTO  
Inclusioni Soave Bianco Perla Soft  
120x120 cm · 48"x48" #12 mm







FLOOR | PAVIMENTO  
 Inclusioni Soave Ecrù Mat  
 120x120 cm · 48"x48" #12 mm

OUTDOOR FLOOR | PAVIMENTO ESTERNO  
 Inclusioni Soave Ecrù Bocciardato R11  
 120x120 cm · 48"x48" #12 mm

FLOOR | PAVIMENTO  
 Inclusioni Soave Tabacco Mat  
 120x120 cm · 48"x48" #12 mm





# Inclusioni Soave

## COLOURS

COLORI



Bianco Perla    Ecrù    Tabacco    Cenere    Vulcano

## SIZES AND THICKNESSES

FORMATI E SPESSORI

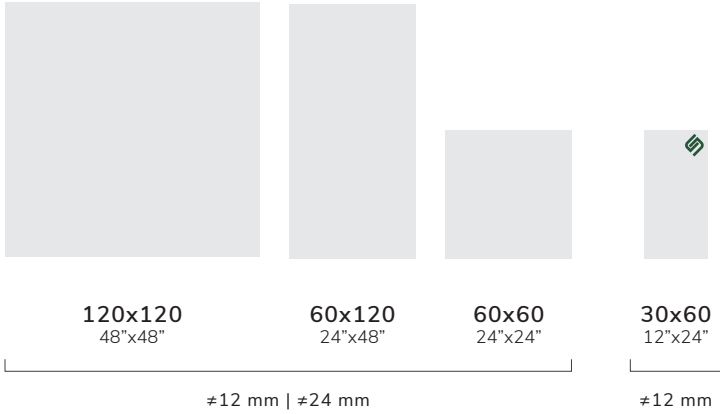

## SURFACES

SUPERFICI

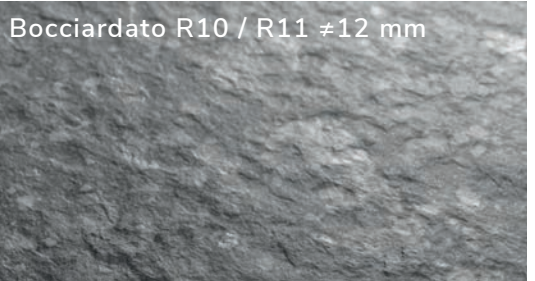
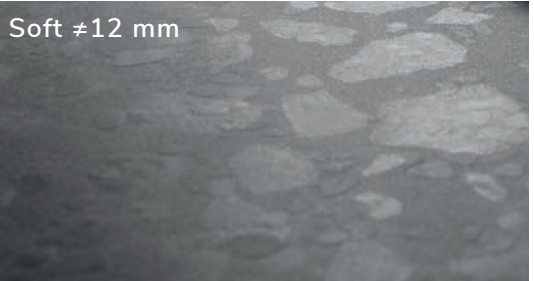
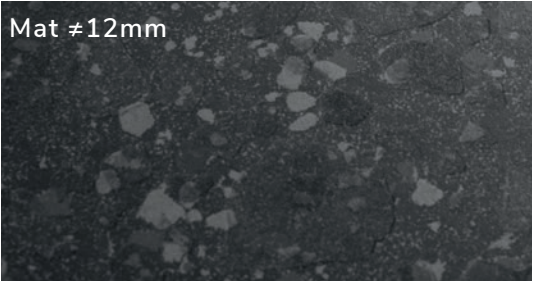

Notes / Note:  
Available Bocciardato R10 and R11 surface, specify in the order / Disponibile nella superficie Bocciardato R10 e R11, specificare nell'ordine.



# Krea

## Colours and materials

Eight colours that interpret cements and coloured resins in a modern way. Krea range allows you to use bright colors and bold shades both in residential and in public projects, thanks to the high technical characteristics provided by the unglazed porcelain stoneware. A solution with a decisive character, suitable for contemporary living.

## Colori e materia

Otto colori che interpretano la materia dei cementi e delle resine colorate in chiave moderna. La serie Krea consente di utilizzare colori vivaci e sfumature decise, oltre che in ambito residenziale, anche nei progetti pubblici, grazie alle elevate caratteristiche tecniche fornite dal gres porcellanato rigorosamente non smaltato. Una soluzione dal carattere deciso, adeguata all'abitare contemporaneo.











**WALL | PARETE**  
 Krea Ground - Orange  
 Large Hexagon 36x31 cm · 14"x12" #4.8 mm  
 Krea Orange  
 Mosaic 1.5x1.5 30x30 cm · 12"x12" #4.8 mm  
 Krea Orange  
 120x250 cm · 48"x100" #6 mm

**FLOOR | PAVIMENTO**  
 Krea Ground  
 120x120 cm · 48"x48" #4.8 mm  
 Krea Orange  
 Mosaic 1.5x1.5 30x30 cm · 12"x12" #4.8 mm

**WALL | PARETE**  
 Krea Blue  
 60x120 cm · 24"x48" #4.8 mm

**WASHBASIN | LAVABO LEFT**  
 Krea Blue  
 119x50 cm · 48"x19 1/2"  
 Gigacer Service #4.8 mm





# Krea

## COLOURS

COLORI



Ground Nut Silver \*Snow

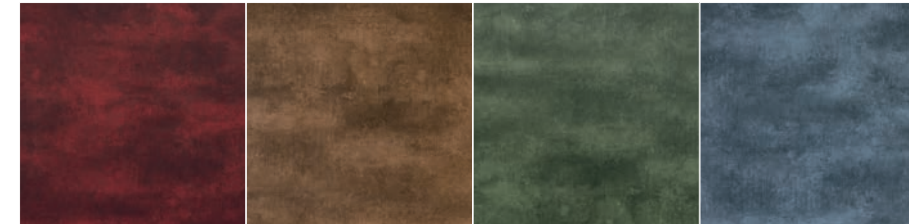

Red \*Orange \*Green \*Blue

These pictures portray a portion of the slabs only.  
Le immagini rappresentate riproducono una porzione delle lastre.

\*The 120x250cm slab is only available in the following colours: / La lastra 120x250cm è disponibile solamente nei seguenti colori: **Blue, Orange, Green, Snow.**

## SIZES AND THICKNESSES

FORMATI E SPESSORI

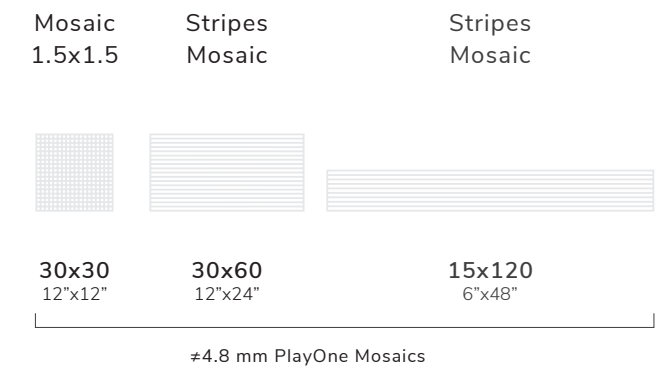
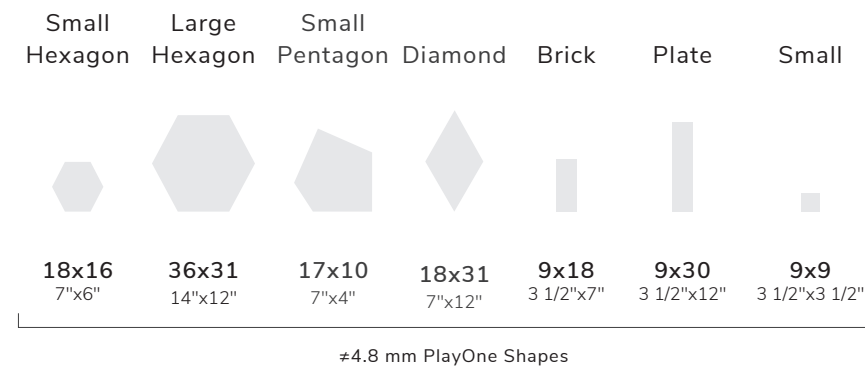
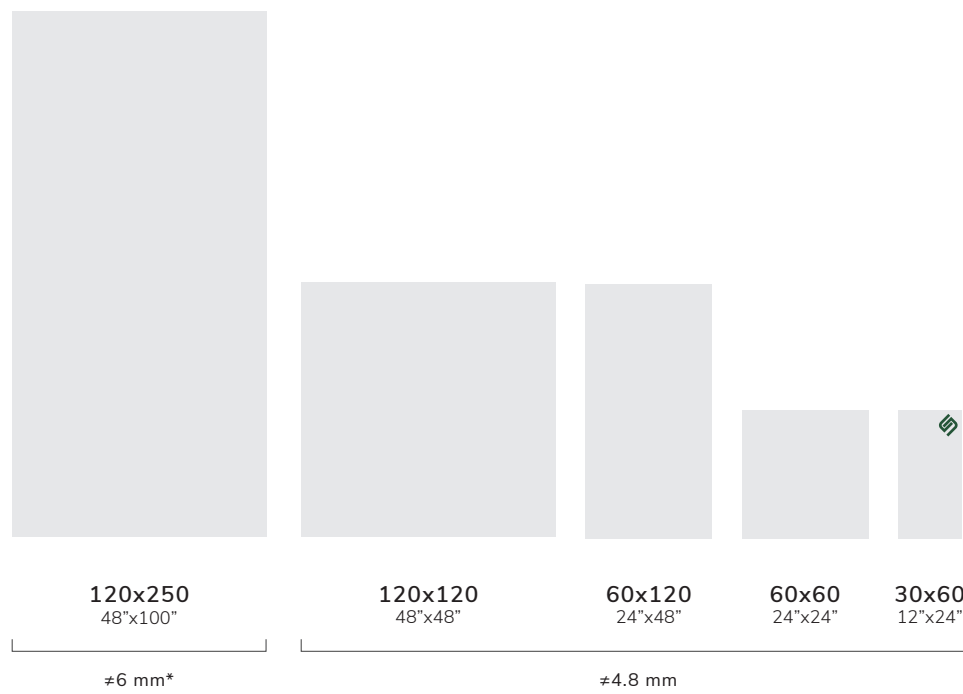
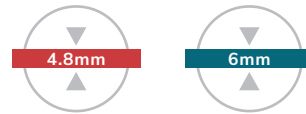



# Light

## White in architecture

An innovative system of white porcelain stoneware materials centered on light and on texture: Light. It is light that transforms these five textural surfaces, enhancing their expressive variety. Light is also the material: light, because this completely white range is composed by a thin thickness of pure white matter.

## Bianco in architettura

Un innovativo sistema di materiali in gres porcellanato che gioca con la luce e con la materia: Light. È la luce ad evidenziare la struttura materica delle cinque superfici, esaltandone la varietà plastica espressiva. Light è anche la materia: leggera, perché questa gamma completamente bianca è formata da uno spessore sottile di pura materia candida.





WALL | PARETE  
Light 250 Piquet  
60x250 cm · 24"x100" #6 mm  
Gigacer Service

Light Blend  
15x60 cm · 6"x24" #6 mm  
Gigacer Service

Concrete Beige Mat  
120x250 cm · 48"x100" #6 mm

FLOOR | PAVIMENTO

Light Gesso  
120x120 cm · 48"x48" #6 mm

Concrete Beige Mat  
Mosaic 1.5x1.5 30x30 cm · 12"x12" #4.8 mm







**WALL | PARETE**

Light Mix  
 Mosaic 1.5x1.5 30x30 cm · 12"x12" #6 mm  
 Light 250 Curtain  
 120x250 cm · 48"x100" #6 mm

**FLOOR | PAVIMENTO**

Light Gesso  
 120x120 cm · 48"x48" #6 mm  
 Light Blend  
 20x20 cm · 8"x8" #6 mm  
 Gigacer Service

**FLOOR | PAVIMENTO**  
 Light Rigato - Scolpito - Roccia - Crespo  
 60x60 cm · 24"x24" #6 mm





# Light

## COLOURS / SURFACES

COLORI / SUPERFICI



Crespo      Gesso      Rigato      Roccia      Scolpito

These pictures portray a portion of the slabs only.  
Le immagini rappresentate riproducono una porzione delle lastre.

## SIZES AND THICKNESSES

FORMATI E SPESSORI



Notes / Note:  
The following sizes are available in surfaces mix: 15x20 cm/ 6"x24" - 20x20 cm/ 8"x8".  
I seguenti formati sono disponibili anche con un mix di superfici: 15x20 cm/ 6"x24" - 20x20 cm/ 8"x8".

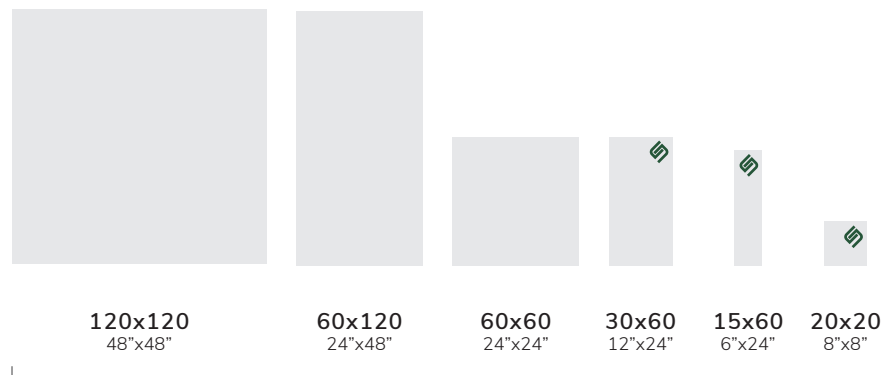

±6 mm

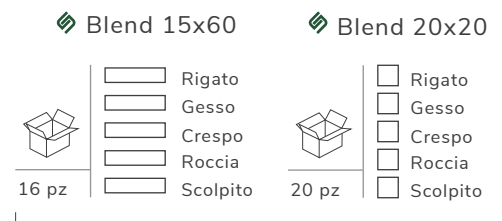

±6 mm

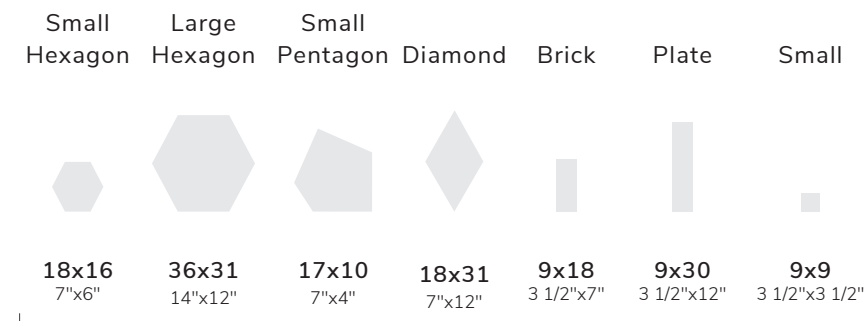

±6 mm PlayOne Shapes

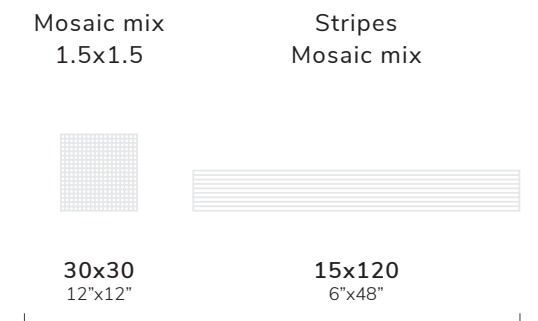

±6 mm PlayOne Mosaics



# Light 250

White in architecture

Lightness is our inspiration. The refined cotton weaving, the subtle transparencies and the soft mat white crystallize in the wall.

Bianco in architettura

La luce è la nostra ispirazione. La raffinata tessitura del cotone, le sottili trasparenze e il morbido bianco opaco si cristallizzano nella parete.





WALL | PARETE  
Light 250 Curtain  
120x250 cm · 48"x100" #6 mm  
Argilla Vetiver Material  
60x120 cm · 24"x48" #6 mm  
Argilla Vetiver Material  
Stripes Mosaic 15x120 cm · 6"x48" #6 mm

FLOOR | PAVIMENTO  
Argilla Vetiver Material  
120x120 cm · 48"x48" #6 mm







WALL | PARETE  
Light 250 Curtain  
120x250 cm · 48"x100" #6 mm

FLOOR | PAVIMENTO  
Argilla Vetiver Material  
120x120 cm · 48"x48" #6 mm

WALL | PARETE  
Light 250 Twill  
120x250 cm · 48"x100" #6 mm





# Light 250

## COLOURS / SURFACES

COLORI / SUPERFICI



Curtain

Piquet

Twill

## SIZES AND THICKNESSES

FORMATI E SPESSORI

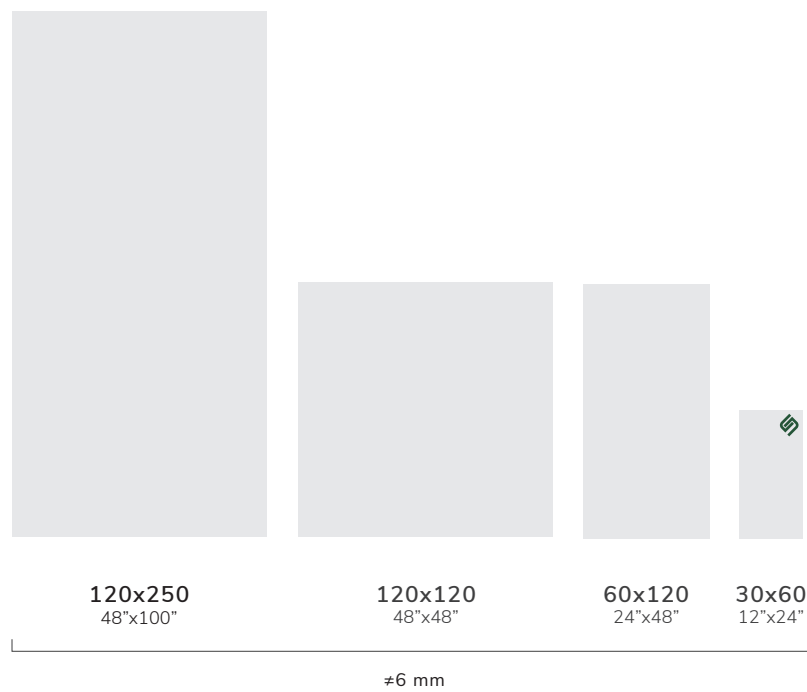

These pictures portray a portion of the slabs only.  
Le immagini rappresentate riproducono una porzione delle lastre.



### WALL | PARETE

Light 250 Piquet

120x250 cm · 48"x100" #6 mm

Concrete Ice Mat

120x250 cm · 48"x100" #6 mm

### KITCHEN TOP | TOP CUCINA

Concrete Mud Mat through body | tutta massa

Gigacer Service #12 mm



# Made 2.0

## Surround Design

Made 2.0, in synergy with Concrete, is a flexible ceramic system used for living spaces. It is the most complete color/ surface combination palette in neutral and natural shades: eleven colours and four different surface that could be adapted to the different needs of living. The same colour could be used from the indoor to the outdoor, in floors and covering and for the creation of kitchen tops and bathroom furniture while maintaining a strong chromatic coherence. All the Made 2.0 Palette corresponds to the Concrete colours. The White Sand colour can be combined with the Concrete White.

## Design Surround

Made 2.0, in sinergia con Concrete, è un flessibile sistema ceramico a servizio degli spazi abitativi. È la palette di combinazione colori/superfici più completa nelle tinte neutre e naturali: undici colori e quattro diverse superfici che si adattano alle diverse esigenze dell'abitare. Lo stesso colore può essere utilizzato dall'interno all'esterno, nei pavimenti e nei rivestimenti e per la realizzazione di piani cucina e mobili da bagno mantenendo una forte coerenza cromatica. Tutta la palette Made 2.0 corrisponde ai colori Concrete. Il colore White Sand si abbina al Concrete White.





FLOOR | PAVIMENTO  
Made 2.0 White Sand Mat  
120x120 cm · 48"x48" #12 mm







FLOOR | PAVIMENTO  
Made 2.0 Mud Levigato  
120x120 cm · 48"x48" #12 mm

OUTDOOR FLOOR | PAVIMENTO ESTERNO  
Made 2.0 Mud Bocciardato R11  
120x120 cm · 48"x48" #12 mm

FLOOR | PAVIMENTO  
Made 2.0 Dust Bocciardato R11  
60x120 cm · 24"x48" #12 mm





# Made 2.0

## COLOURS

COLORI



Ice Rope Grey Iron Smoke Graphite

These pictures portray a portion of the slabs only.  
Le immagini rappresentate riproducono una porzione delle lastre.

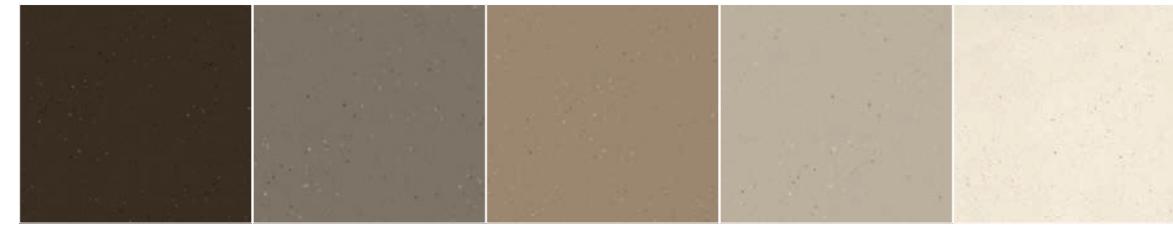

Brown Mud Beige Dust White

\* Notes / Note:  
Available size 120x250  
in the following colours  
/ disponibile il formato  
120x250 nei seguenti  
colori: Ice / Rope / Iron /  
Graphite.

## SIZES AND THICKNESSES

FORMATI E SPESSORI

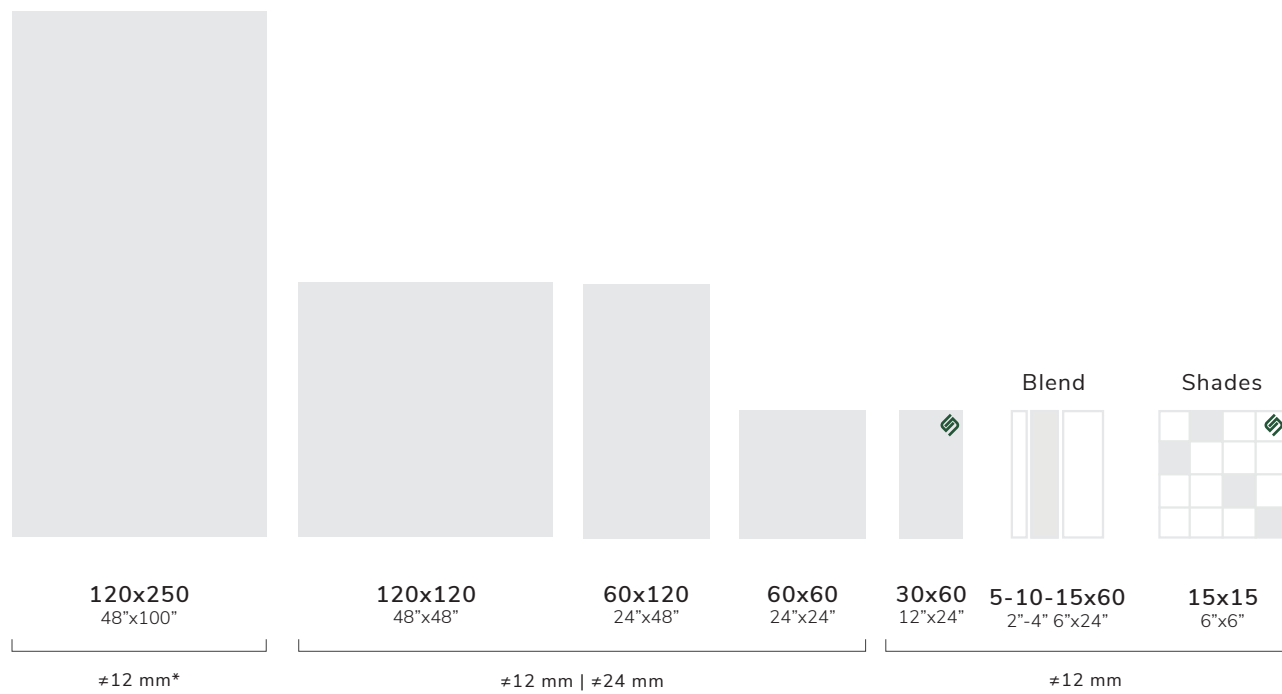
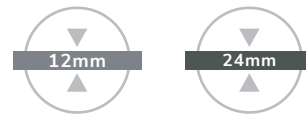

## SURFACES

SUPERFICI

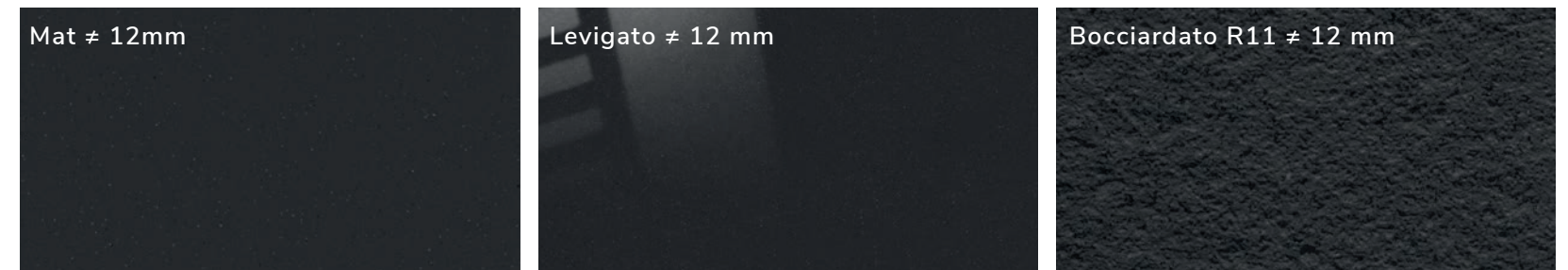

Notes / Note:  
All Made 2.0 levigato products are Gigacer Service /  
Tutti i prodotti Made 2.0 Levigato sono Gigacer Service



# Quarry

The best choice for nature

In strict respect for the environment typical of Gigacer, a series inspired by the solidity and strength of natural stone. Quarry offers great versatility: with its numerous formats and two different surfaces, mat R10 A+B and bocciardato antislip R11 A+B+C, it is suitable for both indoor and outdoor, residential and business contexts.

The best choice for nature

Nel rigoroso rispetto dell'ambiente tipico di Gigacer, una serie ispirata alla solidità e alla forza della pietra naturale. Quarry offre una grande versatilità: grazie ai numerosi formati e alle due diverse superfici, mat R10 A+B e bocciardato antiscivolo R11 A+B+C, è adatta agli ambienti interni, a quelli esterni, residenziali e commerciali.







WALL | PARETE  
Quarry Crema Marfil Mat  
120x250 cm · 48"x100" #6 mm

FIREPLACE | CAMINO  
Quarry Lava Stone Mat  
Gigacer Service #6 mm

FLOOR | PAVIMENTO  
Quarry Crema Marfil Mat  
120x120 cm · 48"x48" #6 mm

OUTDOOR FLOOR | PAVIMENTO ESTERNO  
Quarry Crema Marfil Bocciardato R11  
60x60 cm · 24"x24" #12 mm





WALL | PARETE  
 Quarry Golden Stone Mat  
 120x120 cm · 48"x48" #12 mm

FLOOR | PAVIMENTO  
 Quarry Golden Stone Bocciardato R11  
 Module | Modulo Gigacer Service #12 mm

WALL | PARETE  
 Quarry Arenaria Mat  
 60x120 cm · 24"x48" #12 mm

FLOOR | PAVIMENTO  
 Quarry Arenaria Bocciardato R11  
 120x120 cm · 48"x48" #12 mm  
 Quarry Arenaria Mat  
 60x120 cm · 24"x48" #12 mm





# Quarry

## COLOURS

COLORI



\*Quarzite Bianca    Arenaria    \*Gravel Stone    \*Crema Marfil    Golden Stone    \*Lava Stone

These pictures portray a portion of the slabs only.  
Le immagini rappresentate riproducono una porzione delle lastre.

\*Notes/ Note:  
Available thickness #6 mm in the following colours / disponibile lo spessore #6 mm nei seguenti colori:  
Quarzite Bianca / Gravel Stone / Crema Marfil / Lava Stone.

## SIZES AND THICKNESSES

FORMATI E SPESSORI

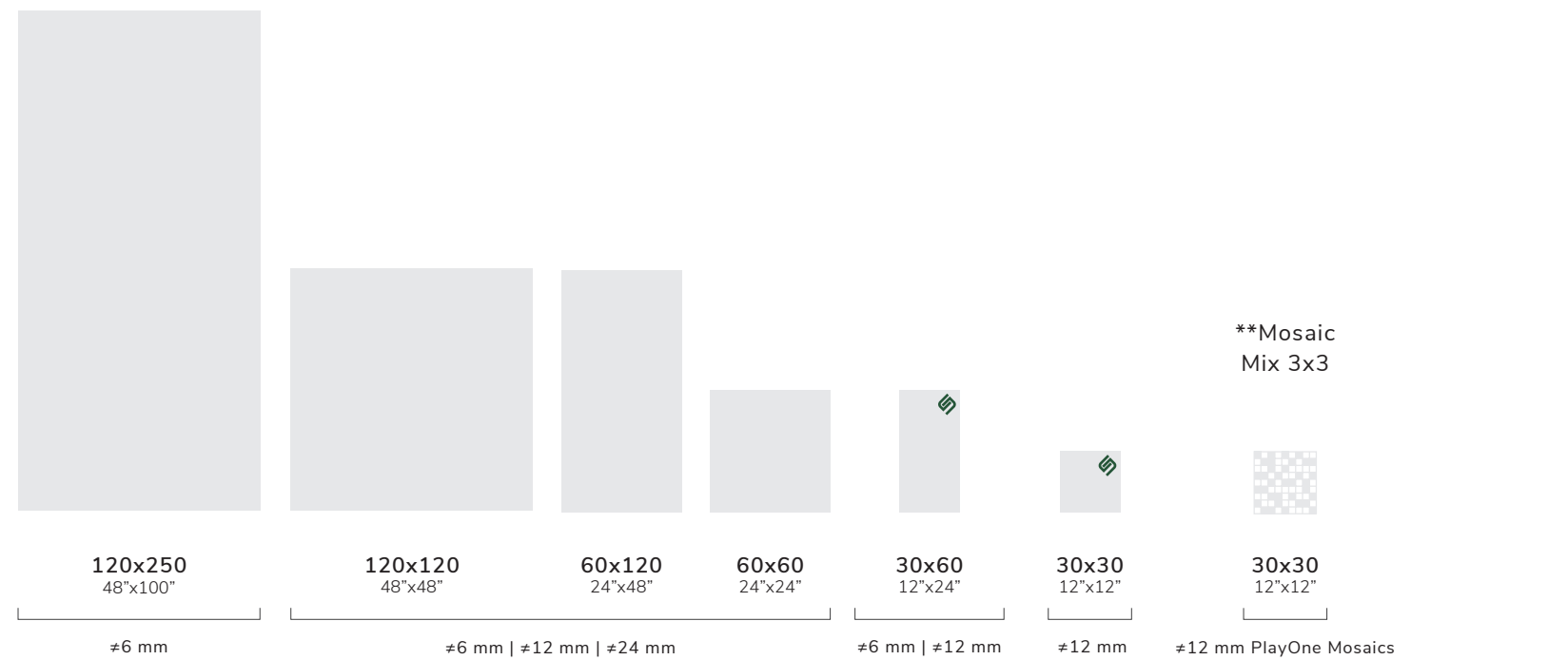

## SURFACES

SUPERFICI

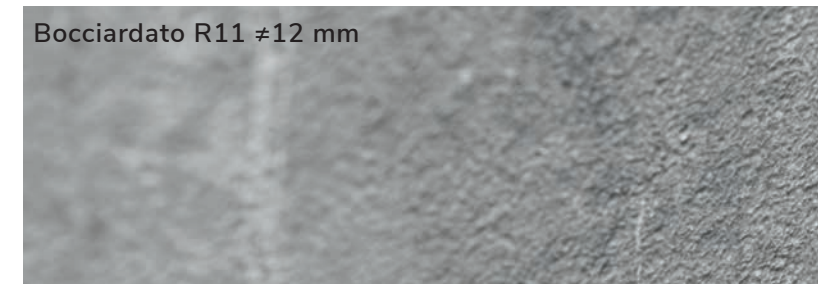

## SUGGESTED LAYOUT

POSA CONSIGLIATA

MODULE 2,70 Sqm MODULO 2,70 mq

Each module, that is composed of 2 pieces of 60x120, 2 pieces of 60x60, 2 pieces of 30x60 and 2 pieces of 30x30, is packed in a single box. / Ogni modulo, composto da 2 pezzi di 60x120, 2 pezzi di 60x60, 2 pezzi di 30x60 e 2 pezzi di 30x30, è contenuto in un'unica scatola.

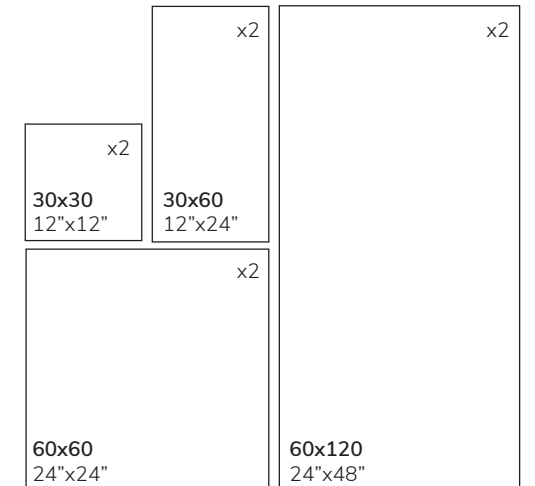



# Tele

## Creative decors

Geometries with a vintage charm and harmonious natural inspirations. A new line with an artistic spirit and extraordinary expressiveness, able to combine aesthetics and function. Thanks to the eloquence of the decorations, the new Tele slabs allow to create settings with a strong connotation, as unique as works of art. Eclectic and versatile, Tele completes and enriches the Gigacer range and can be easily combined with products with more neutral colours, paving the way for countless stylistic and compositional solutions.

## Decori creativi

Geometrie dal fascino vintage e armoniose ispirazioni naturali. Una nuova linea dallo spirito artistico e dalla straordinaria espressività, capace di coniugare estetica e funzione. Grazie all'eloquenza dei decori, le nuove lastre Tele permettono di creare ambienti dalla forte connotazione, unici come opere d'arte. Eclettico e versatile, Tele completa e arricchisce la gamma Gigacer ed è facilmente abbinabile a prodotti dalle cromie più neutre, aprendo la strada ad innumerevoli soluzioni stilistiche e compositive.







WALL | PARETE

Tele Autunno

60x120 cm · 24"x48" ±4.8 mm

FLOOR | PAVIMENTO

Concrete Graphite Mat

120x120 cm · 48"x48" ±4.8 mm





WALL | PARETE  
 Tele Geometrie Cielo  
 60x120 cm · 24"x48" #4.8 mm  
 Argilla Marine Material  
 60x120 cm · 24"x48" #6 mm

FLOOR | PAVIMENTO  
 Concrete Grey Mat  
 60x60 cm · 24"x24" #12 mm

WALL | PARETE  
 Tele Geometrie Terra  
 60x120 cm · 24"x48" #4.8 mm





# Tele

## COLOURS / SURFACES

COLORI / SUPERFICI



Autunno Fiorita Foresta Geometrie Cielo Geometrie Terra Primavera

These pictures portray a portion of the slabs only.  
Le immagini rappresentate riproducono una porzione delle lastre.

Notes / Note:  
Autunno, Geometrie Cielo, Geometrie Terra are cold glazed decorations / sono decorazioni a freddo.  
Foresta, Primavera, Fiorita are third fire decorations / sono decorazioni a caldo.

## SIZES AND THICKNESSES

FORMATI E SPESSORI

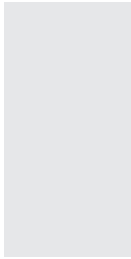

60x120  
24"x48"

±4.8 mm



WALL | PARETE  
Tele Foresta  
60x120 cm · 24"x48" ±4.8 mm

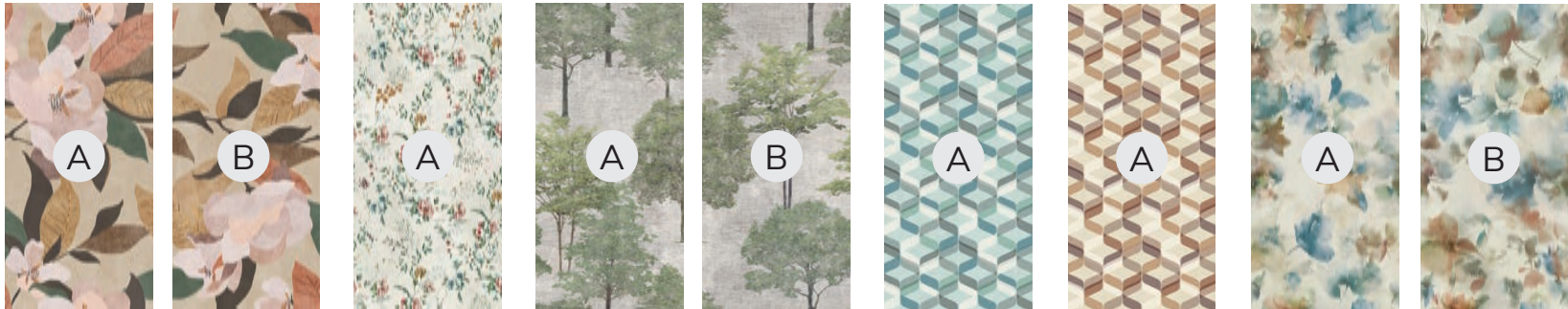



# Terra

## Essenza materica

The atavistic call of the primordial was the inspiration for the new Terra range, an essential, primitive look which conjures up nature's intrinsic characteristics, its resilience, irregularity and uniqueness. Matter dried by the sun, transformed by natural agents giving it the lived-in look telling of the passage of time and thus replete with memories and evocations.

## Essenza materica

Un prodotto dall'estetica essenziale, primitiva, che porta in sé le caratteristiche intrinseche della natura, la sua resistenza, irregolarità e unicità. Materia essiccata al sole, trasformata dagli agenti naturali che le conferiscono quell'aspetto vissuto che racconta il passaggio del tempo con il suo carico di ricordi e suggestioni.







WALL | PARETE  
 Terra Mista Lucidato  
 60x120 cm · 24"x48" #6 mm  
 Terra Mista Lucidato  
 120x120 cm · 48"x48" #6 mm  
 Terra Dolce Mat  
 60x120 cm · 24"x48" #6 mm  
 Terra Dolce Mat  
 120x120 cm · 48"x48" #6 mm

FLOOR | PAVIMENTO  
 Terra Dolce Mat  
 60x120 cm · 24"x48" #6 mm  
 Terra Dolce Mat  
 120x120 cm · 48"x48" #6 mm

WASHBASIN | LAVABO  
 Concrete Beige Mat  
 Gigacer Service #6 mm





WALL | PARETE  
 Terra Salina Mat  
 120x250 cm · 48"x100" #6 mm

FLOOR | PAVIMENTO  
 Terra Salina Mat  
 120x120 cm · 48"x48" #12 mm

SWIMMING POOL AREA | AREA PISCINA  
 Made 2.0 Dust Bocciardato R11  
 120x120 cm · 48"x48" #12 mm

WALL | PARETE  
 Terra Calma Mat  
 120x250 cm · 48"x100" #6 mm

FLOOR | PAVIMENTO  
 Terra Calma Mat  
 120x120 cm · 48"x48" #12 mm

OUTDOOR FLOOR | PAVIMENTO ESTERNO  
 Made 2.0 Rope Bocciardato R11  
 60x120 cm · 24"x48" #12 mm





# Terra

## COLOURS COLORI



Salina Calma Dolce Arsa

These pictures portray a portion of the slabs only.  
Le immagini rappresentate riproducono una porzione delle lastre.

## SURFACES SUPERFICI

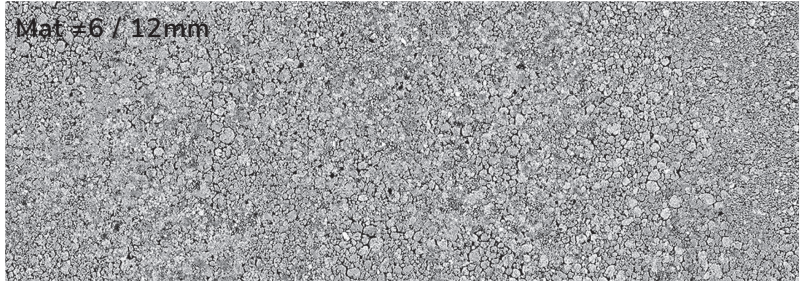

## SIZES AND THICKNESSES FORMATI E SPESSORI

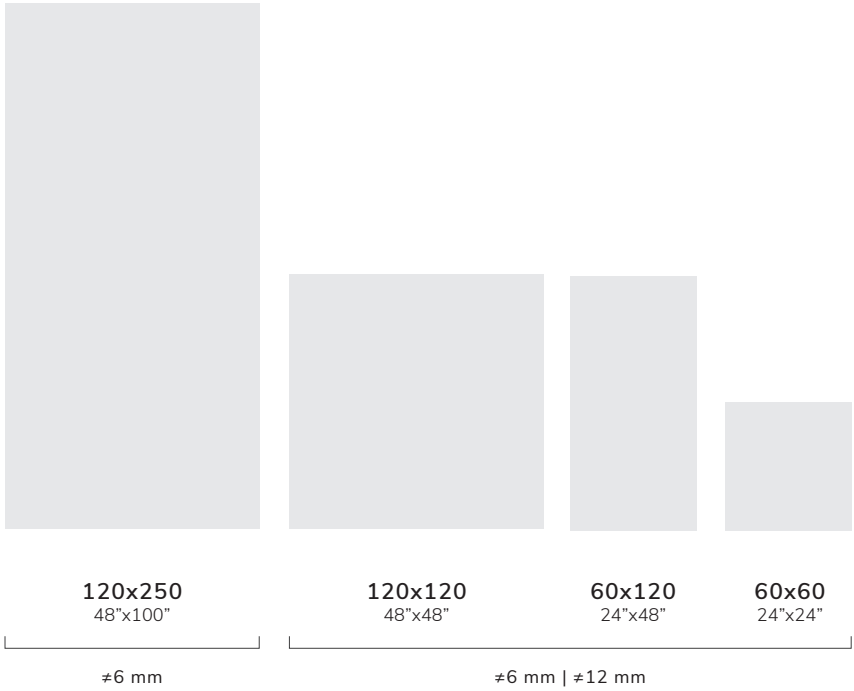

## DECOR DECORO



Mista

The picture portrays the whole 48"x100" / 120x250 cm slab.  
L'immagine rappresentata riproduce una lastra intera 120x250 cm / 48"x100".

Notes / Note:  
\*Terra Mista is not available in 24"x24" / 60x60 cm size.  
\*Terra Mista non è disponibile nel formato 60x60 cm / 24"x24".



# GIGACER / LCS Ceramics

144 / BETON  
152 / LCS 1  
160 / MOLITOR  
168 / POINTILLE



# LE CORBUSIER

{ Le Corbusier }

## Le Corbusier

LCS Ceramics

Based on Le Corbusier's  
Polychromie architecturale

A worldwide exclusive





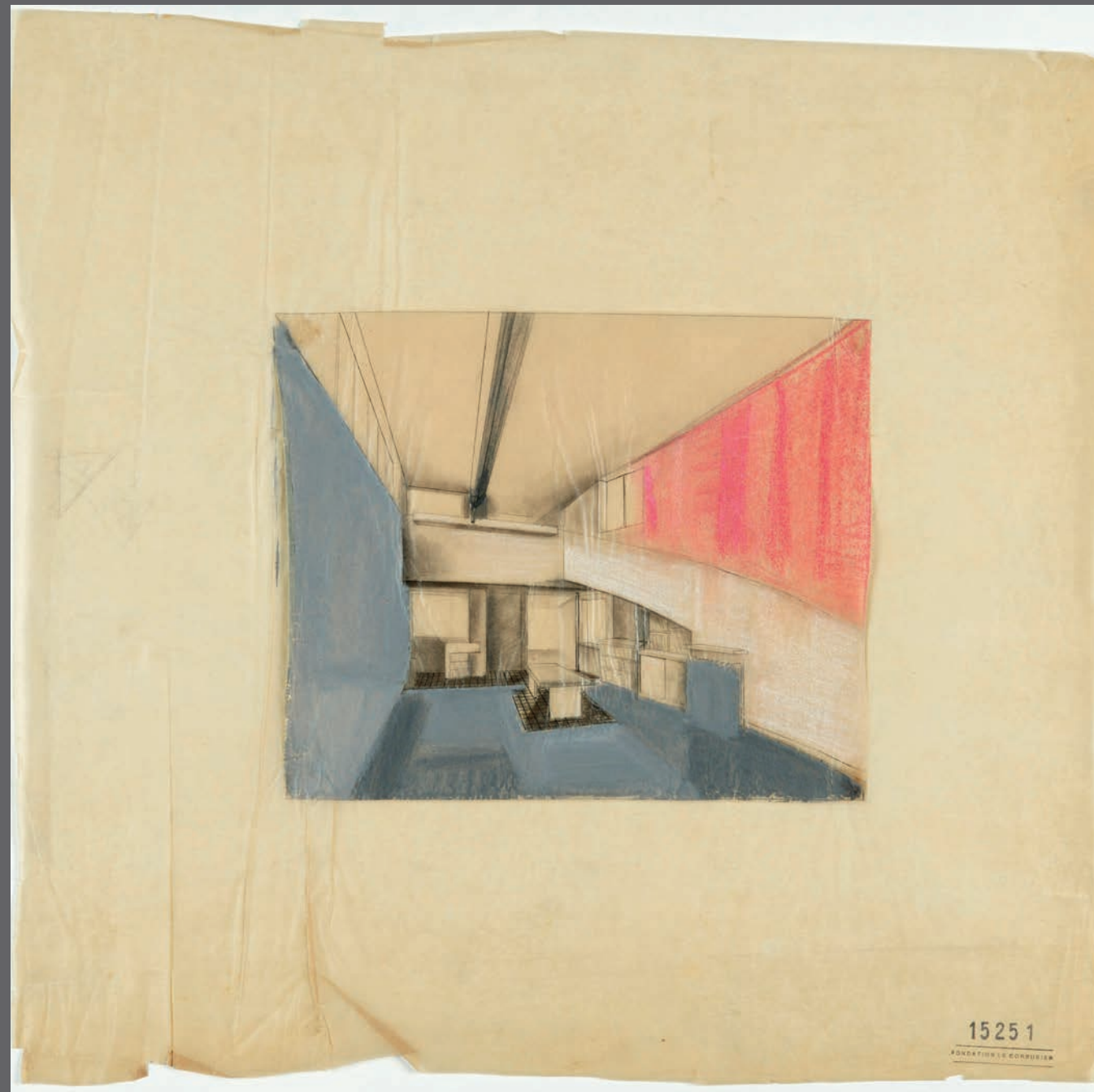

Pad 7 maison La Roche Paris 1923 - © LCS-ADAGP



Pad 7 maison La Roche Paris 1923 - © LCS-ADAGP

Les Couleurs Suisse AG of Zurich holds the exclusive international rights to Le Corbusier's unique "Polychromie architecturale" system and has granted Gigacer Spa the licence to use the original Les Couleurs® Le Corbusier colours in its collections LCS Ceramics, porcelain stoneware for architecture. LCS Ceramics is the first Gigacer colour system based on Le Corbusier's Architectural Polychromy. Innovative materials in porcelain stoneware for architecture.

Les Couleurs Suisse AG di Zurigo detiene i diritti in esclusiva mondiale sul sistema unico "Polychromie architecturale" di Le Corbusier e ha concesso a Gigacer Spa la licenza d'uso dei colori originali Les Couleurs® Le Corbusier sulle collezioni denominate LCS Ceramics, gres per l'architettura. LCS Ceramics è il primo sistema colore prodotto da Gigacer basato sulla Polychromie architecturale di Le Corbusier. Innovativi materiali in gres porcellanato ideati per pavimentare e rivestire l'architettura.



# LE CORBUSIER

{ *Le Corbusier* }

La-Chaux-des-Fonds / Roquebrune-Cap-Martin 1887 - 1965 ©

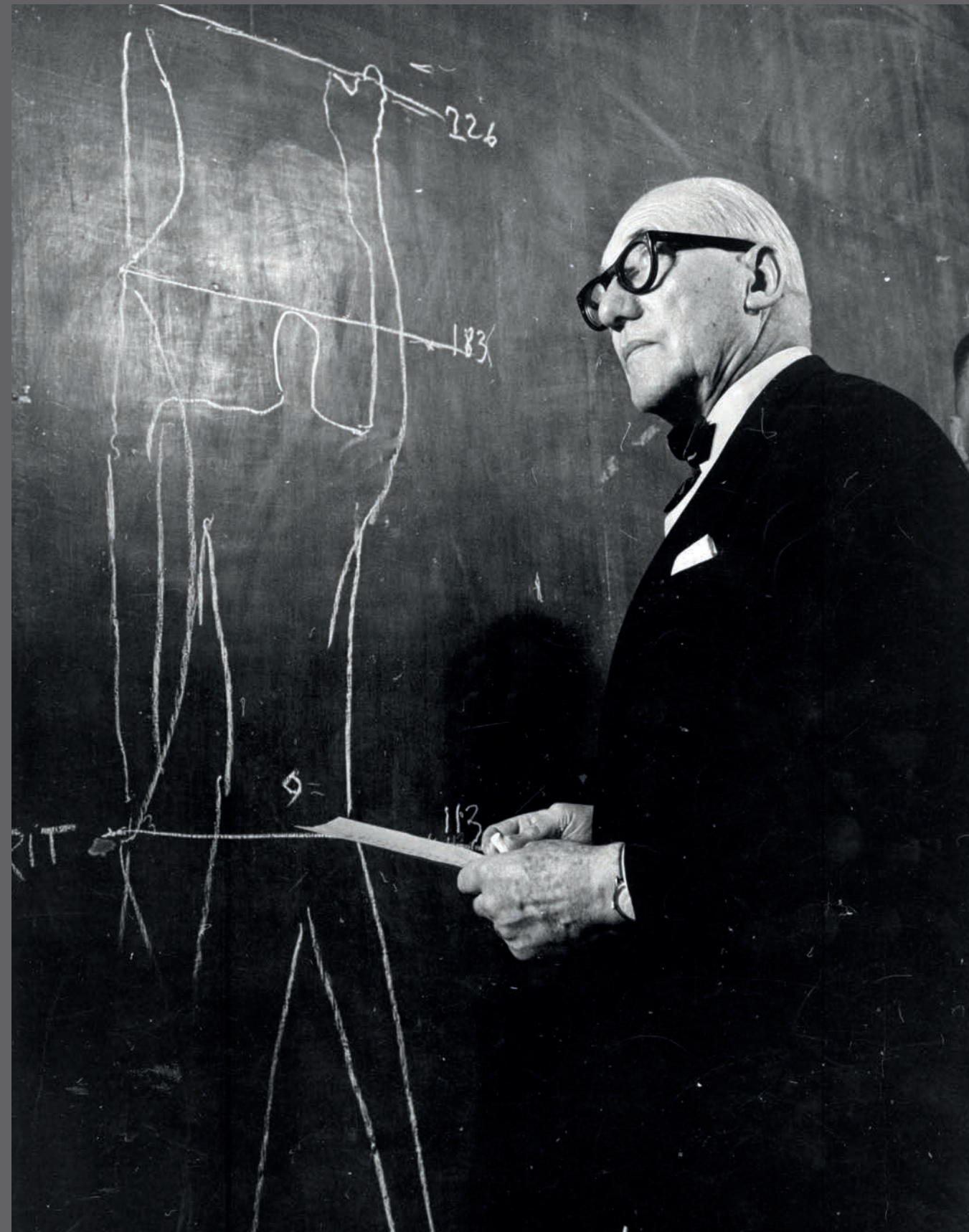

Charles-Edouard Jeanneret-Gris, better known by the pseudonym Le Corbusier (1887–1965), is considered the most important architect of the modern age. His works still have a considerable influence on architecture and design today. He designed many buildings and drew up numerous urban development plans throughout the world and today the majority of his architecture has been recognised by Unesco as World Heritage. Le Corbusier was an all-round artist, producing a large number of artworks such as paintings, sculptures, drawings and collages, enamels, tapestries, engravings and furniture, all with the same unmistakable design and which have become real icons. The colour schemes of his buildings and design objects were just as important to Le Corbusier as the ground plan and shape. Fascinated by the balanced colours he found in nature, Le Corbusier based his “Architectural Polychromy” on a structured and artistic choice of pigments.

Charles-Edouard Jeanneret-Gris, conosciuto con lo pseudonimo di Le Corbusier (1887-1965) è considerato il più importante architetto dell'era moderna. Ancora oggi le sue opere influenzano autorevolmente l'architettura e il design. Ha progettato moltissimi edifici e numerosi piani di sviluppo urbano in tutto il mondo, e oggi buona parte delle sue architetture sono state riconosciute dall'Unesco patrimonio dell'umanità. Le Corbusier ha lavorato in numerosi campi artistici dando vita ad una serie di opere quali dipinti, sculture, disegni e collage, smalti, arazzi, incisioni e oggetti d'arredo dal design inconfondibile, divenuti vere e proprie icone. Per Le Corbusier gli aspetti cromatici dei suoi edifici o dei suoi oggetti di design erano tanto importanti quanto la pianta e la forma. Affascinato dai colori equilibrati della natura, Le Corbusier diede vita alla “Polychromie architecturale” basandosi su una selezione progettuale e artistica di pigmenti.



# Béton

## Cement in architecture

Taking inspiration from the many buildings designed by Le Corbusier where he used exposed concrete, Gigacer has created Béton Gris and Béton Blanc, neutral ceramic porcelain surfaces which are reminiscent of the minimalist character of the famous Béton Brut. The range is ideal for wall and floor coverings for residential and public use and can be perfectly combined with the Le Corbusier LCS Ceramics colours.

## Il cemento in architettura

Traendo ispirazione dai molteplici edifici di Le Corbusier circa l'utilizzo del cemento a vista, Gigacer ha realizzato Béton Gris e Béton Blanc, superfici in grès ceramico dai toni neutri che riprendono il carattere minimalista insito nel famoso Béton Brut. La gamma è ideale per utilizzi a pavimento e rivestimento di ambienti sia residenziali che pubblici e trova una naturale abbinabilità con i colori LCS Ceramics Le Corbusier.





WALL | PARETE  
Béton Blanc  
120x250 cm · 48"x100" #6 mm

FLOOR | PAVIMENTO  
Molitor Gris Foncé 31 (32010)  
120x120 cm · 48"x48" #6 mm

STEP | GRADINO  
Béton Blanc  
Gigacer Service #6 mm







WALL | PARETE  
LCS 1 Noir d'Ivoire (4320E)  
30x120 cm · 12"x48" #6 mm  
Béton Gris  
120x250 cm · 48"x100" #6 mm

WALL | PARETE  
Béton Blanc  
120x250 cm · 48"x100" #6 mm





# Béton

## COLOURS

COLORI

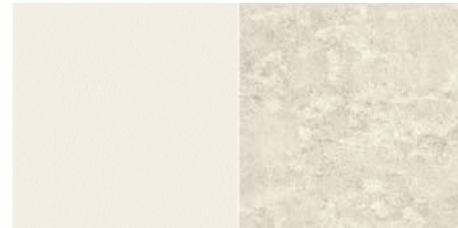

Blanc

Gris

## SIZES AND THICKNESSES

FORMATI E SPESSORI

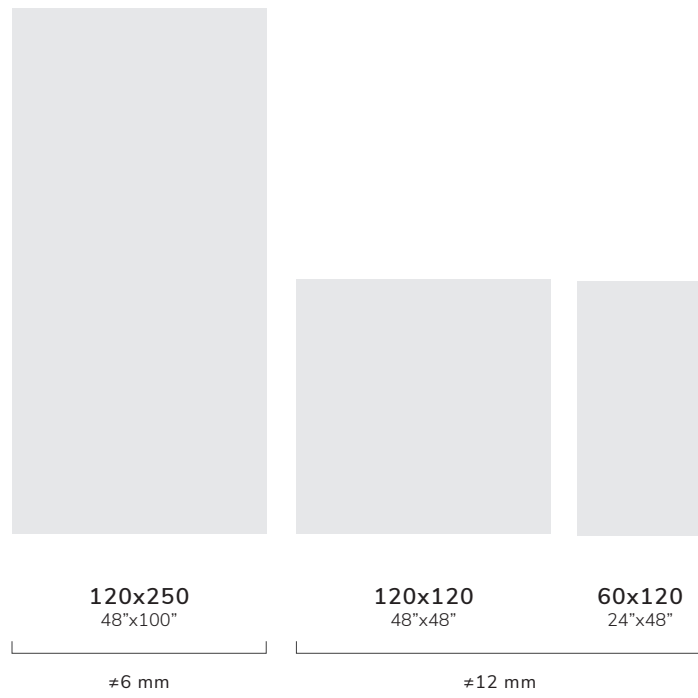

These pictures portray a portion of the slabs only.  
Le immagini rappresentate riproducono una porzione delle lastre.



## REFERENCE

RIFERIMENTO



Unite d'Habitation - Marseille - 1945 ©



# LCS 1 - glossy

Le Corbusier Ceramics

Glazed porcelain stoneware, glossy, brilliant. Ideal for indoor and outdoor wall coverings.

Le Corbusier Ceramics

Gres porcellanato smaltato, lucido, brillante. Ideale per utilizzi a rivestimento in ambienti sia interni che esterni.







WALL | PARETE  
Molitor Ombre Naturelle Claire (32142)  
120x250 cm · 48"x100" #6 mm  
LCS 1 Blanc (32001)  
30x120 cm · 12"x48" #6 mm

WALL | PARETE  
LCS 1 Céruléen Vif (32031) - Le Rubis (4320M)  
30x120 cm · 12"x48" #6 mm

FLOOR | PAVIMENTO  
Béton Blanc  
120x120 cm · 48"x48" #6 mm

SHOWER TRAY MODEL A | PIATTO DOCCIA MODELLO A  
Béton Blanc  
Gigacer Service #6 mm

WASHBASIN | LAVABO  
Béton Blanc  
Gigacer Service #6 mm





WALL | PARETE

Béton Blanc

120x250 cm · 48"x100" #6 mm

LCS 1 Terre Sienne Brique (32121)

30x120 cm · 12"x48" #6 mm

FLOOR | PAVIMENTO

Béton Gris

120x120 cm · 48"x48" #6 mm





# LCS 1 - glossy

## COLOURS

COLORI

These pictures portray a portion of the slabs only.  
Le immagini rappresentate riproducono una porzione delle lastre.



## SIZES AND THICKNESSES

FORMATI E SPESSORI



## REFERENCE

RIFERIMENTO



Maison des Jeunes et de la Culture - Firminy France - 1953 ©



# Molitor

## Immeuble Molitor

Immeuble Molitor is an apartment building designed by Le Corbusier and Pierre Jeanneret and built between 1931 and 1934. Located at the border between the city of Paris and the commune of Boulogne-Billancourt in France, it has been listed along with 16 other architectural works by Le Corbusier as a UNESCO World Heritage Site. The design was constrained by the narrow (12 m) and deep (24 m) configuration of the site and by strict zoning codes, which specified the parapet height, conformance to the existing street wall, and even the placement of the balconies and bow windows. Nevertheless, the architect's inventiveness is evident in the all-glass facades. Identical on both elevations, contemporary to Bernard Bijvoet's Maison de Verre, but Le Corbusier departed from glass-brick-only prototype by the addition of transparent openings. Externally the facades offer a contrast between solid glass bricks and transparent windows, but internally the apartments are flooded with light across the entire wall.

## Immeuble Molitor

Immeuble Molitor è un condominio progettato da Le Corbusier e Pierre Jeanneret e costruito tra il 1931 e il 1934. Situato al confine tra la città di Parigi e il comune di Boulogne-Billancourt in Francia, è stato elencato insieme ad altre 16 opere architettoniche di Le Corbusier come patrimonio mondiale dell'UNESCO. Il progetto era limitato dalla stretta (12 m) e profonda (24 m) configurazione del sito e da severi codici di zonizzazione, che specificavano l'altezza del parapetto, la conformità al muro stradale esistente e persino il posizionamento dei balconi e dei bovindi. Tuttavia, l'inventiva dell'architetto è evidente nelle facciate interamente in vetro. Identiche in entrambe le altezze, contemporanee alla Maison de Verre di Bernard Bijvoet, ma Le Corbusier partì dal prototipo di soli mattoni di vetrocimento con l'aggiunta di aperture trasparenti. Esternamente le facciate offrono un contrasto tra mattoni in vetro massiccio e finestre trasparenti, ma internamente gli appartamenti sono inondati di luce attraverso l'intera parete.





WALL | PARETE  
Pointillé Vert Anglais Pâle (32042)  
120x250 cm · 48"x100" #6 mm  
LCS 1 Blanc (32001)  
30x120 cm · 12"x48" #6 mm

FLOOR | PAVIMENTO  
Molitor Ombre Naturelle Claire (32142)  
120x120 cm · 48"x48" #12 mm







WALL | PARETE  
 Molitor Ombre Naturelle 31 (32140)  
 120x250 cm · 48"x100" #6 mm



WALL | PARETE  
 Molitor Ombre Naturelle Claire (32142)  
 120x250 cm · 48"x100" #6 mm  
 Molitor Ombre Naturelle Moyenne (32141)  
 Gigacer Service #6 mm  
 Molitor Ombre Naturelle 31 (32140)  
 120x250 cm · 48"x100" #6 mm

FLOOR | PAVIMENTO  
 Molitor Gris 31 (32011)  
 120x120 cm · 48"x48" #12 mm

SEAT | SEDUTA  
 Molitor Gris 31 (32011)  
 Gigacer Service #6 mm



# Molitor

## COLOURS

COLORI



Ombre Naturelle 31  
32140

Ombre Naturelle Moyenne  
32141

Ombre Naturelle Claire  
32142

Gris Clair 31  
32013

Gris 31  
32011

Gris foncé 31  
32010

These pictures portray a portion of the slabs only.  
Le immagini rappresentate riproducono una porzione delle lastre.

## SIZES AND THICKNESSES

FORMATI E SPESSORI

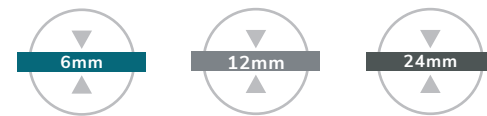
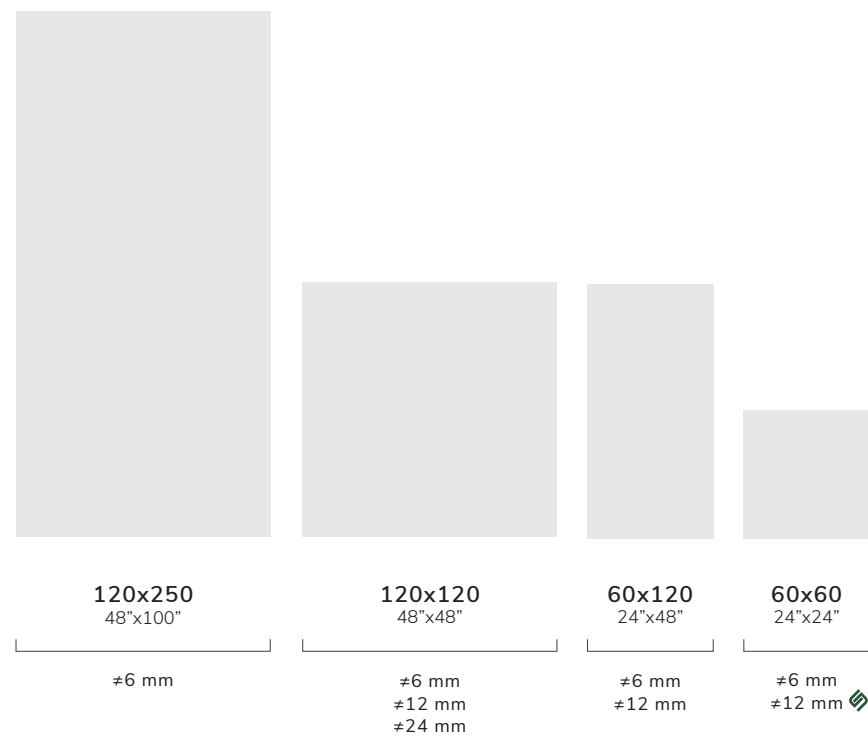

## SURFACES

SUPERFICI

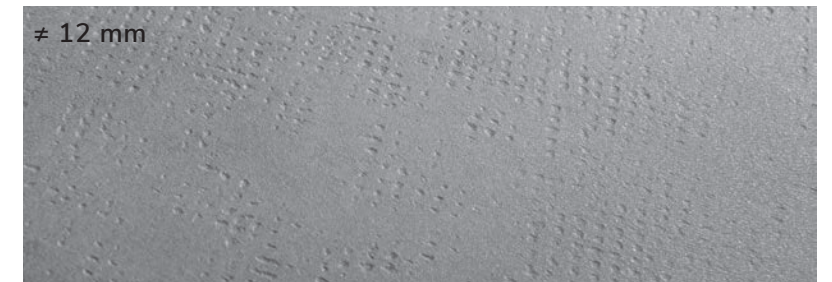
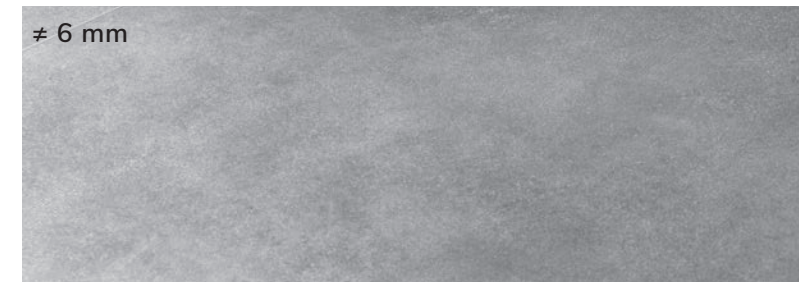

## REFERENCE

RIFERIMENTO



Immeuble Molitor - Paris - 1934 ©



# Pointillé

## Polychromie Architecturale

Pointillé is a reinterpretation of the wallpaper designed by Le Corbusier for the Swiss company Salubra, the same one that started the study of the Polychromie Architecturale. Pointillé is faithful to the spirit of the Master and uses contemporary technology to reproduce the surprising effect of the wall color sought by Le Corbusier. It was 1931 when Le Corbusier created the wall covering based on a basic and extemporaneous motif: the “dot”, later traced in oil on a solid colour base. This was made to prevent the effect of chromatic contrast fading away over time due to the effect of light. The combination of the colours is strictly taken from the Polychromie Architecturale.

## Polychromie Architecturale

Pointillé è una reinterpretazione della carta da parati progettata da Le Corbusier per l'azienda svizzera Salubra, la stessa che diede inizio allo studio della Polychromie Architecturale. Pointillé è fedele allo spirito del maestro e utilizza la tecnologia contemporanea per riprodurre l'effetto sorprendente del colore a parete ricercato da Le Corbusier. Era il 1931 quando Le Corbusier creò il rivestimento per pareti basato su un motivo basilico quanto estemporaneo: il “puntino” tracciato allora ad olio su una tinta unita, per evitare che l'effetto di contrasto cromatico svanisse nel tempo per effetto della luce. La combinazione dei colori è rigorosamente tratta dalla Polychromie Architecturale.





WALL | PARETE  
Pointillé Blanc Ivoire (4320B)  
120x250 cm · 48"x100" #6 mm  
Pointillé Vert Anglais Pâle (32042)  
Gigacer Service #6 mm

FLOOR | PAVIMENTO  
Béton Blanc  
120x120 cm · 48"x48" #12 mm







WALL | PARETE  
 Pointillé Vert Anglais Pâle (32042)  
 120x250 cm · 48"x100" #6 mm  
 Béton Blanc  
 120x250 cm · 48"x100" #6 mm

FLOOR | PAVIMENTO  
 Béton Blanc  
 120x120 cm · 48"x48" #12 mm

WALL | PARETE  
 Pointillé Blanc Ivoire (4320B)  
 120x250 cm · 48"x100" #6 mm  
 Molitor Ombre Naturelle 31 (32140)  
 120x250 cm · 48"x100" #6 mm

FLOOR | PAVIMENTO  
 Molitor Ombre Naturelle 31 (32140)  
 120x120 cm · 48"x48" #12 mm





# Pointillé

## COLOURS

COLORI



Blanc Ivoire  
4320B



Vert Anglais Pâle  
32042



Bleu Outremer 31  
32020

## SIZES AND THICKNESSES

FORMATI E SPESSORI

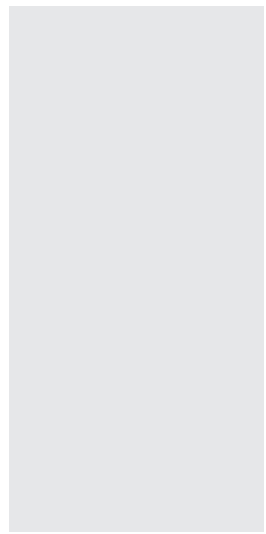

120x250  
48"x100"

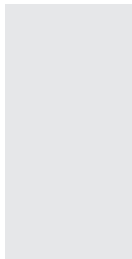

60x120  
24"x48"

±6 mm

These pictures portray a portion of the slabs only.  
Le immagini rappresentate riproducono una porzione delle lastre.



## REFERENCE

RIFERIMENTO

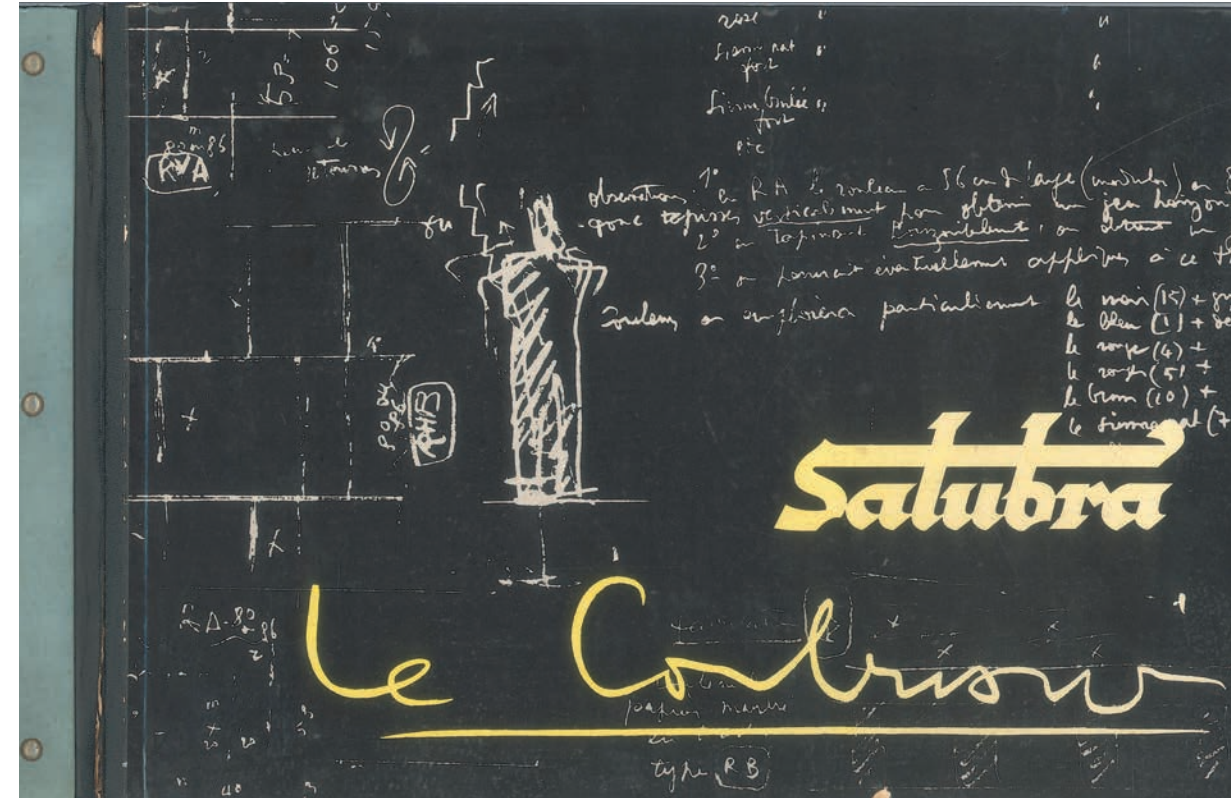

Immeuble Molitor - Paris - 1934 ©



# GIGACER / Gigacer Matchings





# GIGACER MATCHINGS

{ab·bi·na·men·ti}



Gigacer's style is one of a kind. That's why our products match so naturally!

There is a common theme running through the firm's range design which all its collections have in common. The focus of its style is always authenticity and originality, a contemporary feel and the quality characteristic of porcelain stoneware. Its style of choice is neutral, in natural colours with surfaces suitable to all home and public space uses and designed to be a stylish and practical backdrop to any lifestyle choice.

Gigacer offers a very wide range of formats, thicknesses, surfaces and colours for all types of space: floor and wall claddings, residential and commercial spaces, indoor and outdoor, furniture, ventilated facades and swimming pools. Gigacer Matchings is an invitation to personalise, a tool with which to transform living areas into our very own personal spaces.

PlayOne, a complex small size Gigacer range system, plays a fundamentally important part in Gigacer Matchings. It is the ultimate in form and colour matching. Its limited thickness means it can always be combined with large slabs, facilitating large-small size and continuous surface-decorative pattern combinations. This low thickness also makes Gigacer ideal for both floor and wall claddings with all horizontal and vertical spaces covered.

Gigacer ha uno stile unico, per questo il matching fra i nostri prodotti viene spontaneo!

Nel progetto di gamma dell'azienda corre un filo conduttore che unisce e accomuna le collezioni. La ricerca è sempre rivolta all'autenticità e all'originalità delle proposte, che mantengono un'impronta contemporanea e la qualità tipica del miglior gres porcellanato. Si predilige uno stile neutro, con colori naturali; superfici adeguate ai diversi utilizzi domestici e pubblici, pensate per essere lo sfondo elegante e pratico su cui si dipanano le forme dell'abitare.

Gigacer offre una gamma molto ampia di formati, spessori, superfici e colori per progettare ogni tipo di ambiente: pavimenti e rivestimenti, spazi residenziali e commerciali, indoor e outdoor, mobili, facciate ventilate e piscine. Gigacer Matchings è un invito alla personalizzazione, lo strumento per trasformare uno spazio abitativo nel nostro personale spazio.

PlayOne, un articolato sistema di piccoli formati della gamma Gigacer, gioca un ruolo fondamentale all'interno di Gigacer Matchings. È l'espressione massima degli abbinamenti tra forme e colori. Lo spessore sottile permette sempre l'abbinamento con la grande lastra, invitando alla combinazione del grande con il piccolo, della superficie continua con il pattern decorativo. Il basso spessore di Gigacer è ideale sia per i pavimenti che per i rivestimenti, includendo al suo interno tutte le superfici orizzontali e verticali.





**WALL | PARETE**  
 Gatsby Green Light  
 120x250 cm · 48"x100" #6 mm  
 Concrete Ice Mat  
 120x250 cm · 48"x100" #6 mm  
 Concrete Smoke Mat  
 120x250 cm · 48"x100" #6 mm

**FLOOR | PAVIMENTO**  
 Argilla Dry Material  
 120x120 cm · 48"x48" #6 mm

**WALL | PARETE**  
 Inclusioni Classico Rosso Mat  
 120x120 cm · 48"x48" #12 mm  
 Concrete White Mat  
 120x250 cm · 48"x100" #6 mm

**FLOOR | PAVIMENTO**  
 Inclusioni Classico Rosso Mat  
 120x120 cm · 48"x48" #12 mm

**WASHBASIN | LAVABO DOUBLE**  
 Inclusioni Classico Rosso Mat through body | tutta massa  
 50x180 cm · 19 1/2"x71"  
 Gigacer Service #12 mm





WALL | PARETE  
Elementa Warm Stone Mat  
120x250 cm · 48"x100" #6 mm  
Concept 1 Milk Mat  
Gigacer Service #6 mm

FLOOR | PAVIMENTO  
Elementa Warm Stone Mat  
120x120 cm · 48"x48" #6 mm







WALL | PARETE  
 Concept 1 Ink Flame Texture Mat  
 120x250 cm · 48"x100" #6 mm

WASHBASIN | LAVABO DOUBLE  
 Krea Orange  
 50x180 cm · 19 1/2"x71"  
 Gigacer Service #6 mm

WASHBASIN TOP | PIANO LAVABO  
 Concrete Graphite  
 Gigacer Service #6 mm

WALL | PARETE  
 Concept 1 Ink Flame Texture Mat  
 120x250 cm · 48"x100" #6 mm

FLOOR | PAVIMENTO  
 Concrete Graphite Mat  
 120x120 cm · 48"x48" #12 mm





WALL | PARETE  
Terra Mista Mat  
60x120 cm · 24"x48" #6 mm

FLOOR | PAVIMENTO  
Terra Arsa Mat  
120x120 cm · 48"x48" #6 mm  
Made 2.0 Mud Mat  
120x120 cm · 48"x48" #12 mm

OUTDOOR FLOOR | PAVIMENTO ESTERNO  
Made 2.0 Mud Bocciardato R11  
120x120 cm · 48"x48" #24 mm







**WALL | PARETE**  
 Krea Green  
 Small Hexagon 18x16 cm · 7"x6" #4.8 mm  
 Concrete Ice Mat  
 Small Hexagon 18x16 cm · 7"x6" #4.8 mm  
  
**KITCHEN TOP | TOP CUCINA**  
 Concrete Graphite Mat through body | tutta massa  
 Gigacer Service #12 mm

**WALL | PARETE**  
 Tele Foresta  
 60x120 cm · 24"x48" #4.8 mm

**FLOOR | PAVIMENTO**  
 Concrete Ice Mat  
 60x60 cm · 24"x24" #4.8 mm





WALL | PARETE  
Concrete Iron Mat  
120x250 cm · 48"x100" #6 mm

DESK | BANCONE  
Concrete Iron Mat  
Gigacer Service #6 mm

FLOOR | PAVIMENTO  
Inclusioni Soave Cenere Mat  
120x120 cm · 48"x48" #12 mm







**FLOOR | PAVIMENTO**  
Inclusioni Soave Vulcano Soft  
120x120 cm · 48"x48" #12 mm

**KITCHEN TOP | TOP CUCINA**  
Concept 1 Ink Levigato  
Gigacer Service #6 mm

**WALL | PARETE**  
Krea Ground - Orange  
Large Hexagon 36x31 cm · 14"x12" #4.8 mm

**WASHBASIN | LAVABO DOUBLE**  
Concrete Brown Mat  
Gigacer Service #4.8 mm





WALL | PARETE  
Light 250 Curtain - Piquet - Twill  
120x250 cm · 48"x100" #6 mm

Concrete Ice Mat  
Gigacer Service #6 mm

FLOOR | PAVIMENTO  
Light Gesso  
120x120 cm · 12"x12" #6 mm

KITCHEN TOP | PIANO CUCINA  
Concrete Mud Mat through body | tutta massa  
Gigacer Service #12 mm







WALL | PARETE  
 Light 250 Twill  
 120x250 cm · 48"x100" #6 mm  
 Concrete Ice Mat  
 Gigacer Service #6 mm  
 Gatsby Charleston  
 120x250 cm · 48"x100" #6 mm

WALL | PARETE  
 Argilla Marine - Biacca Material  
 Small Pentagon 17x10 cm · 7"x4" #6 mm

FLOOR | PAVIMENTO  
 Argilla Marine Quartz  
 60x60 cm · 24"x24" #12 mm

TOP | PIANO  
 Concrete White Mat through body | tutta massa  
 Gigacer Service #12 mm

CABINETS DOORS | ANTE  
 Concrete Graphite Mat  
 Gigacer Service #6 mm





WALL | PARETE  
Argilla Dark Material  
Mosaic 1.5x1.5 30x30 cm · 12"x12" #6 mm

FLOOR | PAVIMENTO  
Argilla Fog Material  
120x120 cm · 12"x12" #6 mm

COUNTER | BANCONE  
Concrete Graphite Mat through body | tutta massa  
Gigacer Service #12 mm



GIGACER /  
Gigacer matchings





COFFEE TABLE COUNTER TOP | PIANO DEL TAVOLINO  
Concept 1 Milk Texture Mat  
Gigacer Service #6 mm

FLOOR | PAVIMENTO  
Terra Dolce Mat  
120x120 cm · 48"x48" #12 mm

TABLE | TAVOLO  
Argilla Marine Material  
Gigacer Service #6 mm

FLOOR | PAVIMENTO  
Concrete Ice - Iron - Graphite Mat  
Diamond 18x31cm · 7"x12" #4.8 mm





# GIGACER / Technical notes



**208 / EDGES AND WORKTOP** | BORDI E TOP  
**210 / WASHBASINS** | LAVABI  
**211 / SHOWER TRAYS** | PIATTI DOCCIA  
**212 / GIGACER SERVICE** | GIGACER SERVICE  
**214 / SPECIAL TRIMS** | PEZZI SPECIALI  
**216 / INTENDED USE CLASSIFICATION** | DESTINAZIONI D'USO  
**217 / INSTALLATION SUGGESTION** | SUGGERIMENTI PER LA POSA  
**218 / OUTDOOR LAYING** | POSA PER L'ESTERNO  
**221 / THE ADVANTAGES OF 24MM** | I VANTAGGI DEL 24MM  
**222 / INSTALLATION AND ADHESIVES** | POSA E COLLA  
**224 / CLEANING AND MAINTENANCE** | PULIZIA E MANUTENZIONE  
**226 / CLEANING TIPS** | CONSIGLI PER LA PULIZIA  
**228 / SHADE VARIATION INDEX** | INDICE DI STONALIZZAZIONE  
**229 / CALIBRES** | CALIBRI  
**230 / PACKAGING** | IMBALLI  
**233 / TECHNICAL FEATURES** | CARATTERISTICHE TECNICHE  
**234 / COEFFICIENT OF FRICTION** | COEFFICIENTE DI ATTRITO  
**236 / CERTIFICATIONS** | CERTIFICAZIONI



Indoor

Outdoor







Gigacer offers the professional an unprecedented colour range that can be combined in multiple ways with the important system of shapes, thicknesses and surfaces designed for every use in architecture: residential and commercial spaces, flooring and cladding, through body worktops, stairs and special pieces, ventilated façades, vehicle accessible flooring and swimming pools & Spa.

Gigacer offre al professionista un'inedita gamma cromatica, che si abbina in modo trasversale all'importante sistema di formati, spessori e superfici pensati per ogni utilizzo in architettura: spazi residenziali e commerciali, pavimenti e rivestimenti, piani lavoro piena massa, scale e pezzi speciali, facciate ventilate, pavimenti carrabili, piscine & Spa.





## EDGES AND WORKTOP

BORDI E TOP

Our 12 mm through body slabs are particularly indicated for countertops, kitchen tops and vanity tops. The material is manufactured by using one single layer of precious powders that runs through the body of the tile from the top to the bottom. This allows then to process the material as if it was a natural stone, by rounding and refining the edges, but keeping all the pluses of the technical porcelain stoneware.

Le lastre in 12 mm di spessore tutta massa sono particolarmente indicate per il rivestimento di piani di lavoro, piani cucina, mobili da bagno. Il materiale viene prodotto utilizzando un solo strato di materiale prezioso, che attraversa la lastra fino al fondo, in modo che sia possibile lavorare i bordi come se fosse una pietra naturale, ma mantenendo tutte le caratteristiche migliorative del gres porcellanato tecnico non smaltato.

## COLOURS

COLORI



## DIMENSIONS

DIMENSIONI

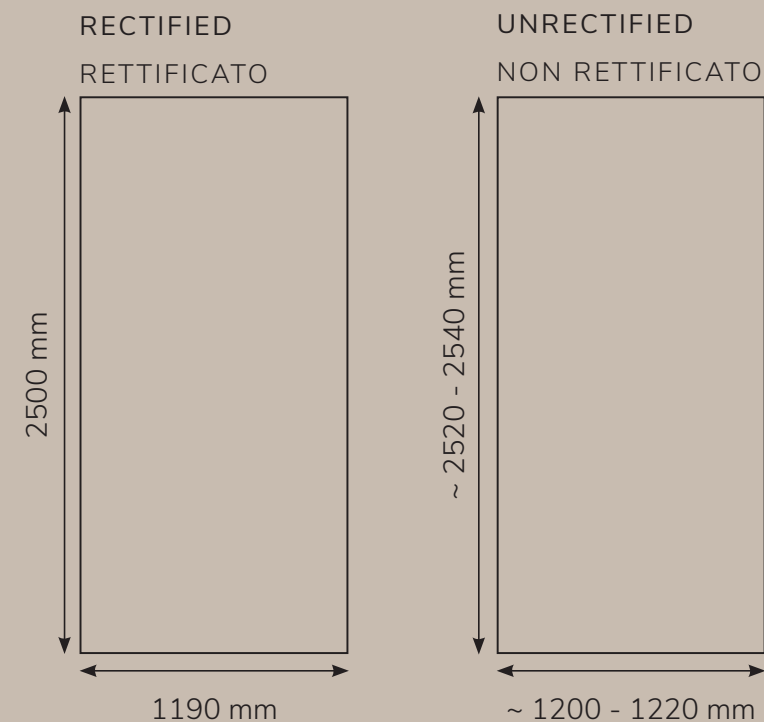

## EDGES MACHINING

LAVORAZIONI BORDI



A Costa a profilo inclinato  
Reverse angled ridge 45°

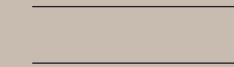

D Costa pari lati a vista  
Double straight squared ridge



B Costa pari a tondino  
Rounded straight ridge

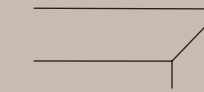

E Veletta a vista  
L-shaped squared ridge



C Costa a toro  
Full rounded ridge



F Taglio grezzo  
Raw edge

## WORKTOP MACHINING

LAVORAZIONI TOP

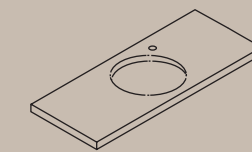

Foro grezzo circolare o sagomato  
Raw circular or shaped hole

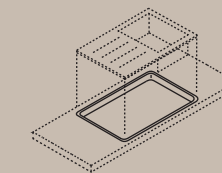

Foro filo top  
Top- aligned hole

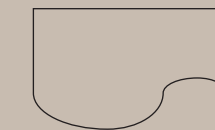

Sagomatura grezza  
Shaping raw

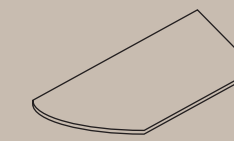

Terminale raggiato  
Radiused final

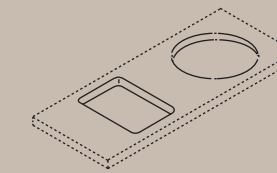

Foro satinato  
Satin hole

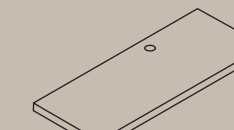

Foro per miscelatore  
Mixer hole

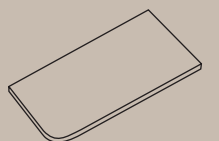

Angolo raggiato  
Radiused corner

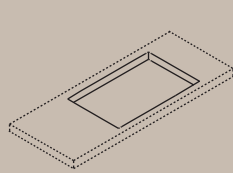

Foro grezzo rettangolare  
Raw rectangular hole





# WASHBASINS

LAVABI

## MIDDLE

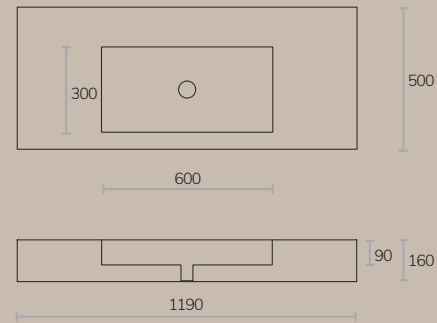

All colours in 4.8 e 6 mm thickness.  
Tutti i colori in 4.8 e 6 mm.

## RIGHT

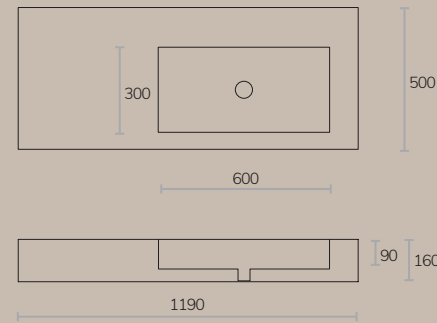

All colours in 4.8 e 6 mm thickness.  
Tutti i colori in 4.8 e 6 mm.

## LEFT

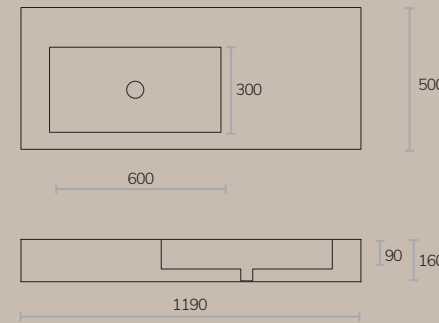

All colours in 4.8 e 6 mm thickness.  
Tutti i colori in 4.8 e 6 mm.

## DOUBLE

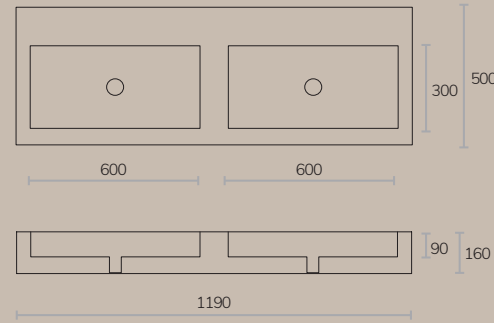

All colours in 6 mm thickness in 120x250 cm size.  
Tutti i colori in 6 mm nel formato 120x250 cm.

## OPTIONAL BASIN COVER COPERTURA VASCA OPZIONALE

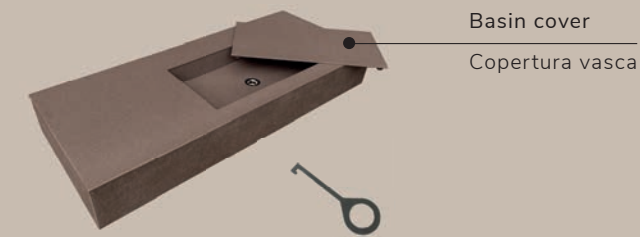

Notes / Note:  
Brackets, drain and siphon are includes.  
Staffe, piletta e sifone sono inclusi.  
All measurements are expressed in millimetres.  
Tutte le misure sono espresse in millimetri.

You can find all technical information about washbasins in our brochure "Gigacer Service".  
Tutte le informazioni tecniche inerenti ai lavabi le puoi trovare sulla brochure "Gigacer Service".

For inquiries concerning different thicknesses and sizes from the ones indicated in the table, please contact Gigacer Service.  
Per dimensioni o spessori diversi da quelli rappresentati in tabella contattare Gigacer Service.



# SHOWER TRAYS

PIATTI DOCCIA

## MODELLO A

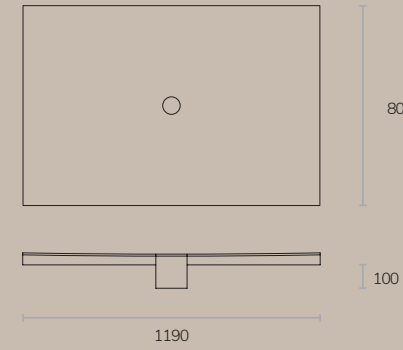

All colours in 4.8 e 6 mm thickness.  
Tutti i colori in 4.8 e 6 mm.

## MODELLO B

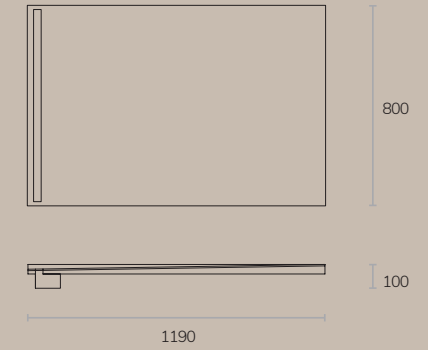

All colours in 4.8, 6 and 12 mm thicknesses.  
Tutti i colori in 4.8, 6 e 12 mm.



Notes / Note:  
Brackets, drain and siphon are includes.  
Staffe, piletta e sifone sono inclusi.  
All measurements are expressed in millimetres.  
Tutte le misure sono espresse in millimetri.

You can find all technical information about washbasins in our brochure "Gigacer Service".  
Tutte le informazioni tecniche inerenti ai lavabi le puoi trovare sulla brochure "Gigacer Service".

For inquiries concerning different thicknesses and sizes from the ones indicated in the table, please contact Gigacer Service.  
Per dimensioni o spessori diversi da quelli rappresentati in tabella contattare Gigacer Service.





# GIGACER SERVICE

GIGACER SERVICE



Gigacer Service is the firm's made to measure working service offered on all products. It enables slabs to be cut, perforated, polished and generally adapted to the individual project in line with the requisites of a specific client design. In this way the ceramic slabs can be used both to create decor elements and to personalise or adjust slab dimensions to flooring or decor designs. In this way the ceramic slabs can be matched with, or even identical to, the kitchen worktop, flights of steps, the bathroom worktop and even the basin in an infinity of possible forms and dimensions. Each single piece can be made in accordance with designers' instructions and technical drawings.

Gigacer Service è il servizio di lavorazioni su misura offerto da Gigacer su tutti i suoi prodotti. Consente di tagliare, forare, lucidare e in generale adattare le lastre al singolo progetto, seguendo le indicazioni di uno specifico disegno del cliente. In questo modo le lastre ceramiche possono essere utilizzate sia per realizzare elementi d'arredo, sia per personalizzare o adeguare al progetto le dimensioni di lastre per pavimento o rivestimento. Il pavimento o il rivestimento potrà così essere abbinato o addirittura identico al top cucina, ai gradini della scala, al top bagno o anche allo stesso lavabo, in una infinità possibilità di forme e dimensioni. Il pezzo unico viene realizzato anche seguendo le indicazioni e il disegno tecnico del progettista.





# SKIRTING

## BATTISCOPIA

Battiscopa 60  
#12mm

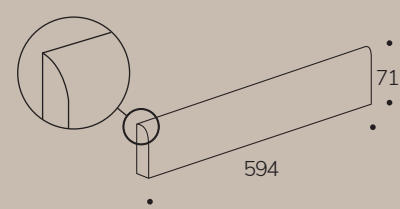

Battiscopa 120  
#4.8mm

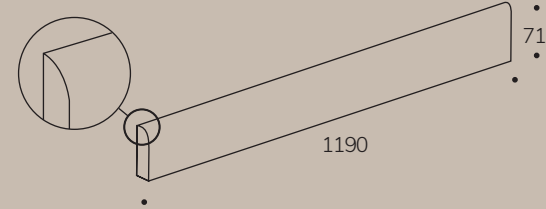

Battiscopa 120  
#6mm

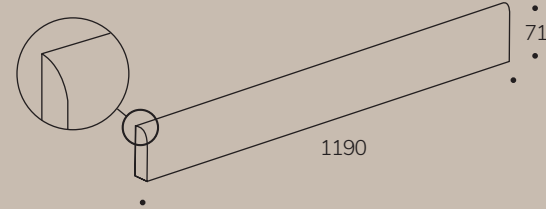

Use: finishing pieces that protect the lower part of the walls during everyday cleaning and maintenance operations.  
Details: the top of the 12mm thickness skirting pieces is cold glazed to hide the layers of the multilayer porcelain. 4.8, 6, 12mm skirtings are not glazed on the nose, as they are made of through body porcelain.

Utilizzo: pezzi di finitura che consentono di proteggere la parte bassa della parete durante le quotidiane operazioni di pulizia.  
Dettagli: la parte superiore del battiscopa 12mm viene arrotondata e smaltata a freddo per nascondere gli strati del multilayer. I battiscopa 4.8mm, 6mm e 12mm su materiale a piena massa, non necessitano di smaltatura.

# COSTA RETTA STEPTREADS

## GRADONI COSTA RETTA

Costa retta 60

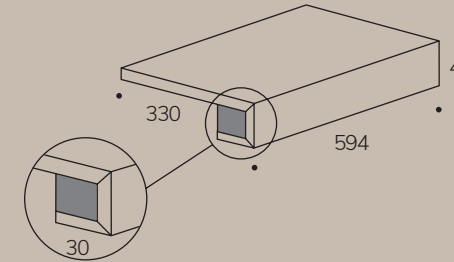

Costa retta 120

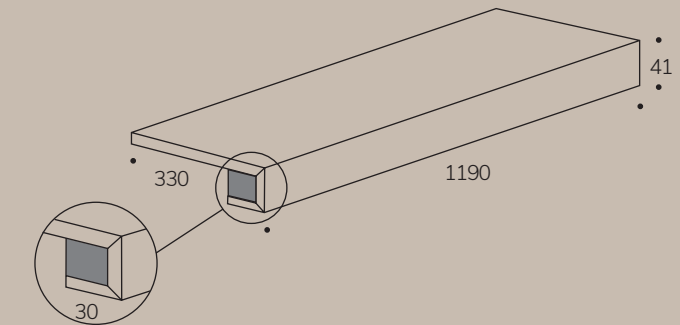

Use: steptreads for stairs, windowsills, terraces and balconies edge finish, poolside, indoor or outdoor.  
Utilizzo: gradini per scale, davanzali, finitura terrazze e balconi, bordo piscine, interno o esterno.

# VELA STEPTRADS

## GRADONI VELA

Vela 120

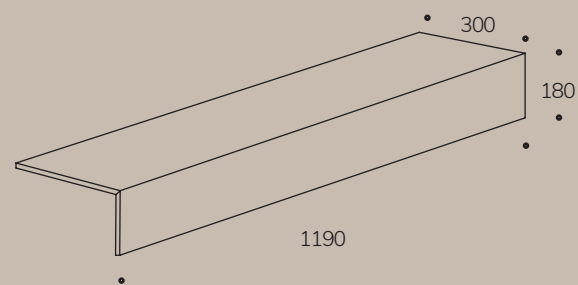

Use: steptreads for stairs.  
Utilizzo: gradini per scale.

# CHANGES ON REQUEST

## MODIFICHE SU RICHIESTA

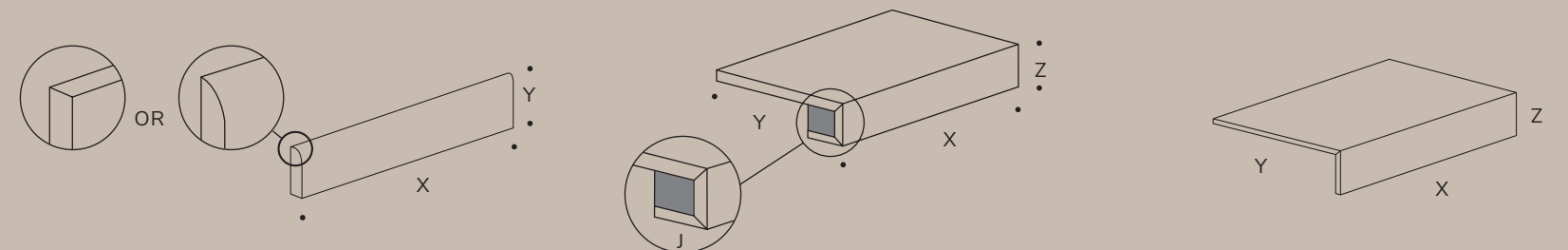

It is possible to require the feasibility and the quotation for the following changes:

- 1- squared top edge, instead of rounded.
- 2- unglazed top edge (on 12 mm thickness the multilayer will be visible).
- 3- bespoke sizes: please indicate X and Y in mm.

It is possible to request bespoke sizes on X, Y, Z and J and to ask for one or both sides closed, if the staircase is open.  
The piece can be made without nose, only at 90°. All sizes must be specified (X, Y and Z).

È possibile richiedere la fattibilità e la quotazione per le seguenti modifiche:

- 1- top squadrato invece che arrotondato.
- 2- top non smaltato (nel 12 mm sarà visibile il multilayer).
- 3- misure non standard: indicare misura X e Y in mm.

Le misure X, Y, Z e J sono modificabili a piacimento.

È possibile richiedere il gradone con chiusura su un lato o su entrambi, nel caso la scala sia aperta.

Il pezzo può essere realizzato anche a vela senza rientranza, è necessario indicare tutte le misure richieste (X, Y e Z).



# INTENDED USE CLASSIFICATION

DESTINAZIONI D'USO

	New floors	Floor renovation	Wall covering	Light commercial	Heavy commercial	Outdoor	Raised floor	Countertops Kitchentops
	Pavimenti nuove costruzioni	Pavimenti in ristrutturazioni	Rivestimenti	Commerciale leggero	Commerciale pesante	Esterno	Sopraelevato	Piani di lavoro
4.8 mm 6 mm	+	++	++	+	--	-	--	-
12 mm multilayer	++	+	+	++	++	+	+	-
12 mm through body	-	-	-	-	-	-	-	++
20 mm 24 mm	-	-	-	-	++	++	++	-
	Floor tiling on screed in new buildings	Floor tiling on screed or on existing floor (in ceramic or natural stone) in buildings under renovation	Wall covering	Indoor public places subject to medium pedestrian traffic	Indoor public places subject to heavy pedestrian traffic	Outdoor places	Raised floor with floating structure or PVC supports	
	Posa a terra in nuove costruzioni su massetto	Posa a terra su pavimenti esistenti, in ceramica o pietra naturale, o su massetto in costruzioni in stato di ristrutturazione	Rivestimento muri	Ambienti pubblici interni a medio traffico	Ambienti pubblici interni ad alto traffico	Ambienti esterni	Pavimenti sopraelevati con struttura flottante o posa su supporti in PVC	

- ++ Recommended | Consigliato
- + Suitable | Appropriato
- Not recommended | Non consigliato
- Not suitable | Non appropriato

# INSTALLATION SUGGESTIONS

SUGGERIMENTI PER LA POSA

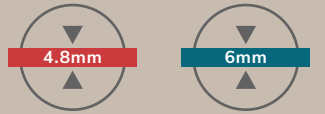

4.8 mm and 6 mm slabs are resistant, thin, lightweight, easy to handle and cut, fire-resistant, frostproof, environmentally friendly and require no special care for maintenance. 4.8 mm / 6 mm is an ideal product for cladding. 4.8 mm / 6 mm slabs are particularly suitable in the case of renovation of residential floors and walls: they can be laid on the existing floor, allowing for a dramatic demolition and disposal cost savings. GIGACER 4.8 mm is suitable for indoor and outdoor wall covering and it is particularly indicated in all cases where it is preferable not to load too much weight on the building's structure. 4.8mm/6mm can be combined with the 12 mm slabs of every collection because it has the same caliber and it is perfectly modular with 2 mm joints. 4.8 mm / 6 mm is a green product: it allows savings in terms of energy consumption, raw materials, packaging and transport. It is a valid alternative to the traditional 12 mm in all those cases where lightness and less thickness represent a determinant variable.

4.8 mm and 6 mm tiles can be fixed together on the same surface, as the real difference in thickness is minimal.

## Installation suggestions

GLUING: Double spreading (on substrate and on the back of the tile).

CUTTING: Standard dry diamond clipper for porcelain tiles, bench machines with diamond disks.

DRILLING: Drills with porcelain drill tips, hollow mills or hose-mounted drill bits (for large size holes), hydrojet.

Never use the hammer function when drilling.

Le lastre di 4.8 mm e 6 mm sono: resistenti, sottili, leggere, facili da movimentare e da tagliare, resistenti al fuoco, ingelive, ecocompatibili e non necessitano di particolari accorgimenti per la manutenzione.

È un prodotto ideale per pavimenti e rivestimenti ed è particolarmente adatto nel caso di ristrutturazione di pavimentazioni e rivestimenti residenziali: si applica sull'esistente senza opere di demolizione e relativi costi di smaltimento.

Il nostro porcellanato sottile è abbinabile ai pavimenti della stessa collezione in spessore tradizionale, dei quali mantiene non solo le stesse caratteristiche estetiche, ma anche il medesimo calibro e modularità. Il 4.8 mm / 6 mm è un prodotto dal design ecologico: lo spessore ridotto comporta un minor impatto ambientale in termini di consumo di energia, materie prime, imballo e trasporti. Costituisce una valida alternativa al gres porcellanato di spessore tradizionale in tutti i casi in cui il minor spessore e la leggerezza costituiscono un fattore determinante.

In fase di posa, le lastre di spessore 4.8 mm e 6 mm risultano perfettamente complanari.

## Suggerimenti per la posa

Incollaggio: Doppia spalmatura (sul fondo e sul retro della piastrella)

TAGLIO: Normale taglierina da cantiere, sega a dischi diamantati.

FORATURA: trapani a punta per gres porcellanato, frese a tazza, idrogetto.

Non usare il percussore e raffreddare con acqua nel punto di contatto.



# OUTDOORD LAYING

POSA PER ESTERNO

20 mm / 24 mm system and the special antislip R11 A+B+C surface guarantee high technical performances as well as remarkable safety for outdoor use. 20 mm system is frostproof, inabsorbent, easy to clean, has very high resistance to impact, abrasion and to chemical aggressions.

Il sistema del 20 mm / 24 mm e la speciale superficie antiscivolo R11 A+B+C garantiscono elevate prestazioni tecniche e notevole sicurezza per l'uso all'aperto. Il sistema del 20 mm è ingelivo, inassorbente, facile da pulire, ha un'altissima resistenza agli urti, all'abrasione e alle aggressioni chimiche.

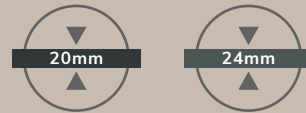

Antislip R11 A + B + C

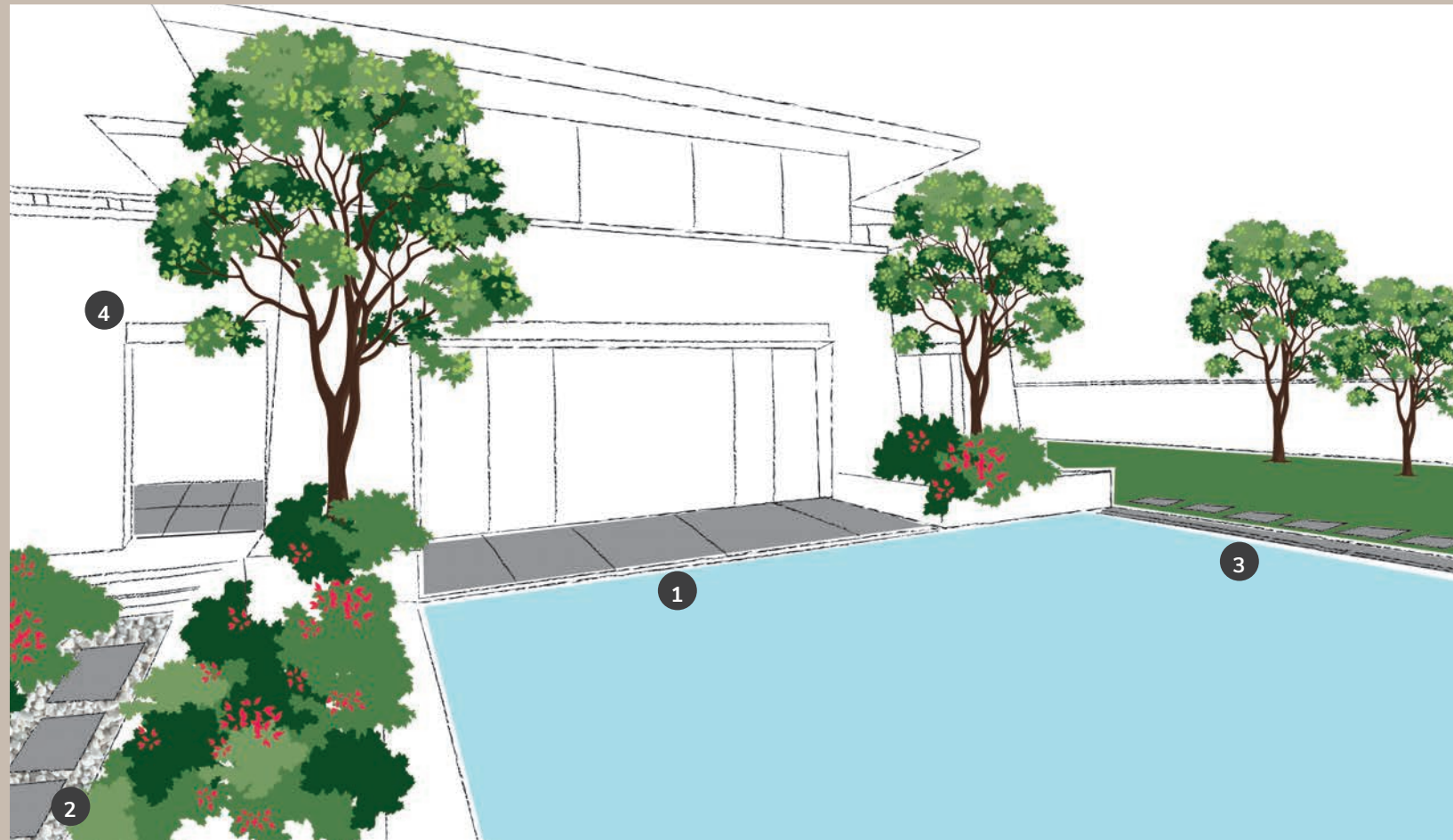

- 1** Laying on glue  
Posa a colla tradizionale

- 2** Dry installation on gravel  
Posa a secco su ghiaia



- 3** Dry installation on grass  
Posa a secco su erba



- 4** Polypropylene supports  
Pavimento sopraelevato

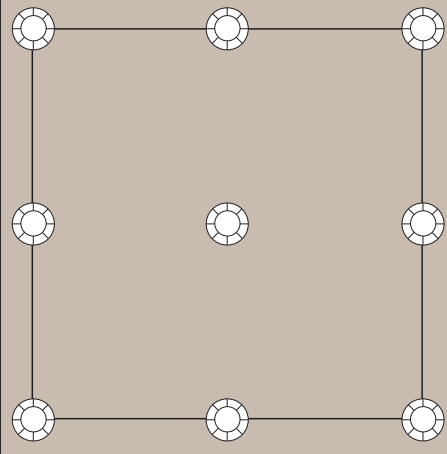
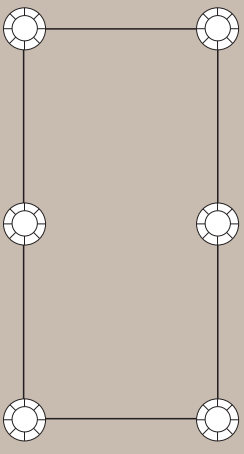
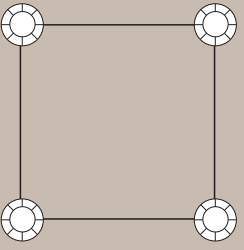

# POLYPROPYLENE SUPPORTS

PIEDINI IN POLIPROPILENE

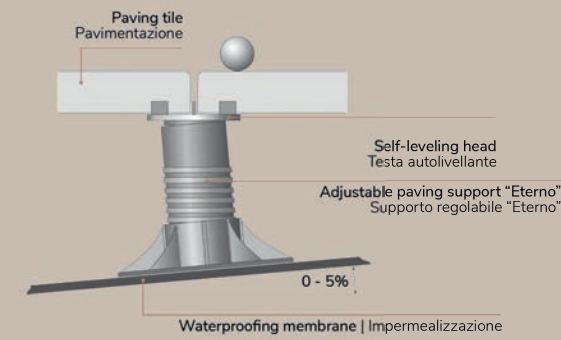
120x120 · 48"x48" 9 pcs/slab 9 pz/lastra	60x120 · 24"x48" 6 pcs/slab 6 pz/lastra	60x60 · 24"x24" 4 pcs/slab 4 pz/lastra
		



Notes / Note:  
All measurements are expressed in millimetres.  
Tutte le misure sono espresse in millimetri.

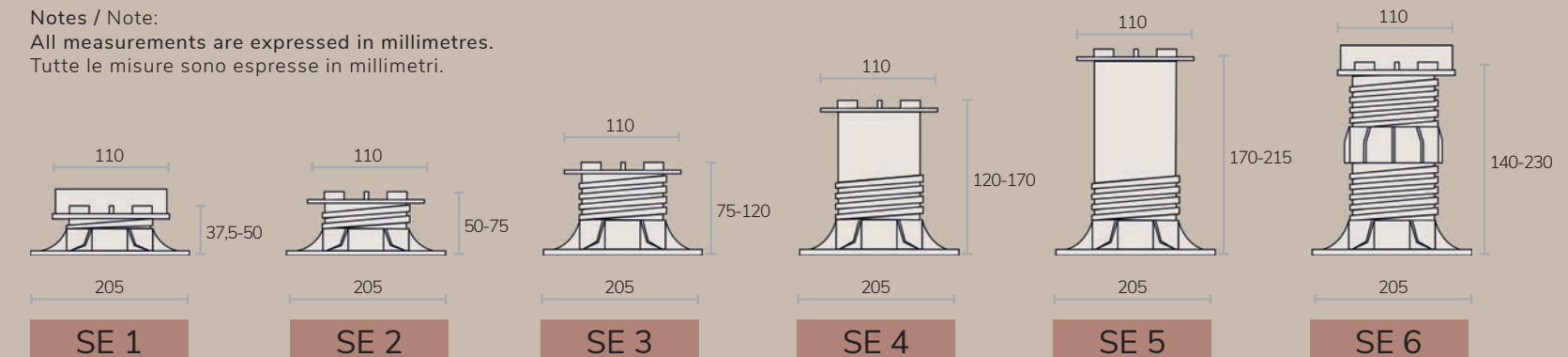



# OUTDOOR SPECIAL TRIMS

PEZZI SPECIALI PER L'ESTERNO



# THE ADVANTAGES OF 24MM

I VANTAGGI DEL 24MM



Bullnose  
Gradino costa toro

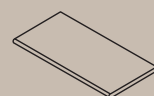

30x60  
12"x24"

Grid  
Griglia

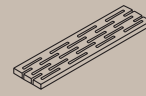

15x60  
6"x24"

Angle grid  
Griglia ad angolo

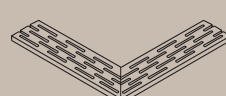

15x60  
6"x24"

Internal corner  
Angolo interno



30x60  
12"x24"

Outside corner  
Angolo esterno



30x60  
12"x24"

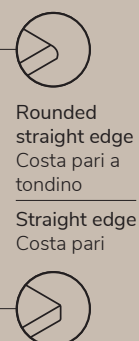

The strength of 2 12 mm thick tiles glued together with a special glue grants a breaking strength of  $\geq 20000 \text{ N}^{**}$ .  $\neq 24 \text{ mm}$  is frostresistant, has a very high breakage load, it is resistant to salts, easy to clean also using pressure washers, resistant to the attack of mould, moss and verdigris treatments, removable, reusable, anti-slip, fire-resistant and very easy to install.  $\neq 24 \text{ mm}$  does not change and lasts over time in any climatic conditions, characteristics that are a must for outdoor floor coverings. Installation can be done using different techniques, according to the kind of surface. The porcelain stoneware slabs can be laid using a dry installation system, directly onto gravel or sand substrates as well as with raised installation (i.e. Eterno ivica Pedestals) or glued. Raised installation is made with a support structure made of polypropylene, prefabricated, load-bearing modules, which can be fix, adjustable and self levelling. They have a minimum height of 37,5 mm and a Maximum height of 230 mm. Raised installation allows for easy inspection of underlying cabling and circuits without the need for burdensome work.  $\neq 24 \text{ mm}$  raised floor is the best solution for residential and commercial destinations such as balconies, paths, access floors, etc., Protecting the under-space and easily allowing any kind of technical intervention. A 4 mm joint is requested for water drainage.

- ✓ Possibility to have a product with the same tone and surface for indoor and the outdoor spaces
- ✓ Big format 120x120 24 mm thickness
- ✓ Possibility to have an antislip material for the outdoor with easy lay
- ✓ Efficient drainage
- ✓ Dry laying
- ✓ Endurance and strength
- ✓ Cleanability
- ✓ Frost reistance

The grout in the 24 mm thickness has the same colour of the tiles. Some examples using 24 mm: raised access floors / open terrances / closed terraces / walkways / swimming pools / gardens / shower trays.

La resistenza di 2 lastre di 12 mm di spessore, incollate assieme con colla speciale garantisce uno sforzo di rottura di  $\geq 20000 \text{ N}^{**}$ .  $\neq 24 \text{ mm}$  è resistente al gelo, ha un altissimo carico di rottura, è resistente ai sali, facile da pulire anche utilizzando idropulitrici, resistente agli attacchi di muffe, funghi, muschi e trattamenti al verderame. È rimovibile, riutilizzabile, antiscivolo, resistente al fuoco e facile da installare.  $\neq 24 \text{ mm}$  non cambia col tempo e resiste a tutte le condizioni climatiche, caratteristiche fondamentali per un pavimento esterno. La posa può essere fatta utilizzando diverse tecniche, secondo il tipo di superficie da ricoprire. Le lastre possono essere installate a secco direttamente su ghiaia, sabbia o altri substrati, possono essere stese su supporti sopraelevati (es. Eterno Ivica Pedestal) o incollate. L'installazione sopraelevata può essere effettuata con una struttura portante di moduli in polipropilene, che possono essere fissi, regolabili e autolivellanti. Hanno una altezza minima di 37,5 mm e massima di 230 mm. L'installazione sopraelevata consente una facile ispezione di cavi o condutture senza dover rompere il pavimento.  $\neq 24 \text{ mm}$  pavimento sopraelevato è la migliore soluzione per luoghi residenziali o commerciali come balconi, vialetti, ecc. dal momento che protegge la superficie sottostante e consente ogni tipo di intervento tecnico. Consigliamo una fuga di 4 mm per lo scolo dell'acqua.

- ✓ Possibilità di avere un prodotto con lo stesso tono e superficie posato nelle aree interne ed esterne
- ✓ Grande formato 120x120 in 24 mm di spessore
- ✓ Possibilità di avere un pavimento antiscivolo all'esterno con posa facilitata
- ✓ Drenaggio efficace
- ✓ Posa a secco
- ✓ Durata e resistenza
- ✓ Pulibilità
- ✓ Ingegneria

Lo stucco del bordo del 24 mm è colorato in tinta con il fondo scelto. Esempi di utilizzo del 24 mm: pavimento sopraelevati / terrazzi all'aperto / terrazze chiuse / vialetti esterni / facciate ventilate / spiagge piscine / piatti doccia.



# INSTALLATION AND ADHESIVES

## POSA E COLLA

### THE SUBSTRATE

The floor substrate must be resistant enough to bear the expected stress and weight added with the ceramic tiles, it must be perfectly planar, perfectly aged (aged 28 days or according to the manufacturer's specifications) and dry, and free of any lose part such as oil, water, dust, paint, grease etc., which might compromise the adhesion of the slabs.

### REINFORCED CONCRETE SUBSTRATE

The substrate must be aged, cured, clean, dry and free of any substance which might compromise the adhesion of the ceramic. Any crack due to hygrometric shrinkage must be sealed using a two-component epoxy fluid adhesive (ie. EPORIP by Mapei or similar). If the concrete support is dirty or has surface dust it must be thoroughly cleaned and the a suitable single-component resin primer with a very low content of colatile organic compounds (VOC) must be applied (ie. PRIMER G or ECO PRIM T by Mapei spa or similar). If the concrete surface has any surface inconsistencies it must be consolidated with a suitable single-component or two-component epoxy or polyurethane primer (such as PRIMER MF or ECOPRIM PU 1K by Mapei spa or similar).

### SCREED COATS

The screed surface must be aged (aged 28 days or according to the manufacturer's specifications), cured, clean, dry and free of any substance which might compromise the adhesion of the ceramic. Any crack due to hygrometric shrinkage must be sealed using a two-component epoxy fluid adhesive (ie. EPORIP by Mapei or similar). Once the surface is completely cured it is important to check that it is strong enough to bear the weight of the ceramic that will be fixed on it. If the concrete support is dirty or has surface dust it must be thoroughly cleaned and the a suitable single-component resin primer with a very low content of colatile organic compounds (VOC) must be applied (ie. PRIMER G or ECO PRIM T by Mapei spa or similar). If the concrete surface has any surface inconsistencies it must be consolidated with a suitable single-component or two-component epoxy or polyurethane primer (such as PRIMER MF or ECOPRIM PU 1K by Mapei spa or similar). For floor heating installations the correct switch on cycle of the system must be performed in compliance with the applicable standards and the indications of the manufacturer of the floor heating system.

### EXISTING CERAMICS OR STONE FLOORINGS

For ceramic and stone floorings, check that the existing covering is perfectly attached to the support, planar and free of any cracks or sections that tend to detach from the substrate. If not proceed as follows:

- seal the floor cracks with two-component fluid epoxy resins (such as EPORIP by Mapei spa or similar);
- fill any gaps created when removing any tiles or slabs that do not adhere, using rapid setting thixotropic smoothing compounds (such as ADESILEX P4 or NIVORAPID by Mapei spa or similar);
- correct any planarity imperfections with levelling mortars, after cleaning the existing surface and, if necessary, using a suitable primer (such as ECO PRIM T by Mapei spa or similar ).

Generally speaking existing ceramic or stone floorings must be suitably cleaned with a solution of warm water and caustic soda at 20%, and rinsed thoroughly to remove any trace of loose substances. In specific cases the surface can be subjected to some surface abrasion to achieve a rough and clean support, in order to improve the subsequent adhesion.

### TILES INSTALLATION

Before laying Gigacer slabs select the most suitable adhesive according to the type of support, the final environment, the weather conditions of the site and the time available between laying and use. The table below lists a few examples of adhesive systems suitable for laying our slabs on horizontal indoor surfaces.

### SUGGESTED ADHESIVES

Ardex - Mapei - Kerakoll

For a perfect installation and a complete wetting we suggest to apply the adhesive with double spreading, applying the glue both on the substrate and on the back of the tile. We suggest to use this procedure especially for 4,8 mm and 6 mm slabs.

Apply the adhesive with an adequately sized notched trowel, firstly laying one thin layer on the support with the flat edge of the trowel and then applying the desired thickness with the notched edge. Then apply the adhesive on the substrate with a notched trowel and lay the tile. Beat the tile with a rubber hammer to ensure perfect wetting and remove any air bubble which might have generated between the tile and the substrate. It is possible to use systems such as Tuscan Leveling or similar to help maintaining the perfect planarity of the floor.

### GROUTING

We suggest to use 2 mm joints in case of multi-format flooring and 2-4 mm in case of single-format. Please read carefully our technical specifications charts and apply the necessary dilatation joints. The joints must be grouted only after the adhesive has hardened, normally 3 hours for fast set adhesives and at least 24 hours for regular set adhesives. These values refer to laying carried out at +23°C and 50 % relative humidity.

### IL SUPPORTO

Il massetto o il substrato deve essere sufficientemente resistente a sopportare il peso aggiuntivo previsto con l'installazione del pavimento in ceramica, deve essere perfettamente planare, perfettamente maturo (da 28 giorni di presa o secondo indicazioni del produttore del cemento) e libero da qualsiasi detrito o liquido sulla superficie (polvere, sabbia, terra, olio, vernice, grasso, ecc.) che possa compromettere l'adesione della ceramica al supporto.

### SUPPORTI IN CEMENTO RINFORZATO

Il supporto deve essere maturo, pulito, asciutto e libero da qualsiasi sostanza che possa compromettere l'adesione della ceramica al substrato. Ogni crepa formatasi a seguito del restringimento idrometrico del supporto deve essere sigillata con adesivo bicomponente epossidico (es. EPORIP di Mapei spa o simili). Se il supporto presenta tracce di polvere o sporco deve essere pulito accuratamente e successivamente deve essere applicato uno strato di primer in resina monocomponente con contenuto di componenti organici volatili (VOC) molto basso (es. PRIMER G o ECO PRIM T di Mapei spa o simili). Se la superficie del cemento presenta parti scrostate o indebolite è necessario consolidarle con un primer epossidico o in poliuretano mono o bicomponente (come PRIMER MF o ECOPRIM PU 1K di Mapei spa o simili).

### MASSETTI

Il massetto deve essere maturo (28 giorni di presa o secondo indicazioni del produttore del cemento), pulito, asciutto e libero da qualsiasi sostanza che possa compromettere l'adesione della ceramica al substrato. Ogni crepa formatasi a seguito del restringimento idrometrico del supporto deve essere sigillata con adesivo bicomponente epossidico (es. EPORIP di Mapei spa o simili). Una volta che la superficie è completamente liscia e matura è necessario controllare che abbia la resistenza necessaria a sopportare le sollecitazioni e il peso ai quali sarà sottoposta con la posa della ceramica. Se il supporto presenta tracce di polvere o sporco deve essere pulito accuratamente e successivamente deve essere applicato uno strato di primer in resina monocomponente con contenuto di componenti organici volatili (VOC) molto basso (es. PRIMER G o ECO PRIM T di Mapei spa o simili). Se la superficie del cemento presenta parti scrostate o indebolite è necessario consolidarle con un primer epossidico o in poliuretano mono o bicomponente (come PRIMER MF o ECOPRIM PU 1K di Mapei spa o simili). Per pavimenti riscaldati deve essere eseguito il corretto ciclo del sistema in conformità con le norme vigenti e le indicazioni del produttore del sistema di riscaldamento a pavimento.

### PAVIMENTI ESISTENTI IN CERAMICA, COTTO O PIETRA

Per il fissaggio delle lastre su pavimenti esistenti controllare per prima cosa che il pavimento esistente sia ancora solidamente attaccato al substrato, che sia planare e non siano presenti rotture o parti distaccate. Se queste condizioni non sono interamente soddisfatte procedere come segue:

- Sigillare le crepe e le rotture con una resina epossidica bicomponente (come EPORIP di Mapei spa o simili)
- Riempire i vuoti lasciati da eventuali pietre o piastrelle rimosse usando un prodotto livellante (come ADESILEX P4 o NIVORAPID di Mapei spa o simili)
- Correggere ogni imperfezione di planarità con malte livellanti dopo aver pulito la superficie e aver usato, se necessario, un primer (come ECO PRIM T di Mapei o simili).

In generale i pavimenti esistenti in ceramica o pietra naturale devono essere accuratamente puliti con una soluzione di acqua tiepida e soda caustica al 20%, e sciacquati abbondantemente per rimuovere ogni traccia di sostanza. In alcuni casi la superficie può essere sottoposta ad abrasione, per ottenere un supporto più ruvido e aumentare l'aderenza delle colle.

### LA POSA

Prima di installare le lastre Gigacer occorre selezionare l'adesivo più adatto a seconda del tipo di supporto, delle condizioni climatiche e del tempo che intercorrerà tra la posa e l'inizio dell'utilizzo della superficie calpestabile. La tabella seguente illustra alcuni esempi di adesivi adatti alla posa delle lastre Gigacer, sia di 12 mm che di 4,8 mm di spessore.

### ADESIVI CONSIGLIATI

Ardex - Mapei -Kerakoll

Per una posa perfetta e una completa bagnatura consigliamo, soprattutto in caso di utilizzo delle lastre sottili in 4,8 mm e 6 mm, di effettuare la doppia spalmatura, applicando la colla sia sul retro della lastra che sul supporto. Applicare prima uno strato sottile di colla sul retro della lastra con una spatola liscia, e di seguito applicare altro adesivo stendendolo con una spatola dentata effettuando movimenti semicircolari. Applicare poi la colla sul sottofondo con una spatola dentata e posare la lastra. Battere la lastra con un martello di gomma per assicurarsi della perfetta bagnatura e scongiurare la presenza di vuoti d'aria. È possibile utilizzare sistemi per agevolare la perfetta planarità della posa, soprattutto con lastre di grande formato, come ad esempio il Tuscan Leveling System.

### STUCCATURA

Consigliamo una fuga di 2 mm in caso di posa multiformato e 2-4 mm in caso di posa di un formato unico. È necessario consultare le nostre tabelle di caratteristiche tecniche e applicare i giunti di dilatazione necessari. Lo stucco deve essere applicato solo dopo che l'adesivo si sia indurito, normalmente dopo 3 ore in caso di adesivo rapido e dopo 24 ore in caso di adesivo standard. Questi valori si riferiscono ad una posa all'asciutto effettuata a una temperatura di +23°C e con il 50% di umidità relativa.



# CLEANING AND MAINTENANCE

PULIZIA E MANUTENZIONE

SURFACES CLEANING	ARGILLA QUARTZ CONCEPT 1 LEVIGATO CONCRETE SIGNS CONCRETE SOFT ELEMENTA SOFT INCLUSIONI CLASSICO LEVIGATO INCLUSIONI SOAVE SOFT MADE 2.0 LEVIGATO TERRA LUCIDATO	ARGILLA MATERIAL CONCEPT 1 MAT / BOCCIARDATO / TEXTURE CONCRETE MAT ELEMENTA MAT / BOCCIARDATO GATSBY INCLUSIONI CLASSICO MAT INCLUSIONI SOAVE MAT / BOCCIARDATO KREA LIGHT LIGHT 250 MADE 2.0 MAT / BOCCIARDATO QUARRY MAT / BOCCIARDATO TERRA MAT LE CORBUSIER LCS CERAMICS
Initial cleaning Pulizia dopo posa	Deterdek Pro ÈCOSÌ Cherodal	Deterdek Pro È COSÌ Cherodal
Surface protection Protezione superficiale	Fila MP90	/
Daily maintenance Pulizia ordinaria	Cleaner Pro ÈCOSÌ Velvet	Cleaner Pro ÈCOSÌ Velvet
Extraordinary cleaning Pulizia straordinaria	PS87 Pro / SR95 ÈCOSÌ Mic One	PS87 Pro / SR95 ÈCOSÌ Mic One
TYPE OF SPOTS   TIPO DI SPORCO		DETERGENT   DETERGENTE
Animal and vegetable grease, ice cream, fruit juices, tea, vegetable stains Grassi animali e vegetali, gelato, succhi di frutta, the, macchie di verdura	Detergente a base alcalina: PS87 Pro	
Wine, beer, vinegar, coffee, inks, markers, nicotine, urine, vomit, coca cola, hair dye Vino, birra, aceto, caffè, inchiostri, pennarelli, nicotina, urina, vomito, coca cola, tintura per capelli	Detergente a base alcalina: PS87 Pro o smacchiante SR95 o ÈCOSÌ Mic One	
Limescale, rust, mortar, metallic marks, anti-abrasion protective wax deposits Depositi efflorescenze calcare, ruggine, malte, segni metallici, cera protettiva antiabrasione	Detergente a base acida: Deterdek Pro o ÈCOSÌ Cherodal	
Resins, bitumen, candle waxes, tar, scotch residues Resine, bitume, cere di candele, catrame, residui di scotch	Solvente SOLV	
Vernice, graffiti Paint, graffiti	Detergente a base alcalina: PS87 Pro o sverniciante FILA NO PAINT STAR	

# INTENSIVE MAINTENANCE

PULIZIA STRAORDINARIA

TYPE OF SPOTS TIPO DI MACCHIA	ECOSI	FILA	SOLVENTS SOLVENTI	ACIDS ACIDI	ALKALI ALCALI
Beer Birra	Mic One	PS87 Pro			•
Coffee Caffè	Mic One	PS87 Pro			•
Limescale marks Calcare	Cherodal	Deterdek Pro		•	
Tar Catrame	Mic One	PS87 Pro	•		
Cement Cemento	Cherodal	Deterdek Pro		•	
Candle wax Cera di candela	Hot water + peat Acqua calda + terra	Hot water + peat Acqua calda + terra	•		•
Cola Coca Cola	Mic One	PS87 Pro		•	•
Glue Colla	Cherodal	Deterdek Pro	•		
Ice-cream Gelato	Mic One	PS87 Pro			•
Chewing gum Gomma da masticare	Dry ice Ghiaccio secco	Dry ice Ghiaccio secco	•		•
Tyre rubber Gomma di pneumatico	Mic One	PS87 Pro	•		•
Ink Inchiostro	Mic One	PS87 Pro	•		•
Nicotine Nicotina	Mic One	PS87 Pro			•
Marker Pennarello	Mic One	PS87 Pro	•		•
Resin Resine	Mic One	PS87 Pro	•		
Rust Ruggine	Cherodal	Deterdek Pro		•	
Nail-polish Smalto per unghie	Mic One	PS87 Pro	•		
Blood Sangue	Mic One	PS87 Pro			•
Cigarette Sigaretta	Mic One	PS87 Pro		•	
Wall painting Verince murale	Cherodal	Deterdek Pro		•	
Wine Vino	Mic One	PS87 Pro			•
Oil Olio	Mic One	PS87 Pro			•
Grease Grasso	Mic One	PS87 Pro			•



# CLEANING TIPS

## CONSIGLI PER LA PULIZIA

GIGACER products are constantly controlled and undergo all kind of stain resistance tests recommended by UNI EN. The surface of a perfectly vitrified tile is made by a material similar to glass and it must be treated like glass when it must be cleaned.



### INITIAL CLEANING

The first cleaning after installation is the most important in the whole life of the floor. It is made to remove any residue of grout, glue or cement, that if are left on the surface of the slabs might compromise the stain resistance properties of the ceramic floor. Never use mechanic machines for initial cleaning: grout and glue residues removal is a chemical process.

TYPE OF GROUT	WHEN IT MUST BE CLEANED	WHAT TO USE	HOW TO CLEAN IT
Cementitious grout mixed with water	After 2/3 days and within 7 days from grouting	Acide detergent - Deterdek Pro or ECOSì Cherodal	Follow the instructions provided by the producer of the cleaning solution. Previously test the detergent on a tile that hasn't been installed or on a hidden part of the floor before using the detergent on the whole surface, in particular on honed or polished floors. The surface must be moistened with water before washing. Leave the solution on the floor for some minutes, always following the instructions of the cleaning solution producer. Then collect the liquids and rinse thoroughly with water. Absorb the water with a rug or a vacuum machine until all the residues have been removed. Repeat rinsing operations if needed, until all residues will have been removed.
Epoxy or bicomponent grouts	Immediately	Follow the instructions of the grout producer	Cleaning must be done immediately and very carefully, because this kind of grouts harden very quickly. Strictly follow the instructions provided by the grout producer and previously verify their effectiveness on a loose tile before proceeding with grouting operations on the whole area. Check carefully that all grout residues have been removed by observing the surface backlight.

Cleaning bush-hammered surfaces is more demanding. We suggest to proceed immediately and to use brushes that can reach even the most difficult area.

If the initial cleaning has not been carried out correctly it is possible to see residues or stains on the floor, especially along the joint spacings. In these cases it is necessary to repeat the initial cleaning operation, using the cleaning solutions in higher concentrations and leaving them longer on the floor. It is very difficult to remove grout once it's dry. Please contact the grout producer in case of problems.

### DAILY MAINTENANCE

For daily maintenance we suggest to remove dust with a microfiber cloth, then wash the surface with a neutral detergent with low residue, like VELVET E'COSI' or Cleaner Pro diluted in water as indicated by the producer (about 3 spoons in a 5 litres of water) using a wet cloth. The cloth must be washed very often in the water and detergent solution. It is crucial that the solution used is neutral, without wax, acids, solvents or abrasive particles. Using dirt water, polishing products or too much detergent can form an invisible layer on the surface of the slabs, causing stains and allowing the floor to retain dust. Never use stain removers, anti rust or spray because they often contain hydrofluoric acid that would damage the floor irreparably.

We suggest to waterproof the grouted joints with FILA's FUGAPROOF, that prevents water absorption by the joints, makes it easier to remove dirt and keeps joints clean for a long time.

If daily maintenance is not carried out correctly it is possible to see opaque halos on the surface of the tiles, that the floor looks more glossy than it should or that footprints remain after walking. In these cases we suggest to apply a neat detergent such as Cleaner Pro and leave it for 5-10 minutes. Then rub with a cloth or a rug. Rinse thoroughly with water and collect the liquids with a rug or with a vacuum machine. Dry with a microfiber cloth.

Gigacer will never be held responsible for changes that might occur to the surface of the floor if it is cleaned with mechanical procedures and not with the products and procedures indicated in this guide.

I prodotti GIGACER vengono sottoposti continuamente a tutti i test di resistenza alle macchie previsti dalle norme UNI EN. La superficie di una piastrella completamente greificata è composta da materiale simile al vetro e come tale va trattata in fase di pulizia.



### PULIZIA INIZIALE

La prima pulizia dopo la posa è la più importante nella intera vita del pavimento. Serve a rimuovere qualsiasi residuo di stucco, colla, cemento, calce o boiaccia, che se lasciati sulla superficie delle lastre possono minare definitivamente le caratteristiche di pulibilità del pavimento in ceramica. Non utilizzare mai strumenti meccanici per la prima pulizia: la rimozione dei residui di stucco e colla è un procedimento chimico.

STUCCO UTILIZZATO	QUANDO FARE LA PULIZIA	COSA USARE	MODALITA' D'USO
Stucco cementizio miscelato con acqua	Dopo 2/3 giorni ed entro 7 giorni dalla stuccatura	Detergente a base acida - Deterdek Pro o ECOSì Cherodal	Seguire le istruzioni fornite dal produttore del detergente. Testare preventivamente il detergente su una piastrella non posata o in posizione nascosta prima dell'uso, in particolare su prodotti lappati, lucidati o levigati. Le superfici da pulire devono essere inumidite con acqua prima del lavaggio. Lasciare agire il prodotto per alcuni minuti, sempre seguendo le istruzioni del produttore. A fine lavaggio raccogliere il liquido dal pavimento e sciacquare abbondantemente con acqua. Raccogliere l'acqua di risciacquo con aspiraliquidi o strofinaccio. Ripetere l'operazione di risciacquo fino a che tutti i residui acidi non sono stati rimossi.
Stucco epossidico, bi-componente e reattivo	Immediatamente	Seguire le indicazioni del produttore dello stucco	La pulizia deve essere eseguita subito ed accuratamente, dal momento che questo tipo di stucchi indurisce molto rapidamente, anche nel giro di pochi minuti. Seguire tassativamente le modalità di pulizia indicate dal fabbricante dello stucco e verificarne l'efficacia con una prova preliminare di pulizia prima di procedere alla stuccatura dell'intera superficie piastrellata. Verificare bene che tutto lo stucco venga debitamente rimosso anche osservando la superficie controluce.

La pulizia delle superfici bocciardate è più laboriosa. Consigliamo di procedere rapidamente e di utilizzare spazzole che possano raggiungere anche le aree più difficili.

Se la pulizia iniziale non è stata fatta correttamente è possibile che si notino sul pavimento residui, patine lucide o aloni localizzati in particolare attorno alle fughe. In questi casi è necessario ripetere l'operazione di pulizia iniziale dopo posa, eventualmente utilizzando i detersivi in concentrazioni maggiori e lasciandoli agire più a lungo. Gli stucchi, una volta asciugati, sono di difficilissima rimozione, a volte impossibile. Contattare il produttore dello stucco.

### Pulizia QUOTIDIANA

Per la pulizia quotidiana è sufficiente asportare la polvere con un panno in microfibra, lavare la superficie con il detergente neutro a basso residuo VELVET E'COSI' o Cleaner Pro diluiti in acqua come indicato dal produttore (circa una tazzina in un secchio da 5 litri d'acqua) utilizzando uno straccio umido che andrà sciacquato spesso nella soluzione. E' essenziale utilizzare un detergente neutro privo di cere, acidi, solventi o componenti abrasive. L'uso di acqua sporca o prodotti lucidanti o un eccesso di detersivi può, col tempo, formare una patina invisibile sulla superficie delle lastre, causa di aloni e macchie. Non utilizzare mai smacchiatori tipo antiruggine o di tipo spray perché spesso contengono acido fluoridrico, che danneggerebbe irreparabilmente il pavimento.

E' bene impermeabilizzare le fughe con il protettivo per fughe tipo FUGAPROOF della FILA, il quale impedisce l'assorbimento di macchie, facilita la rimozione dello sporco e mantiene la fuga come nuova per lungo tempo.

Se la pulizia quotidiana non viene effettuata correttamente è possibile che appaiano aloni opachi, che il pavimento risulti più lucido di quanto non dovrebbe o che rimangano impronte al passaggio. In questi casi e' bene applicare un detergente tipo Cleaner Pro non diluito e lasciare agire per 5-10 minuti. Quindi frizionare con un tampone o uno straccio. Risciacquare abbondantemente e raccogliere i liquidi con uno straccio o una macchina aspiraliquidi. Asciugare infine con un panno in microfibra.

Gigacer non sarà mai responsabile per alterazioni superficiali che possano avvenire sul pavimento se questo viene pulito con procedimenti meccanici e non con i prodotti e i procedimenti indicati in questa guida.



## SHADE VARIATION INDEX

INDICE DI STONALIZZAZIONE

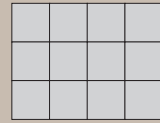

### V1 - LOW

Monochromatic product.  
Prodotto monocromatico.



### V2 - MODERATE

Prodotto con leggera variazione cromatica.  
Product with light chromatic variation.

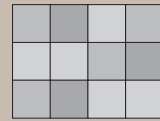

### V3 - HIGH

Prodotto con marcata variazione cromatica.  
Product with high chromatic variation.

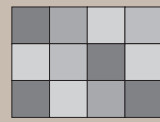

### V4 - VERY HIGH

Prodotto con forte variazione cromatica.  
Product with very high chromatic variation.

Collection Collezione	Index Indice
Argilla	V2
Argilla Pentagon   PlayOne	V3
Concept 1 Mat   Levigato   Texture   Bocciardato	V2
Concept 1 Texture Platinum   Red   Flame   Turquoise	V3
Concept 1 PlayOne	V3
Concrete	V1
Concrete PlayOne	V2
Concrete / Made 2.0 Blend	V4
Elementa   All sizes	V3
Gatsby	V2
Inclusioni Classico / Soave	V3
Krea	V3
Krea PlayOne	V4
Light	V2
Light 250	V2
Made 2.0	V1
Quarry	V3
Tele	V3
Terra	V3
LCS1	V1
Béton gris 120x250	V2
Béton gris 60x120   120x120	V3
Béton blanc   All sizes	V1
Molitor 120x250   120x120	V2
Molitor 60x120	V3
Pontillé 120x250	V2
Pontillé other sizes	V4

## CALIBRES

CALIBRI

Our slabs are always rectified and the table below indicates their final size in millimetres.

Our standard caliber is 09 and all sizes with the same caliber, when multiples, are modular with 2 mm joint spacing.

Le nostre lastre sono sempre rettificate e hanno dimensioni finali in millimetri come da tabella.

Il calibro standard è lo 09 e i formati dello stesso calibro multipli tra loro sono modulari con 2 mm di fuga.

Nominal size (cm) Formato nominale (cm)	Rectified size (mm) Formato rettificato (mm)	Caliber Calibro
120x250	1190x2500	09
120x120	1190x1190	09
60x120	594x1190	09
30x120	296x1190	09
60x60	594x594	09
30x60	296x594	09
30x30	296x296	09
15x60	147x594	09
10x60	97x594	09
5x60	47x594	09
20x20	197x197	09
15x15 Gigacer Shades	146x146	00

## MODULARITY

MODULARITÀ

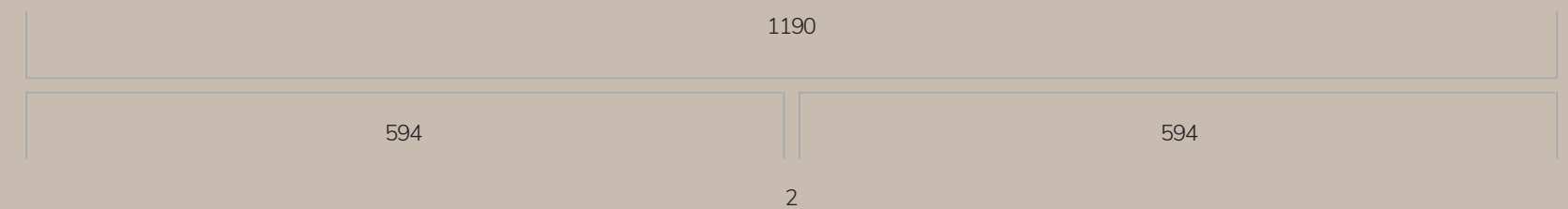

Notes / Note:  
All measurements are expressed in millimetres.  
Tutte le misure sono espresse in millimetri.



# PACKAGING

## IMBALLI

Thickness Spessore	Size (cm) Formato	Pallet (cm)	PCS/BX Pezzi x collo	SQM/BX M <sup>2</sup> x collo	KG/BX Kg x collo	BX/PLT Colli x pallet	SQM/PLT M <sup>2</sup> x pallet	KG/PLT Kg x pallet
24 mm	120x120	120x120	1	1,44	82,00	12	17,28	1010
	60x120	120x120	1	0,72	41,00	24	17,28	1010
	60x60	120x120	1	0,36	20,50	48	17,28	1010
20 mm	60x120	94x122	1	0,72	32,50	24	17,28	850
12 mm through body	120x250 Unrectified	272x133x42h	1	3,00	87,00	12	36,00	1144
	120x250 Rectified	272x133x42h	1	3,00	84,00	12	36,00	1108
12 mm	120x120	120x120	1	1,44	40,30	36	51,84	1482
	60x120	120x120	2	1,44	40,30	36	51,84	1482
	60x60	120x120	3	1,08	30,20	48	51,84	1482
	30x60	120x120	4	0,72	20,20	72	51,84	1482
	15x15	120x120	32	0,72	20,20	64	46,08	1322
	Large Pentagon	-	1	1,00	28,00	36	36,00	1048
	120x120 Quarry	120x120	1	1,44	40,30	36	51,84	1482
	60x120 Quarry	120x120	2	1,44	40,30	36	51,84	1482
	60x60 Quarry	120x120	2	0,72	20,10	72	51,84	1477
	30x60 Quarry	120x120	2	0,36	10,00	144	51,84	1470
	30x30 Quarry	120x120	2	0,18	5,00	288	51,84	1470
	Blend 5-10-15x60	-	12	0,72	20,20	48	34,56	999
	Mix Mosaic 3x3	80x120 euro	8	-	22,50	-	-	-
	Battiscopa . Skirting 60x7,1	-	10	-	12,00	-	-	-
	Gradino costa retta Costa retta step 60x33x4	-	4	-	26,00	-	-	-
	Gradino costa retta Costa retta step 120x33x4	-	2	-	26,00	-	-	-

Thickness Spessore	Size (cm) Formato	Pallet (cm)	PCS/BX Pezzi x collo	SQM/BX M <sup>2</sup> x collo	KG/BX Kg x collo	BX/PLT Colli x pallet	SQM/PLT M <sup>2</sup> x pallet	KG/PLT Kg x pallet
6 mm	120x250	272x133x42h	1	3,00	42,60	22	66,00	1037
	120x120	124x137	2	2,88	41,00	20	57,60	860
	60x120	124x137	4	2,88	40,80	24	69,12	1021
	60x60	124x137	4	1,44	20,50	40	57,60	860
	63,5x11,5 Chevron	80x120 euro	10	0,73	8,00	40	29,20	340
	30x120 LCS1	80x120 euro	2	0,72	10,20	60	43,20	645
	30x60	124x137	8	1,44	20,50	48	69,12	1014
	15x60	80x120 euro	16	1,44	19,00	48	69,12	940
	Large Pentagon	-	1	1,00	14,00	40	40,00	588
	Mosaic Chevron	-	7	-	8,00	-	-	-
	Mosaic 30x30 (1,5x1,5)	-	10	-	10,00	-	-	-
	Stripes Mosaic 30x60	-	6	-	14,00	-	-	-
	Stripes Mosaic 15x120	-	4	-	9,00	-	-	-
	Small	-	44	0,36	4,60	-	-	-
	Brick	-	22	0,36	4,60	-	-	-
	Plate	-	22	0,60	7,70	-	-	-
	Diamond	-	9	0,24	3,25	-	-	-
	Small Pentagon	-	24	0,96	13,50	-	-	-
	Small Hexagon	-	11	0,23	3,00	-	-	-
	Large Hexagon	-	14	1,18	15,00	-	-	-
Battiscopa . Skirting 120x7,1	-	8	-	11,00	-	-	-	
Gradino costa retta Costa retta step 60x33x4	-	4	-	26,00	-	-	-	
Gradino costa retta Costa retta step 120x33x4	-	2	-	26,00	-	-	-	



# PACKAGING

IMBALLI

Thickness Spessore	Size (cm) Formato	Pallet (cm)	PCS/BX Pezzi x collo	SQM/BX M <sup>2</sup> x collo	KG/BX Kg x collo	BX/PLT Colli x pallet	SQM/PLT M <sup>2</sup> x pallet	KG/PLT Kg x pallet
4.8 mm	120x120	124x137	2	2,88	34,60	23	66,24	835
	60x120	124x137	4	2,88	34,60	24	69,12	870
	60x60	124x137	5	1,80	21,60	40	72,00	904
	30x60	124x137	10	1,80	21,60	48	86,40	1067
	30x30	80x120 euro	22	1,98	23,70	40	79,20	980
	15x15	80x120 euro	22	0,50	5,90	112	55,44	690
	Blend 5-10-15x60	-	24	1,44	17,30	48	69,12	860
	Mosaic 30x30 (1,5x1,5)	-	10	-	8,00	-	-	-
	Stripes Mosaic 30x60	-	6	-	11,00	-	-	-
	Stripes Mosaic 15x120	-	4	-	7,00	-	-	-
	Action Mosaic 30x30 (4,4x5,2)	-	10	-	9,00	-	-	-
	Small	-	44	0,36	3,95	-	-	-
	Brick	-	22	0,36	3,95	-	-	-
	Plate	-	22	0,60	6,45	-	-	-
	Diamond	-	9	0,24	2,92	-	-	-
	Small Pentagon	-	24	0,96	11,50	-	-	-
	Small Hexagon	-	11	0,23	3,00	-	-	-
	Large Hexagon	-	14	1,18	13,00	-	-	-
	Battiscopa . Skirting 120x7,1	-	8	-	11,00	-	-	-

# TECHNICAL FEATURES

CARATTERISTICHE TECNICHE

PORCELAIN SLABS / LASTRE DI GRES PORCELLANATO . ISO 13006 - G - Bla UGL (E ≤ 0,5%) UNI EN 14411 - G -					
	TECHNICAL SPECIFICATIONS CARATTERISTICHE TECNICHE	NORMA ISO STANDARD	THICKNESS SPESSORE	INTERNATIONAL STANDARDS VALORI PRESCRITTI DALLE NORME	AVERAGE GIGACER VALUE VALORE MEDIO GIGACER
	DIMENSIONAL CHARACTERISTICS CARATTERISTICHE DIMENSIONALI		-	S > 410	
	SIDES LATI	ISO 10545-2	-	± 0,6%	± 0,2%
	THICKNESS SPESSORE		-	± 5%	± 3%
	STRAIGHTNESS OF EDGES RETTILINEITÀ DEGLI SPIGOLI		-	± 0,5%	± 0,2%
	RECTANGULARITY ORTOGONALITÀ		-	± 0,6%	± 0,2%
	SURFACE FLATNESS PLANARITÀ		-	± 0,5%	± 0,2%
	WATER ABSORPTION ASSORBIMENTO D'ACQUA	ISO 10545-3	-	≤ 0,5%	≤ 0,1%
	BENDING STRENGTH RESISTENZA ALLA FLESSIONE	ISO 10545-4	≠ 4.8 mm	≥ 35N/mm <sup>2</sup>	≥ 40 N/mm <sup>2</sup>
			≠ 6 mm	≥ 35N/mm <sup>2</sup>	≥ 40 N/mm <sup>2</sup>
			≠ 12 mm	≥ 35N/mm <sup>2</sup>	≥ 40 N/mm <sup>2</sup>
			≠ 20 mm	≥ 35N/mm <sup>2</sup>	≥ 50 N/mm <sup>2</sup>
			≠ 24 mm	≥ 35N/mm <sup>2</sup>	≥ 52 N/mm <sup>2</sup> **
	MODULUS OF RUPTURE MODULO DI ROTTURA	ISO 10545-4	≠ 4.8 mm	> 700N (sp. < 7,5mm)	> 700 N
			≠ 6 mm	> 700N (sp. < 7,5mm)	> 700 N
			≠ 12 mm	> 1.300N (sp. ≥ 7,5mm)	≥ 4000 N
			≠ 20 mm	> 1.300N (sp. ≥ 7,5mm)	≥ 13600 N
			≠ 24 mm	> 1.300N (sp. ≥ 7,5mm)	≥ 20000 N**
	RESISTANCE TO DEEP ABRASION RESISTENZA ALL'ABRASIONE PROFONDA	ISO 10545-6	-	≤ 175mm <sup>3</sup>	≤ 145 mm <sup>3</sup>
	COEFFICIENT OF LINEAR THERMAL EXPANSION COEFFICIENTE DI DILATAZIONE TERMICA LINEARE	ISO 10545-8	-	≤ 9x10 6°c 1	≤ 7x10 6°c 1
	RESISTANCE TO THERMAL SHOCKS RESISTENZA AGLI SBALZI TERMICI	-	-	AVAILABLE METHOD METODO DISPONIBILE	RESISTANT RESISTE
	FROST RESISTANCE RESISTENZA AL GELO	ISO 10545-12	-	AVAILABLE METHOD METODO DISPONIBILE	RESISTANT RESISTE
	RESISTANCE TO CHEMICAL ATTACKS RESISTENZA ALL'ATTACCO CHIMICO	ISO 10545-13	-	min. UB	RESISTANT RESISTE
	STAIN RESISTANCE RESISTENZA ALLE MACCHIE	ISO 10545-14	-	AVAILABLE METHOD METODO DISPONIBILE	RESISTANT RESISTE

\*\* Valori calcolati sul formato 30x30 cm. / Measurements made on the 30x30 cm format.



# COEFFICIENT OF FRICTION

COEFFICIENTE DI ATTRITO

PORCELAIN SLABS / LASTRE DI GRES PORCELLANATO . ISO 13006 - G - Bla UGL (E ≤ 0,5%) UNI EN 14411 - G -										
SURFACES SUPERFICI		THICKNESS SPESSORE	DIN EN 16165 Annex B	DIN EN 16165 Annex A	BCR <sup>1</sup>	BRITISH <sup>2</sup> PENDULUM BS7976	UNE <sup>3</sup> 41901:2017 EX (SLIDER 55#)	R9729 UPI/EMPA	DCOF (ANSI A 137.1:2019)	
BETON		±6 mm ±12 mm	-	-	> 0,40	-	-	GS1	> 0,42 wet	
MOLITOR		±6 mm	R10*	-	> 0,40	-	Clase 1	GS1	> 0,42 wet	
		±12 mm ±24 mm	R10	A + B	> 0,40	> 36 WET	Clase 2	GS2/GB1	> 0,42 wet	
ARGILLA	MATERIAL	±6 mm	R10	A + B	> 0,40	-	-	-	-	
CONCEPT 1		MAT	±6 mm	R10	-	> 36 WET	Clase 2	GS1	-	
		TEXTURE MAT	±6 mm	R10	A	-	-	-	-	-
		BOCCIARDATO	±12 mm ±24 mm	R10	A + B	> 0,40	> 36 WET	Clase 2	GS2/GB1	> 0,42 wet
		BOCCIARDATO ANTISLIP	±12 mm ±24 mm	R11	A + B + C	> 0,40	> 36 WET	Clase 3	GS2/GB1	> 0,42 wet
CONCRETE		MAT	±4.8 mm	R10	A + B*	> 0,40	-	Clase 1	GS1	-
			±6 mm	R10	A + B*	> 0,40	-	Clase 1	GS1	-
		±12 mm ±24 mm	R10	A + B	> 0,40	> 36 WET except Ice colour	Clase 2 Ice colour Clase 1	GS2/GB1	> 0,42 wet except Ice colour	
SOFT		±12 mm	R9	-	-	-	Clase 1	GS1	-	
CONCRETE SIGNS		±4.8 mm ±6 mm	R10	A + B*	> 0,40	-	Clase 1	GS1	-	
ELEMENTA		MAT	±6 mm	R10	A + B*	> 0,40	-	Clase 1	GS2/GB1	-
			±12 mm	R10	A + B*	> 0,40	> 36 WET	Clase 2	GS2/GB1	-
		SOFT	±6 mm	R9	-	-	-	Clase 1	GS1	-
BOCCIARDATO		±20 mm	R11	A + B + C	> 0,40	> 36 WET	Clase 3	GS2/GB1	> 0,42 wet	
INCLUSIONI		CLASSICO MAT	±12 mm	R10	A+B*	> 0,40	> 36 WET	Clase 2	GS2/GB1	> 0,42 wet
		SOAVE MAT	±12 mm ±24 mm	R10	A + B*	> 0,40	> 36 WET	Clase 2	GS2/GB1	> 0,42 wet
		SOAVE BOCCIARDATO		R10	A + B	> 0,40	> 36 WET	Clase 2	GS2/GB1	> 0,42 wet
		SOAVE BOCCIARDATO ANTISLIP		R11	A + B + C	> 0,40	> 36 WET	Clase 3	GS2/GB1	> 0,42 wet
KREA		±4.8 mm ±6 mm	R10	A + B*	> 0,40	-	-	GS1	-	
LIGHT		±6 mm	CRESPO	R10	A + B	> 0,40	-	-	GS1	-
			RIGATO	R9	A	> 0,40	-	-	GS1	-
			ROCCIA	R9	A	> 0,40	-	-	GS1	-
			SCOLPITO	R10	A + B	> 0,40	-	-	GS1	-
			GESSO	R9	A	> 0,40	-	-	GS1	-



COEFFICIENT OF FRICTION  
COEFFICIENTE D'ATTRITO

PORCELAIN SLABS / LASTRE DI GRES PORCELLANATO . ISO 13006 - G - Bla UGL (E ≤ 0,5%) UNI EN 14411 - G -										
SURFACES SUPERFICI		THICKNESS SPESSORE	DIN EN 16165 Annex B	DIN EN 16165 Annex A	BCR <sup>1</sup>	BRITISH <sup>2</sup> PENDULUM BS7976	UNE <sup>3</sup> 41901:2017 EX (SLIDER 55#)	R9729 UPI/EMPA	DCOF (ANSI A 137.1:2019)	
COEFFICIENT OF FRICTION COEFFICIENTE D'ATTRITO	MADE 2.0	MAT	±12 mm	R10	-	> 0,40	> 36 WET except Ice colour	Clase 2 Ice colour Clase 1	GS2/GB1	> 0,42 wet except Ice colour
		BOCCIARDATO ANTISLIP	±12 mm ±24 mm	R11	A + B + C	> 0,40	> 36 WET	Clase 3	GS3/GB2	> 0,42 wet
	QUARRY	MAT	±6 mm ±12 mm	R10	A+B	> 0,40	> 36 WET	Clase 2	GS2/GB1	> 0,42 wet
		BOCCIARDATO ANTISLIP	±12 mm ±24 mm	R11	A+B+C	> 0,40	> 36 WET	Clase 3	GS2/GB1	> 0,42 wet
	TERRA	MAT	±6 mm	R10	A+B	-	-	Clase 1	GS1	-
			±12 mm	R10	A+B	-	> 36 WET	Clase 2	GS1	-
LUCIDATO		±6 mm	R9	-	-	-	Clase 1	GS1	-	



COEFFICIENT OF FRICTION  
COEFFICIENTE D'ATTRITO

\* Valore medio. / Average value.

The values of slip resistance and of static and dynamic friction coefficient shown in the catalogue, and in the web site are merely indicative and non-binding. Any possible specific requirement must be confirmed by us at the order and anyway always before the installation. / I valori di resistenza allo scivolamento, coefficiente di attrito statico e dinamico, riportati sul catalogo e sul sito, sono da ritenersi puramente indicativi e non vincolanti. Ogni eventuale specifica necessità dovrà essere da noi confermata al momento dell'ordine e comunque sempre prima della posa.

We produce technical unglazed porcelain stoneware slabs, and some light impurities and dots must be considered as a standard feature of the product. / Trattandosi di un prodotto tecnico a solo impasto senza smalto alcune impurità e puntature visibili nei colori chiari sono da considerarsi una caratteristica tecnica del prodotto.

\*\* Valori calcolati sul formato 30x30 cm. / Measurements made on the 30x30 cm format.



# CERTIFICATIONS

## CERTIFICAZIONI

Gigacer has achieved the process certifications ISO 9001:2015 e ISO 14001:2015.

Gigacer has achieved the process certifications UNI EN 14411:2012.

The quality of Gigacer products is constantly monitored with tests made by the main international certification laboratories.

It is possible to download the list of Gigacer products that obtained:

- QB-UPEC certification with all the values at the following url [www.cstb.fr](http://www.cstb.fr)

- CERTIQUALITY certification at the following url [www.certiquality.it](http://www.certiquality.it)

GIGACER ha conseguito le certificazioni di processo ISO 9001:2015 e ISO 14001:2015.

Gigacer ha conseguito le certificazioni UNI EN 14411:2012.

La qualità dei prodotti Gigacer viene controllata costantemente tramite test effettuati dai principali laboratori ed enti di certificazione internazionali.

E' possibile scaricare la lista completa dei prodotti Gigacer che hanno ottenuto:

- la certificazione QB-UPEC, completa di valori, al seguente url [www.cstb.fr](http://www.cstb.fr)

- la certificazione CERTIQUALITY al seguente url [www.certiquality.it](http://www.certiquality.it)

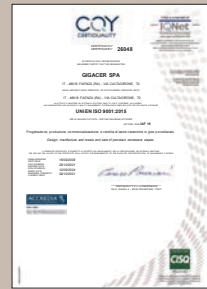

Gigacer products do not damage with chemical detergents anticovid.  
I prodotti Gigacer non si danneggiano con i detersivi chimici anticovid.





GIGACER S.P.A.

Via Caltagirone, n.72 - 48018 Faenza (RA) ITALY  
Tel. +39 0546 637 111 - Fax +39 0546 637 127  
info@gigacer.it - www.gigacer.it

